

**BUILT-IN HOUSEHOLD APPLIANCES**  
2019 - 2020



**VESTEL**

[www.vestelinternational.com](http://www.vestelinternational.com)







## **COMPANY PROFILE**

2-3

## **GLOBAL OPERATIONS**

4-5

## **REFRIGERATORS**

6-25

## **60 CM DISHWASHERS**

26-91

## **45 CM DISHWASHERS**

92-131

## **OVENS**

132-190

## **HOBS**

191-252

## **SPECIFICATIONS**

253-330

## **ADDRESSES**

333



## COMPANY PROFILE

# Vestel City, which comprises nine plants located in Manisa, is amongst the biggest industrial complexes of the world.

Vestel City, which comprises nine plants located in Manisa, is amongst the biggest industrial complexes of the world.

As one of the leading enterprises in Turkey, Vestel is a major player in consumer electronics, mobile technologies, household appliances, professional displays and LED lighting with renowned products, including refrigerators, washing machines, tumble dryers, cooking appliances, dishwashers, air conditioners, water heaters, television sets, educational, hospitality

and digital signage solutions, digital set-top boxes, tablet PCs, and smart phones.

The company is recognized for its cutting-edge designs, high product quality, large production capacity, and superior market share growth.

Vestel is one of the ten biggest household appliance manufacturers in Europe, with its new product development ability, flexibility in production, and fast response to clients' demands.

Operating with an annual capacity of 3.2 million units,

the company's two refrigerator plants produce a variety of models ranging from french door, no-frost, combi, double door, single door, to table top Fridges and Freezers, as well as built-in models.

Achieving similar success with washing machines, Vestel is able to produce 2.6 million units a year, with models ranging from 4 kg to 9 kg drum capacities. The group added washer dryers to the product range in 2012. The new plant, consists of washer and dryer production lines, has started manufacturing in





**1.100.000 m<sup>2</sup>**  
Closed Production Area



**35 Million**  
Device Production  
Capacity



**16.000**  
Employees



**\$ 4 Billion**  
Turnover



**10,9 Million**  
Home Appliances  
Production Capacity



Export Leader of Turkey with  
**\$ 2,5 Billion**

2018 with a 750K capacity for dryers and 750K additional capacity for washers. The plant for cooking appliances operates with an annual capacity of 2.2 million units, producing free-standing cookers, built-in hobs and ovens.

The household appliances product range includes free standing, semi and fully integrated dishwashers. The plant has the capacity to produce 2.5 million units a year.

In addition, the air conditioner factory is capable of

producing 750, 000 units of split-type models.

Vestel is the first company in Turkey operating two manufacturing plants in Russia for the production refrigerators, washing machines, and televisions with the aim of becoming a leader in CIS countries.

Vestel Trade, the company responsible for the marketing and sales of Vestel products overseas, exports 73% percent of its production under leading Japanese and European brands to 155 countries.

Vestel Trade has achieved export sales of 8.3 million units of electronics and 4.8 million units of household appliances.

Distributing its products to seven continents, Vestel takes its place as a world-class company.





## **GLOBAL OPERATIONS**

### **Manufacturing & Assembly Plants**

**TV, Set-top Boxes**

**Manisa, Turkey**

**Professional Displays, Tablet PC, Smart Phone, LED lighting**

**Manisa, Turkey**

**Refrigerator, Washing Machine, Dishwasher, Tumble Dryer, Cooking Appliances,  
Air Conditioner, Water Heater**

**Manisa, Turkey**





## **Marketing & Sales Companies**

**Vestel Trade, Turkey**  
**Vestel France, France**  
**Vestel Germany, Germany**  
**Vestel UK, United Kingdom**  
**Vestel Iberia, Spain**  
**Vestel Poland, Poland**

**Vestel Benelux, Netherlands**  
**Vestel CIS Ltd, Russia**  
**Vestel Electronica, Romania**  
**Vestel Central Asia, Kazakhstan**  
**Vestel Electronics Gulf, Dubai**

## **R&D Centers**

**Manisa, Turkey**  
**Istanbul, Turkey**  
**Bristol, United Kingdom**  
**Shanghai, China**



## Refrigerators





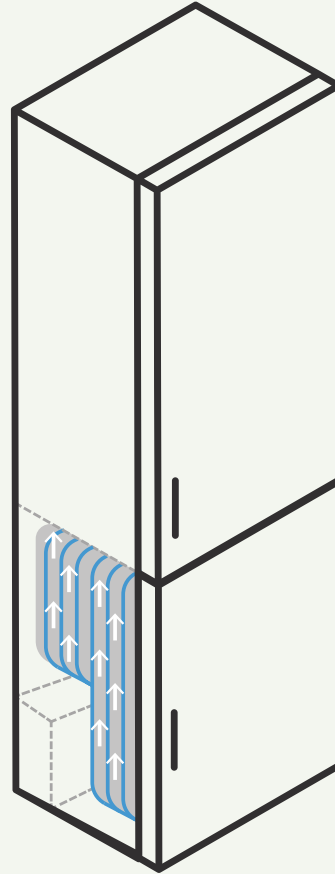

## Less Frost

Thanks to the wrap around evaporator, LessFrost technology offers more efficient cooling, less manual defrost requirement, and more flexible storage room.



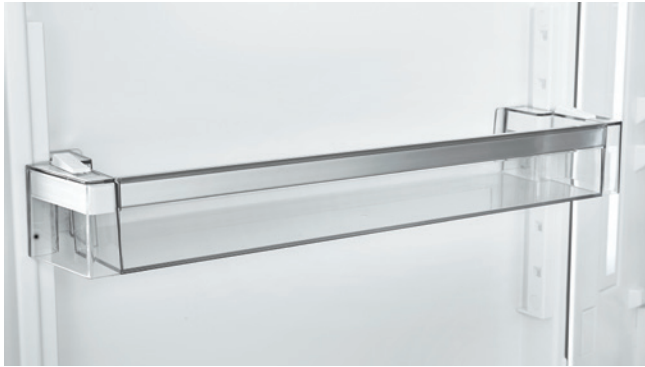

## V-Lift

With the adjustable height mechanism, height of bottle shelf can be maximized for higher bottles or can be reduced to save space for the dairy shelf. Position of rack can be set to **6** different height.



## Sliding Tray

Thanks to the sliding mechanism, it provides ease of use in the freezer compartment.



## Ice Slide

Provides convenient storage spaces with a simple movement. The slide icematic ensures flexible storage and max capacity anytime you need.



## Door Reversible

Depending on the location of your refrigerator, you can adjust door opening direction thanks to the reversible door feature.



## Easy Lock Freezer

Mechanism of the handle enables easy opening and closing of the door. Red mark on the door indicates and warns the user when the Freezer door is left open.





### Humidity Controlled Crisper

Thanks to air channels and special filter, humidity level can be adjusted precisely to keep your fruits and vegetables fresh and crisp.



### Door On Door Models

Cabinet door is mounted directly onto the refrigerator door and with the help of the hinge, the refrigerator opens wider and closes automatically.



### Maxi-fresh Preserver

Maxi Fresh Preserver technology helps keeping food fresh longer time by absorbing ethylene gas (a bioproduct released naturally from fresh foods) and unpleasant odors from the crisper.



### Sliding Door Models

Cabinet door is Connected to the refrigerator door with sliding rails.

## DISPLAYS



**LED Touch HP Display**



**Push Button HP Display**



**Inner Display**



2795

### **Technical Data**

#### **Energy Class**

A++/A+

#### **Gross/Net Volume**

303 lt / 300 lt

#### **Product Dimensions (WxDxH mm)**

1770 x 540 x 545

### **Built In – Single Door**

Niche 1780mm

Sliding door

Door on Door

Reversible doors



### **Standard Configuration**

- Turbo fan air cooling
- Air Duct
- Safety Glass Shelves
- 1 Glass Shelf over Crisper
- 2 Crispers
- Automatic Defrosting
- Humidity Controller
- 1 Dairy Rack
- 1 Egg Holder
- 4 Transparent shelves
- 1 Bottle Shelf

### **Optional Features**

- Electronic Head Panel Display
- LED Lighting
- Wine Shelf
- V-Lift
- MaxiFresh Preserver
- LED Touch Button Display
- Hotstamp on the Glass Shelves
- Hotstamp Add-on on the Door Racks
- LED Touch HP Display
- Push Button HP Display

2791

### **Technical Data**

#### **Energy Class**

A++/A+

#### **Gross/Net Volume**

221 lt / 197 lt

#### **Product Dimensions (WxDxH mm)**

1770 x 540 x 545

### **Built In – Single Door**

Niche 1780mm

Sliding door

Door on Door

Reversible doors



### **Standard Configuration**

Nofrost

4 Star Freezer

6 Freezer Compartments

2 Flaps

LED Lighting

### **Optional Features**

Sliding Icematic

LED Touch Button Display

Hotstamp on the Glass Shelves

Hotstamp Add-on on the Door Racks

LED Touch HP Display

Push Button HP Display



2 7 6 1

## Technical Data

### Energy Class

A++/A+

### Gross/Net Volume

256 lt / 243 lt

### Product Dimensions (WxDxH mm)

1770 x 540 x 545

### Net Frigde/Freezer Volume

180 lt / 63 lt

## Built In – Double Door

Niche 1780mm

Sliding door

Door on Door

Reversible doors



## Standard Configuration

- Turbo fan air cooling
- 4 Star Freezer
- 1 Ice Box
- 3 Freezer Compartments
- Safety Glass Shelves
- 1 Crisper
- 1 Glass Shelf over Crisper
- Automatic Defrosting
- Humidity Controller
- LED Lighting
- 1 Dairy Rack
- 1 Egg Holder
- 3 Transparent Shelves
- 1 Bottle Shelf

## Optional Features

- Electronic Head Panel Display
- Wine Shelf
- V-Lift
- MaxiFresh Preserver
- LED Touch Button Display
- Sliding Tray
- Hotstamp on the Glass Shelves
- Hotstamp Add-on on the Door Racks
- LED Touch HP Display
- Push Button HP Display

2 7 6 0

## Technical Data

### Energy Class

A++/A+

### Gross/Net Volume

256 lt / 251 lt

### Product Dimensions (WxDxH mm)

1770 x 540 x 545

### Net Frigide/Freezer Volume

181 lt / 70 lt

## Built In – Double Door

Niche 1780mm

Sliding door

Door on Door

Reversible doors



## Standard Configuration

- 4 Star Freezer
- 1 Ice Box
- 3 Freezer Compartments
- Safety Glass Shelves
- 1 Crisper
- 1 Glass Shelf over Crisper
- Humidity Controller
- LED Bulb Lighting
- 1 Dairy Rack
- 1 Egg Holder
- 3 Transparent Shelves
- 1 Bottle Shelf

## Optional Features

- Wine Shelf
- V-Lift
- MaxiFresh Preserver
- Sliding Tray
- Hotstamp on the Glass Shelves
- Hotstamp Add-on on the Door
- Racks



2751

### Technical Data

#### Energy Class

A++/A+

#### Gross/Net Volume

249 lt / 233 lt

#### Product Dimensions (WxDxH mm)

1770 x 540 x 545

#### Net Frigde/Freezer Volume

147 lt / 186 lt

### Built In – Double Door

Niche 1780mm

Sliding door

Door on Door

Reversible doors



### Standard Configuration

- Turbo fan air cooling
- 4 Star Freezer
- 1 Ice Box
- 4 Freezer Compartments
- Safety Glass Shelves
- 1 Crisper
- 1 Glass Shelf over Crisper
- Automatic Defrosting
- Humidity Controller
- LED Lighting
- 1 Dairy Rack
- 1 Egg Holder
- 3 Transparent Shelves
- 1 Bottle Shelf

### Optional Features

- Electronic Head Panel Display
- Wine Shelf
- V-Lift
- MaxiFresh Preserver
- LED Touch Button Display
- Sliding Tray
- Hotstamp on the Glass Shelves
- Hotstamp Add-on on the Door Racks
- LED Touch HP Display
- Push Button HP Display

2 7 5 0

## Technical Data

### Energy Class

A++/A+

### Gross/Net Volume

249 lt / 242 lt

### Product Dimensions (WxDxH mm)

1770 x 540 x 545

### Net Frigide/Freezer Volume

148 lt / 94 lt

## Built In – Double Door

Niche 1780mm

Sliding door

Door on Door

Reversible doors



## Standard Configuration

- 4 Star Freezer
- 1 Ice Box
- 4 Freezer Compartments
- Safety Glass Shelves
- 1 Crisper
- 1 Glass Shelf over Crisper
- Humidity Controller
- LED Bulb Lighting
- 1 Dairy Rack
- 1 Egg Holder
- 3 Transparent Shelves
- 1 Bottle Shelf

## Optional Features

- Wine Shelf
- V-Lift
- MaxiFresh Preserver
- Sliding Tray
- Hotstamp on the Glass Shelves
- Hotstamp Add-on on the Door Racks



2 6 1 0

### **Technical Data**

**Energy Class**  
A+++/A+

**Gross/Net Volume**  
217 lt / 214 lt

**Product Dimensions (WxDxH mm)**  
1445 x 540 x 545

**Net Frigde/Freezer Volume**  
176 lt / 38 lt

### **Built In – Double Door**

Niche 1450 mm

Sliding door

Door on Door

Reversible doors



### **Standard Configuration**

- 4 Star Freezer
- 1 Ice Box
- 3 Removable Shelves
- Safety Glass Shelves
- 1 Glass Shelf over Crisper
- 2 Crispers
- 1 Dairy Rack
- 1 Egg Holder
- 3 Transparent Shelves
- 1 Bottle Shelf

### **Optional Features**

- Hotstamp Add-on on the Door Racks
- Wine Shelf

2 3 0 0

### **Technical Data**

**Energy Class**

A++/A+

**Gross/Net Volume**

173 lt / 172 lt

**Product Dimensions (WxDxH mm)**

1218 x 540 x 545

**Net Frigde/Freezer Volume**

134 lt / 38 lt

### **Built In – Double Door**

Niche 1235 mm

Sliding Door

Reversible doors



### **Standard Configuration**

- Mechanical Control
- LED Bulb Lighting
- Tempered Glass Shelves
- 2 Door Racks
- 1 Bottle Shelf
- Egg Holders

### **Optional Features**

- Hotstamp on the Glass Shelves
- Hotstamp Add-on on the Door
- Racks
- Wine Shelf
- V-Lift



2 4 6 0

### **Technical Data**

#### **Energy Class**

A+/A++

#### **Gross/Net Volume**

210 lt / 206 lt

#### **Product Dimensions (WxDxH mm)**

1440 x 540 x 545

### **Built In – Double Door**

Niche 1455 mm

Sliding Door

Reversible doors



### **Standard Configuration**

- Mechanical Control
- Led Bulb Lighting
- Crisper
- Tempered Glass Shelves
- 2 Door Racks
- 1 Bottle Shelf
- Egg Holders
- Humidity Controller

### **Optional Features**

- Single Control Inner Display
- Led Lighting On Top
- Wine Shelf
- Maxi Fresh Tech
- V-Lift
- Hotstamp on the Glass Shelves
- Hotstamp Add-on on the Door Racks
- Inner Display

## 2500

### Technical Data

#### Energy Class

A++ / A+ / A

#### Gross/Net Volume

206 lt / 204 lt

#### Product Dimensions (WxDxH mm)

1225 x 540 x 545

### Standard Configuration

4 Removable Shelves  
Safety Glass Shelves  
1 Glass Shelf Over Crisper  
2 Crispers  
1 Dairy Rack  
1 Egg Holder  
1 Bottle Shelf

### Built In – Single Door

Niche 1230 mm

Sliding Door

Door on Door

Reversible doors

### Optional Features

Hotstamp Add-on on the Door Racks  
Wine Shelf



## 2400

### Technical Data

#### Energy Class

A++ / A+ / A

#### Gross/Net Volume

195 lt / 192 lt

#### Product Dimensions (WxDxH mm)

1225x540x545

#### Net Fridge / Freezer Volume

175 lt / 17 lt

### Standard Configuration

4 Star Freezer Compartment  
Freezer Door Indicator  
1 Ice Box  
3 Removable Shelves  
Safety Glass Shelves  
1 Glass Shelf Over Crisper  
2 Crispers

### Built In – Double Door

Niche 1230 mm

Sliding door

Door on Door

Reversible doors

1 Dairy Rack  
1 Egg Holder  
1 Bottle Shelf

### Optional Features

Hotstamp Add-on on the Door Racks  
Wine Shelf





## 1900

### Technical Data

#### Energy Class

A++ / A+ / A

#### Gross/Net Volume

162 lt / 160 lt

#### Product Dimensions (WxDxH mm)

1020 x 540 x 545

### Standard Configuration

- 3 Removable Shelves
- Safety Glass Shelves
- 1 Glass Shelf Over Crisper
- 2 Crispers
- 1 Dairy Rack
- 1 Egg Holder
- 1 Bottle Shelf

### Built In – Single Door

Niche 1030 mm

Sliding Door

Door on Door

Reversible doors

### Optional Features

- Hotstamp Add-on on the Door
- Racks
- Wine Shelf



## 1800

### Technical Data

#### Energy Class

A++ / A+ / A

#### Gross/Net Volume

153 lt / 150 lt

#### Product Dimensions (WxDxH mm)

1020 x 540 x 545

#### Net Fridge / Freezer Volume

133 lt / 17 lt

### Standard Configuration

- 4 Star Freezer Compartment
- Freezer Door Indicator
- 1 Ice Box
- 2 Removable Shelves
- Safety Glass Shelves
- 1 Glass Shelf Over Crisper
- 2 Crispers
- 1 Dairy Rack

### Built In – Double Door

Niche 1030 mm

Sliding door

Door on Door

Reversible doors

### Optional Features

- 1 Egg Holder
- 1 Bottle Shelf
- Hotstamp Add-on on the Door
- Racks
- Wine Shelf



## 1700

### Technical Data

#### Energy Class

A+ / A

#### Gross/Net Volume

136 lt / 133 lt

#### Product Dimensions (WxDxH mm)

818 x 595 x 548

### Built In – Single Door

Niche 820 mm

Door On Door

Reversible Door



### Standard Configuration

2 Removable Shelves

1 Glass Shelf over Crisper

1 Crisper

Spill Proof Safety Glass Shelves

1 Transparent Shelf

1 Egg Holder

1 Bottle Shelf

### Optional Features

Hotstamp on the Glass Shelves

Hotstamp Add-on on the Door Racks

Wine Shelf

## 1650

### Technical Data

#### Energy Class

A+ / A

#### Gross/Net Volume

107 lt / 93 lt

#### Product Dimensions (WxDxH mm)

818 x 595 x 548

### Standard Configuration

4 Star Freezer

3 Freezer Compartments

1 Ice Box

Manual Defrost

Control Panel

Quick Freeze

Mains On

Temperature Rise Warning



### Built In – Single Door

Niche 820 mm

Door On Door

Reversible Door



## 1 6 0 0

### Technical Data

#### Energy Class

A+

#### Gross/Net Volume

120 lt / 115 lt

#### Product Dimensions (WxDxH mm)

98 lt / 17 lt

#### Net Fridge / Freezer Volume

818 x 595 x 548

### Built In – Double Door

Niche 820 mm

Door On Door

Reversible Door



### Standard Configuration

- 1 Removable Shelf
- 1 Glass Shelf over Crisper
- 1 Crisper
- Safety Glass Shelves
- 1 Transparent Shelf
- 1 Egg Holder
- 1 Bottle Shelf

### Optional Features

- Hotstamp on the Glass Shelves
- Hotstamp Add-on on the Door
- Racks
- Wine Shelf

## 1 5 0 0

### Technical Data

#### Energy Class

A++ / A+ / A

#### Gross/Net Volume

135 lt / 134 lt

#### Product Dimensions (WxDxH mm)

875 x 540 x 545

### Built In – Single Door

Niche 880 mm

Sliding Door

Door on Door

Reversible doors



### Standard Configuration

- 3 Removable Shelves
- Safety Glass Shelves
- 1 Glass Shelf over Crisper
- 2 Crispers
- 1 Dairy Rack
- 1 Egg Holder
- 1 Transparent Shelves
- 1 Bottle Shelf

### Optional Features

- Hotstamp Add-on on the Door Racks
- Wine Shelf

## 1 4 5 0

### Technical Data

#### Energy Class

A++ / A+ / A

#### Gross/Net Volume

109 lt / 99 lt

#### Product Dimensions (WxDxH mm)

875 x 540 x 545

### Standard Configuration

4 Star Freezer  
4 Freezer Compartments  
1 Ice Box  
Manual Defrost  
Control Panel  
Quick Freeze  
Mains On  
Temperature Rise Warning

### Built In – Single Door

Niche 880 mm  
Sliding Door  
Door on Door  
Reversible doors



## 1 4 0 0

### Technical Data

#### Energy Class

A++ / A+ / A

#### Gross/Net Volume

126 lt / 123 lt

#### Product Dimensions (WxDxH mm)

875 x 540 x 545

### Standard Configuration

4 Star Freezer Compartment  
Freezer Door Indicator  
1 Ice Box  
2 Removable Shelves  
Safety Glass Shelves  
1 Glass Shelf over Crisper  
2 Crispers  
1 Dairy Rack  
1 Egg Holder

### Built In – Double Door

Niche 880 mm  
Sliding door  
Door on Door  
Reversible doors



### Optional Features

Hotstamp Add-on on the Door Racks  
Wine Shelf



**\*820-828 for metal top cover**

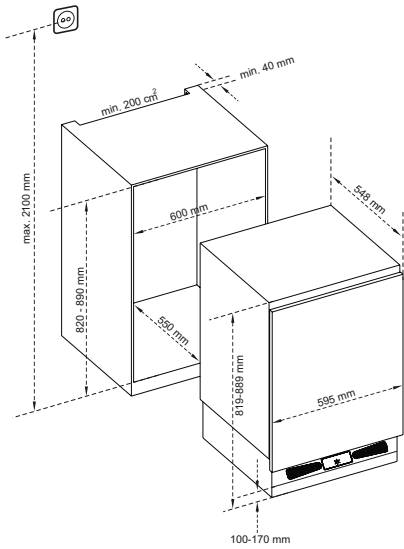

1600 / 1650 / 1700

**\*875-883 for metal top cover**

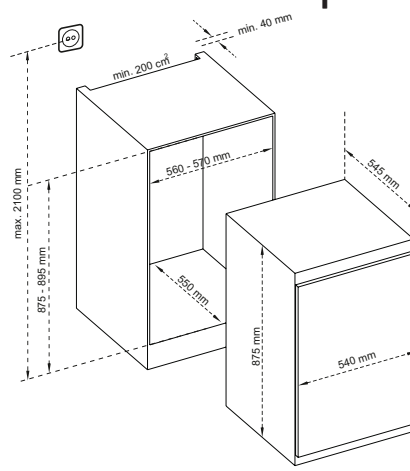

1400 / 1450 / 1500

**\*1020-1028 for metal top cover**

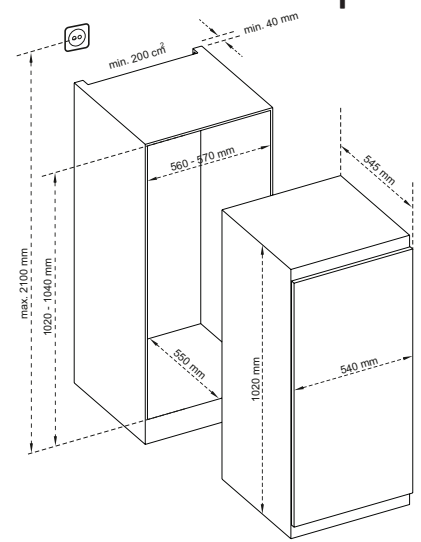

1800 / 1900

**\*1225-1233 for metal top cover**

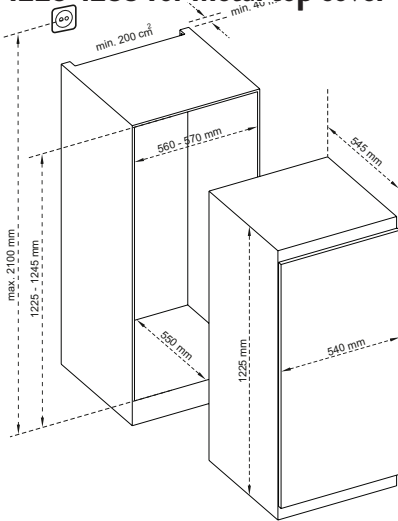

2400 / 2500

**\*1770-1778 for metal top cover**

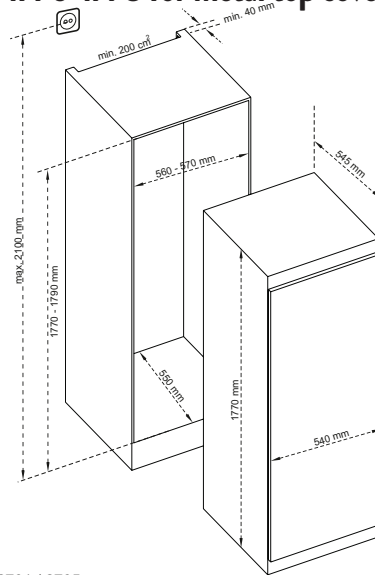

2791 / 2795

**\*1445-1453 for metal top cover**

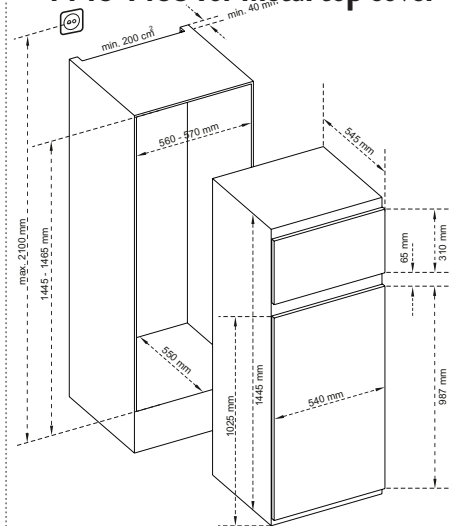

2610

**\*1770-1778 for metal top cover**

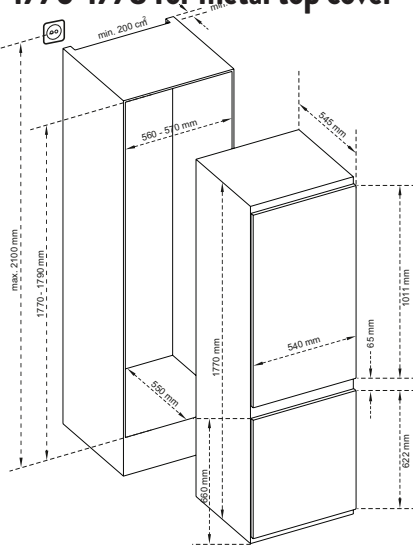

3200

**\*1770-1778 for metal top cover**

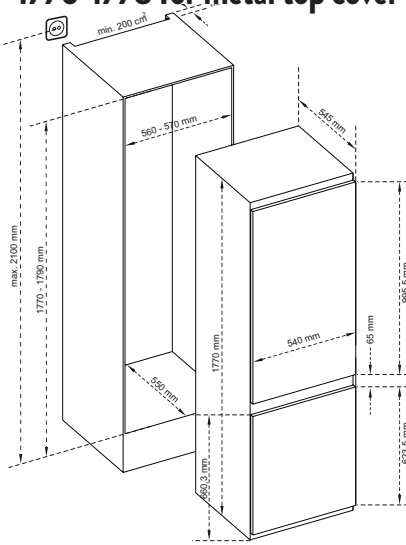

2760 / 2761

**\*1770-1778 for metal top cover**

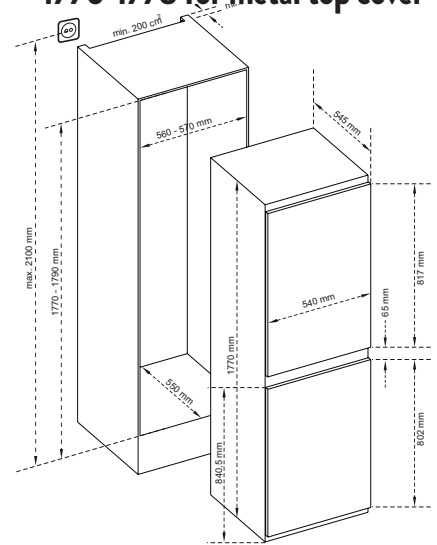

2750 / 2751

*Built-in*  
**Dishwashers**







## Steam Wash

Steam wash technology softening the most stubborn dirt by steam power. High temperature and directly applied steam ensure perfect hygiene and gentle cleaning for your sensitive dishes.



## Smart Wash

Turbidity sensor detects the amount of turbidity in water and adjusts the washing cycle parameters (temperature, duration, amount of water) accordingly.



## Extra Drying

It is possible to have better drying performance with extra drying option. This option increases water temperature at final rinse step and drying step duration up to 10 min.



## Extra Fast

Extra fast option decreases program duration while it is increasing water temperature and pressure to ensure high washing quality in a shorter duration.



## Hygienic Wash

Extra hygiene option which is developed for Vestel Dishwashers ensures a maximum hygiene with high temperature washing. It increases water temperature at final rinse step in order to eliminate bacteria up to %99.9999.



## QuickClean

VESTEL dishwashers achieves A class cleaning performance with advanced cleaning program in only 50 min without diverter. You can save time with this program. It is the first and unique dishwasher that achieves A class cleaning performance in only 50 minutes for standard soiled dishes according to EN standards.



## Extra Rinse

Extra rinse option adds an extra rinse step to achieve more hygienic washing. Program duration is increased between min. %4 and max. %16 according to the washing program.



## Antibacterial Filter

By using Antibacterial PP Sump Filter bacterial growth on the filter surface eliminated up to 99%.



## Tablet Option

With this option, water reaches optimum temperature to dissolve the combined detergent ideally and eliminates such drawbacks and assures maximum performance when tablet detergents are used.



## DualPro Wash

Advanced pump technology allows for one wash to be cleaned at two separate water pressures. Baked on food doesn't stand a chance in the bottom while the delicate glasses in the top are gently being washed.



## Hydro Power

This technology enables all other options and program to save water, energy and time. Also by changing water pressure noise level can be reduced to have more silent washing with BLDC pump technology.



## Half Load

Eco Friendly Half Load technology provides washing performance when dishwasher is not fully loaded, only lower basket or upper basket or both are used with half load if necessary by using half load option. Half Load technology saves energy and water by reducing energy and water consumption due to load options.



## Delay Timer

The start time of a program can be delayed, e.g. to benefit from economy rates of electricity. A delay start time of between 1 hour and 24 hours can be selected.



## Vario Space

VarioSpace is a general feature that gives many options to the end user regarding lower and upper basket variations.



## Child Lock

Child lock option never allows your children to play with your dishwasher. It allows you to lock the buttons on the control panel to be able to restrict the functionality of buttons.



## JetWash

With this fast program, you can clean the dishes like less and/or recently soiled (coffee, milk and tea etc.) in only 14 minutes. This program is one of the fastest programs in the world. It cleans your dishes with 4 place settings capacity in 14 minutes.





## Heater Safety Protection

In case of lack of water, with the help of a pressure switch, the resistance is prevented from being in operation. So both the resistance and the machine itself are protected.



## Overflow and Leakage Protection

The dishwasher activates overflow mode when there is too much water in the dishwasher and the excess water gets drained. It also detects leaks in the base of the dishwasher, shuts down operation and automatically pumps out water before reaching to floor. The unit can auto reset the overflow mode until the water level in the basement cover reaches a certain level.



### 3<sup>rd</sup> Rack

*Eco/Easy/Comfort Tray*

#### Comfort Tray

High-end side by side sliding basket structure for 60 cm range providing up to 15 place setting capacity.

#### Eco Tray

New fixed design option for 3rd rack that provides up to 15 place setting.

#### Easy Tray

The upper cutlery basket is designed to place forks, spoons and knives, long dippers and small items. It is possible to take out the dishes along with the 3rd rack after washing. The Upper Cutlery Basket is composed of two pieces; You can take out left or right part of the upper cutlery basket to obtain more space for the dishes in the upper basket



### Mini Active Drying System

Mini active drying system provides basic drying performance on dishes with its mini fins.



### Super Active Drying System

A portion of the washtub wall is a heat exchanger which, at the end of the rinsing cycle, promotes condensation of the water inside the tub, and hence drying of the dishes.



### Turbo Drying System

It activates a fan which draws steam out of the dishwasher cabinet. Air circulation is much more forced, hence results in most efficient drying performance.



**Top Nozzle**



**Impeller**

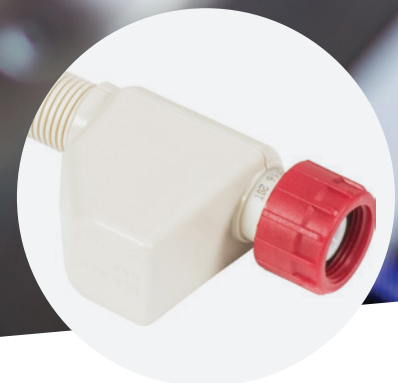

**Aqua Stop**



**Plastic Filter (Optional)**



**Stainless Steel Filter (Default)**



**Anti Bacterial Filter (Optional)**

***Pop-in-pop-out-knob for semi integrated dishwasher***





### Adjustable Rear Foot From The Front



### Front Decor Fixations Different Weights



### Adjustable Plinth

0-100 mm dept adjustment  
820-870 mm machine  
height adjustment  
with high feet

The machine can be  
elevated by 50 mm  
(820 → 870-920 mm  
with high feet)

### High Feet

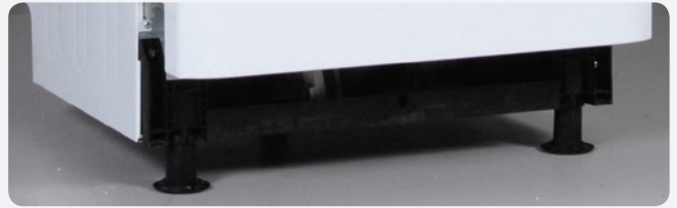

### Interior Lighting

1 spot

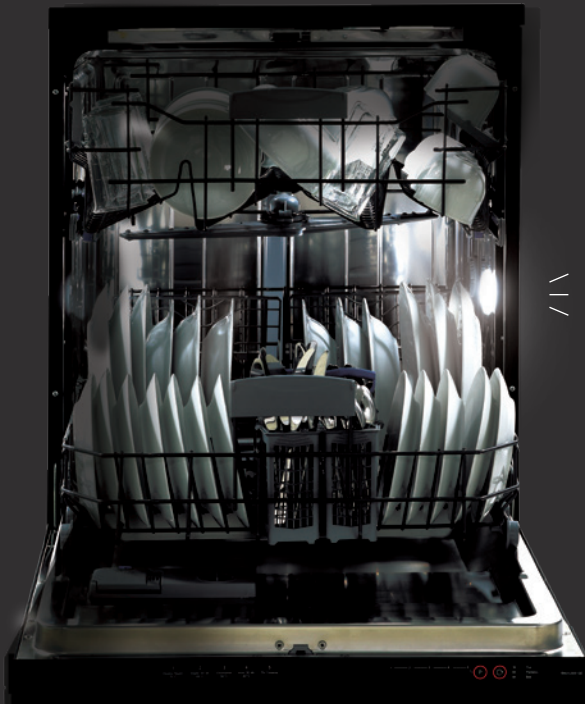

4 spots





## INFOLED 2.0

New floor reflection will be introduced for built-in range\*



*\* Available in April 2020 for both 45 and 60 cm ranges.*

## COLOR OPTIONS

### Semi-Integrated Panel Color Options

#### WHITE



#### BLACK



#### INOX



#### ALUMINIUM LOOK



#### DARK SILVER



#### WHITE



#### BLACK



#### WHITE



#### BLACK



#### DARK SILVER



### Fully-Integrated Panel Color Options

#### WHITE

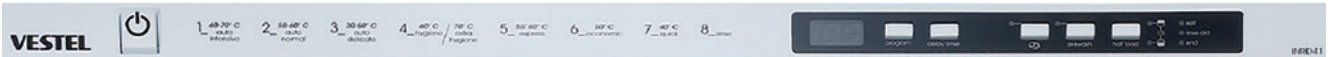

#### BLACK



#### DARK SILVER



#### INOX LOOK



For each aesthetics, please ask for different color options.



## INTEGRATED INOX OPTIONS



***Inox cladding***



***Inox half cladding***



***Inox add-on***

Available for 60 and 45 cm ranges

## INTEGRATED DARK INOX OPTIONS



***Dark inox cladding***



***Dark inox half cladding***



***Dark inox add-on***

Available for 60 and 45 cm ranges





***Semi-integrated***





***Integrated***



## 60 cm Dishwashers

*Semi-integrated & Integrated Ranges*





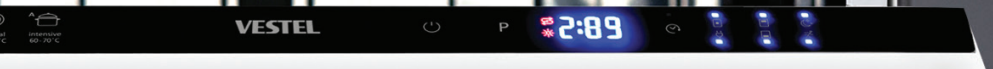



BASKET TYPES

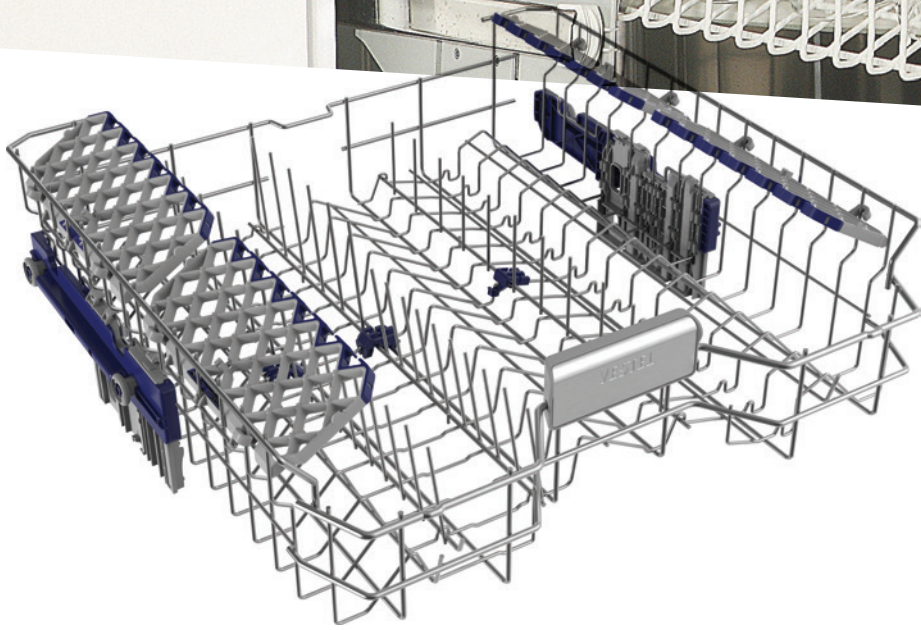

**V-type baskets**



**with ion tech**



**with uvon tech**



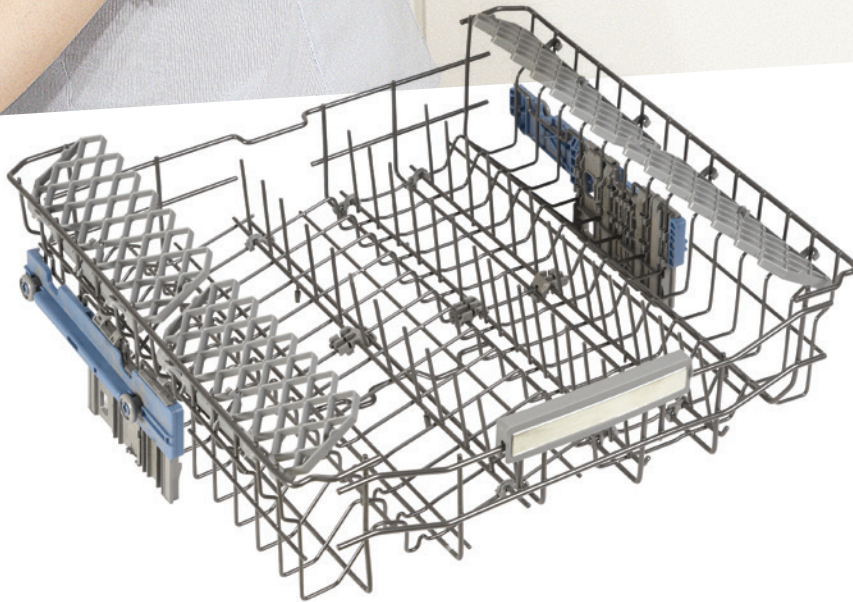

***Flat-type baskets***



**with ion tech**



**with uvon tech**





## Vario Space



### Upper basket



**Adjustable Mug Shelves**



**Spoon Rack and Glass Support**  
only for mesh type upper basket



**Adjustable Upper Basket with Load**  
2 and 3 level high adjustment options



**Adjustable Upper Basket without Load**



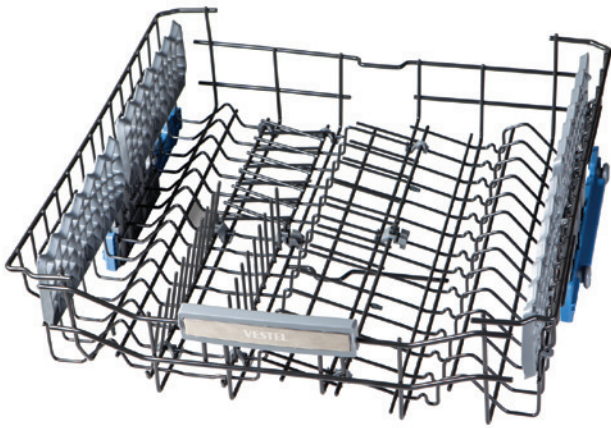

**Foldable Wire**



**Handle with Customized Logo**  
\* For 15 place settings and only for upper basket

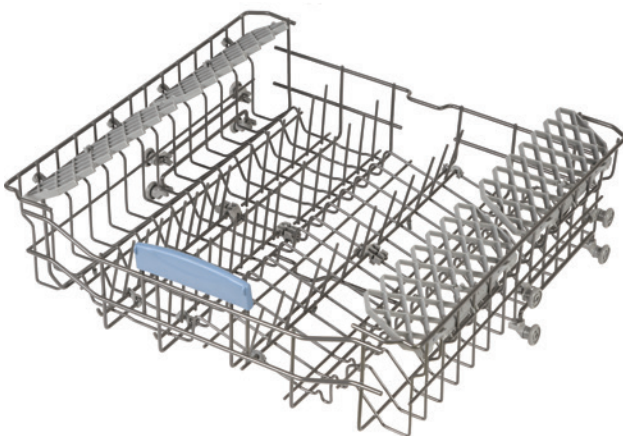

**Plastic Handle**

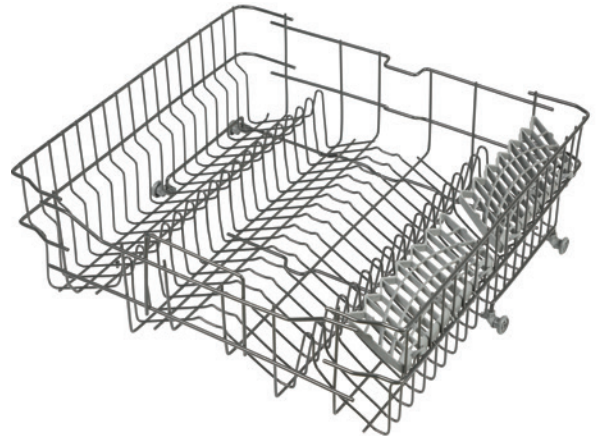

**Wire Handle**





# Vario Space



## Lower basket



**Foldable Wire**  
(2 Or 4)



**Multi-Functional Kit For Lower Basket**

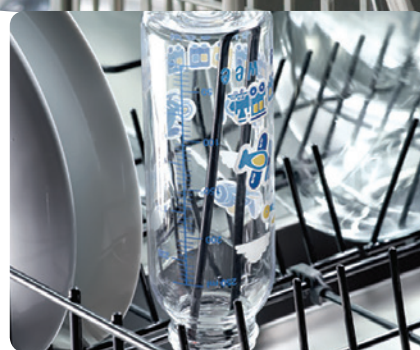

**Bottle Holder**



**Plastic Handle**



**Wine Glass Holder**



**Mug Shelf Support**  
*\*W/Or W/O Soft Touch*

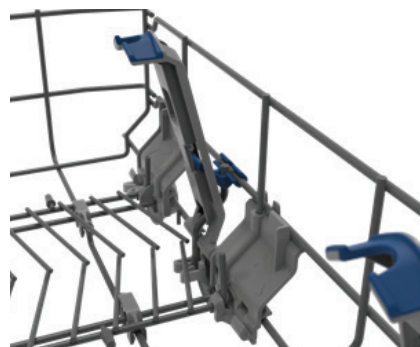

**Tray Holder**



**Standard Cutlery Basket**  
(fixed)



**Modular Cutlery Basket**  
(for 12 Settings)



**Universal Cutlery Basket**



**Sliding Cutlery Basket**



**Sliding Cutlery Basket**  
(with blue color add-on)

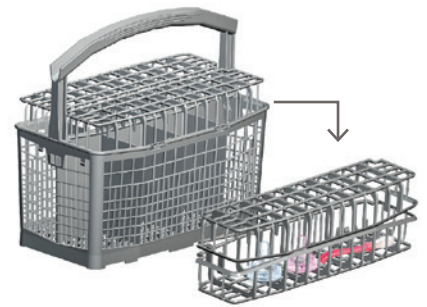

**Hygiene Box\***





 **3<sup>rd</sup> Rack**  
*Comfort Tray*

**New side by side sliding design option for 3rd rack that provides up to 15 place setting.**

\*Cutlerly basket is optional

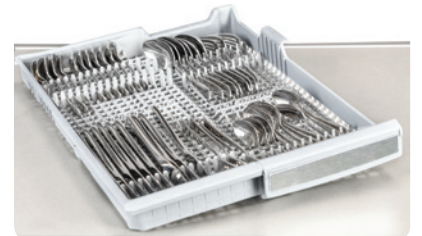
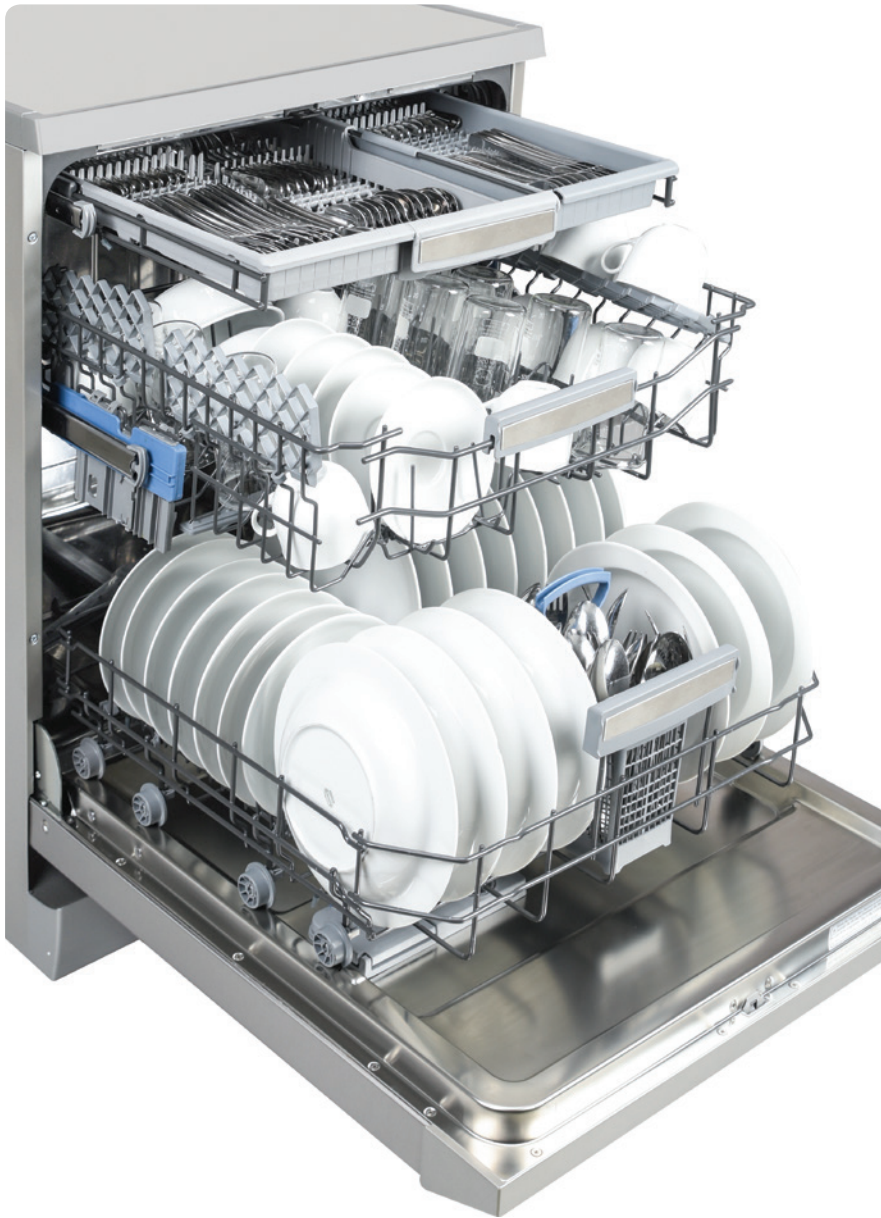

 **3<sup>rd</sup> Rack**  
*Easy Tray*

The upper cutlery basket is designed to place forks, spoons and knives, long dippers and small items. You can take out the dishes along with the 3rd rack after washing. The Upper Cutlery Basket is composed of two pieces; You can take out left or right part of the upper cutlery basket to obtain more space for the dishes in the upper basket.

\*Cutlery basket is optional

\*Up to 15 place settings





 **3<sup>rd</sup> Rack**  
*Eco Tray*

New fixed design option for 3rd rack that provides up to 15 place setting.

\*Cutlery basket is optional

## SLIDING DOOR

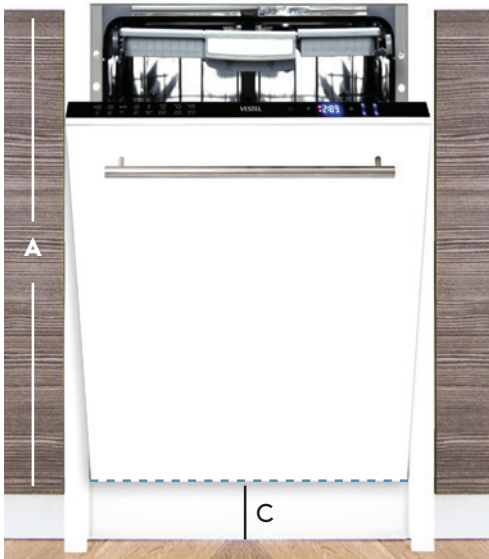

### w/o Sliding Door

Max Decorative Panel Height (A)  
717 mm

Plinth Depth (B)  
30-80 mm

Minimum Plinth Height (C)  
80 mm

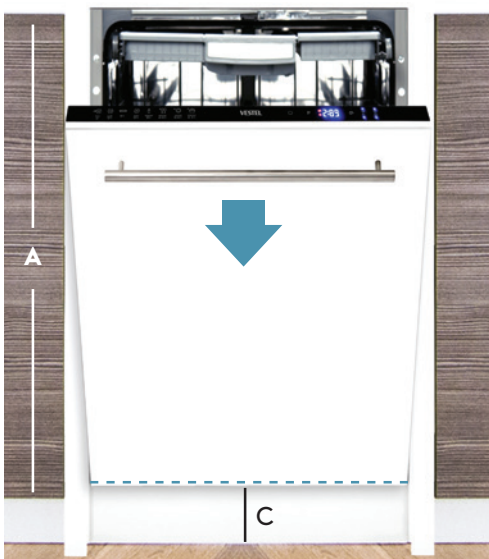

### w/ Sliding Door (Option 1)

Max Decorative Panel Height (A)  
797 mm

Plinth Depth (B)  
0-80 mm

Sliding Range  
80 mm

Minimum Plinth Height (C)  
20 mm

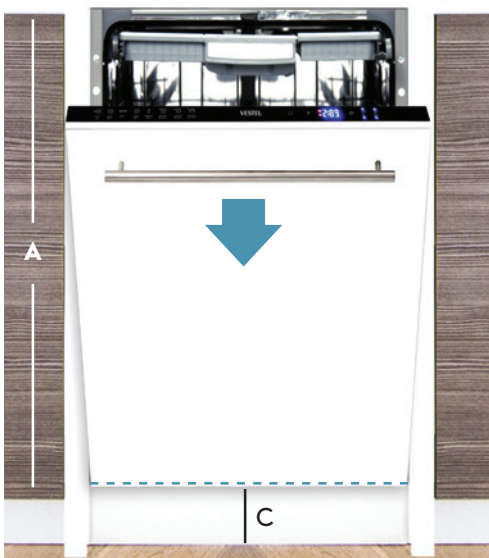

### w/ Sliding Door (Option 2)

Max Decorative Panel Height (A)  
757 mm

Plinth Depth (B)  
0-80 mm

Sliding Range  
40 mm

Minimum Plinth Height (C)  
60 mm





## MAXIMUM PLATE DIMENSIONS

### 2 Baskets



	<b>Upper Basket Position ↓</b>	<b>Upper Basket Position ↑</b>	<b>w/o height adjustment</b>
<b>Max. Plate Dimension for Upper Basket</b>	26,5 cm	21,5 cm	21,5 cm
<b>Max. Plate Dimension for Lower Basket</b>	26,5 cm	31,5 cm	31,5 cm

## 2 Baskets + 3rd Rack



	<b>Upper Basket Position ↓</b>	<b>Upper Basket Position ↑</b>	<b>w/o height adjustment</b>
<b>Max. Plate Dimension for Upper Basket</b>	19,5 cm	14,5 cm	14,5 cm
<b>Max. Plate Dimension for Lower Basket</b>	26,5 cm	31,5 cm	31,5 cm



# A4 SERIES

semi integrated



**CRYSTALIGHT**

## Energy Labeling



## Major Features



**Delay Timer**



**Half Load**



**Auto Door**



**Water Box**



**Hydro Power**



**Direct Wash**



**Triple Wash**



**3<sup>rd</sup> Rack**

*Eco/Easy/Comfort Tray*



**Interior Lighting**

*1 or 4 Spot*

See product specifications for default and optional features

## A 4 1 - 5

6/7/10 programs  
icon-LED display (full touch control)  
A++ / A+++ / A+++ -%20 energy labeling  
BLDC circulation pump  
Mini active / super active / turbo drying  
49/47/46/45/44/42/41/39 dBA (w/ BLDC)  
9 lt water consumption  
3 mode half load  
1-24 hours delay timer

### Place Setting Options

12 PS (2 baskets), 13 PS (2 baskets), 13 PS (2 baskets + 3rd rack),  
14 PS (2 baskets + 3rd rack), 15 PS (2 baskets + 3rd rack)

*\* Available for A45 only*

### Design Options

SI Daisy, Gardenya, Gardenya (Inox add-on)

### Model Versions

**A4X**



**A4X  
inox add-on**



- |            |  |
|------------|--|
| <b>A41</b> | 6 programs, BLDC.                        |
| <b>A42</b> | 7 programs, BLDC.                        |
| <b>A43</b> | 10 programs, BLDC.                       |
| <b>A44</b> | 10 programs, BLDC, Auto Door             |
| <b>A45</b> | 10 programs, BLDC, Auto Door, Water Box. |



# A 3 SERIES

semi integrated



**CRYSTALIGHT**

*Energy Labeling*



*Major Features*



**Delay Timer**



**Half Load**



**Auto Door**



**Water Box**



**Hydro Power**



**Direct Wash**



**Triple Wash**



**3<sup>rd</sup> Rack**

*Eco/Easy/Comfort Tray*



**Interior Lighting**

*1 or 4 Spot*

*See product specifications for default and optional features*

## A 3 1 - 6

6/8 programs  
icon-LED display (optional touch control)  
A++ / A+++ / A+++ -%20 energy labeling  
AC / BLDC circulation pump  
Mini active / super active / turbo drying  
57/54/52/49/47/45 dBA (w/o BLDC)  
49/47/46/45/44/42/41/39 dBA (w/ BLDC)  
9 lt water consumption  
3 mode half load  
1-24 hours delay timer

### Place Setting Options

12 PS (2 baskets), 13 PS (2 baskets), 13 PS (2 baskets + 3rd rack),  
14 PS (2 baskets + 3rd rack), 15 PS (2 baskets + 3rd rack)

\* Available for A35 only

### Design Options

SI Daisy, Gardenya, Gardenya (Inox add-on)

### Model Versions

**A3X**



**A3X  
inox add-on**



<b>A31</b>	6 programs, AC.
<b>A32</b>	8 programs, AC.
<b>A33</b>	6 programs, BLDC, Auto Door
<b>A34</b>	8 programs, BLDC, Auto Door
<b>A35</b>	8 programs, BLDC, Auto Door, Water Box.
<b>A36</b>	8 programs, BLDC.



# A 2 SERIES

semi integrated



**CRYSTALIGHT**

**Energy Labeling**



**Major Features**



**Delay Timer**



**Half Load**



**Auto Door**



**Water Box**



**Hydro Power**



**Direct Wash**



**Triple Wash**



**3<sup>rd</sup> Rack**

*Eco/Easy/Comfort Tray*



**Interior Lighting**

*1 or 4 Spot*

*See product specifications for default and optional features*

## A 2 1 - 6

6 to 8 programs  
LED display  
A++ / A+++ / A+++ -%20 energy labeling  
AC / BLDC circulation pump  
Mini active / super active / turbo drying  
57/54/52/49/47/45 dBA (w/o BLDC)  
49/47/46/45/44/42/41/39 dBA (w/ BLDC)  
9 lt water consumption  
3 mode half load  
1-24 hours delay timer

### Place Setting Options

12 PS (2 baskets), 13 PS (2 baskets), 13 PS (2 baskets + 3rd rack),  
14 PS (2 baskets + 3rd rack), 15 PS (2 baskets + 3rd rack)

\* Available for A25 only

### Design Options

SI Daisy, Gardenya, Gardenya (Inox add-on)

### Model Versions

<b>A21</b>		6 programs, AC.
<b>A22</b>		7 programs, AC.
<b>A23</b>		8 programs, AC.
<b>A24</b>		8 programs, BLDC, Auto Door.
<b>A25</b>		8 programs, BLDC, Auto Door, Water Box.
<b>A26</b>		8 programs, BLDC.
<b>inox add- on</b>		



# A1 SERIES

semi integrated



## Energy Labeling

**A<sup>+</sup>**

## Major Features



**Delay Timer**



**Half Load**



**Aqua Zone**



**3<sup>rd</sup> Rack**

*Eco/Easy/Comfort Tray*



**Interior Lighting**

*1 or 4 Spot*

See product specifications for default and optional features

## A 1 2 - 5

3 to 6 programs  
LED indicator  
A++ energy labeling  
AC circulation pump  
Mini active / super active / turbo drying  
57/54/52/49/47/45 dBA  
12 lt water consumption (9 lt with aquazone)  
1 mode half load  
3-6-9 hours delay timer

## A 1 B - E

3 to 6 programs  
LED display  
A++ energy labeling  
AC circulation pump  
Mini active / super active / turbo drying  
57/54/52/49/47/45 dBA  
12 lt water consumption (9 lt with aquazone)  
1 mode half load  
1-24 hours delay timer







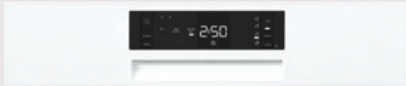

### Place Setting Options

12 PS (2 baskets), 13 PS (2 baskets), 13 PS (2 baskets + 3rd rack), 15 PS (2 baskets + 3rd rack)

### Design Options

SI Daisy, Gardenya, Gardenya (Inox add-on)

### Model Versions

	w display		w/o display
<b>A12</b>	 3 programs, AC.	<b>A1B</b>	 3 programs, AC.
<b>A13</b>	 4 programs, AC.	<b>A1C</b>	 4 programs, AC.
<b>A14</b>	 5 programs, AC.	<b>A1D</b>	 5 programs, AC.
<b>A15</b>	 6 programs, AC.	<b>A1E</b>	 6 programs, AC.
<b>inox add-on version</b>			

A Series  
**Daisy**





A Series  
**Gardenya**



*Inox cladding version for Gardenya design*

# T3 SERIES

semi integrated

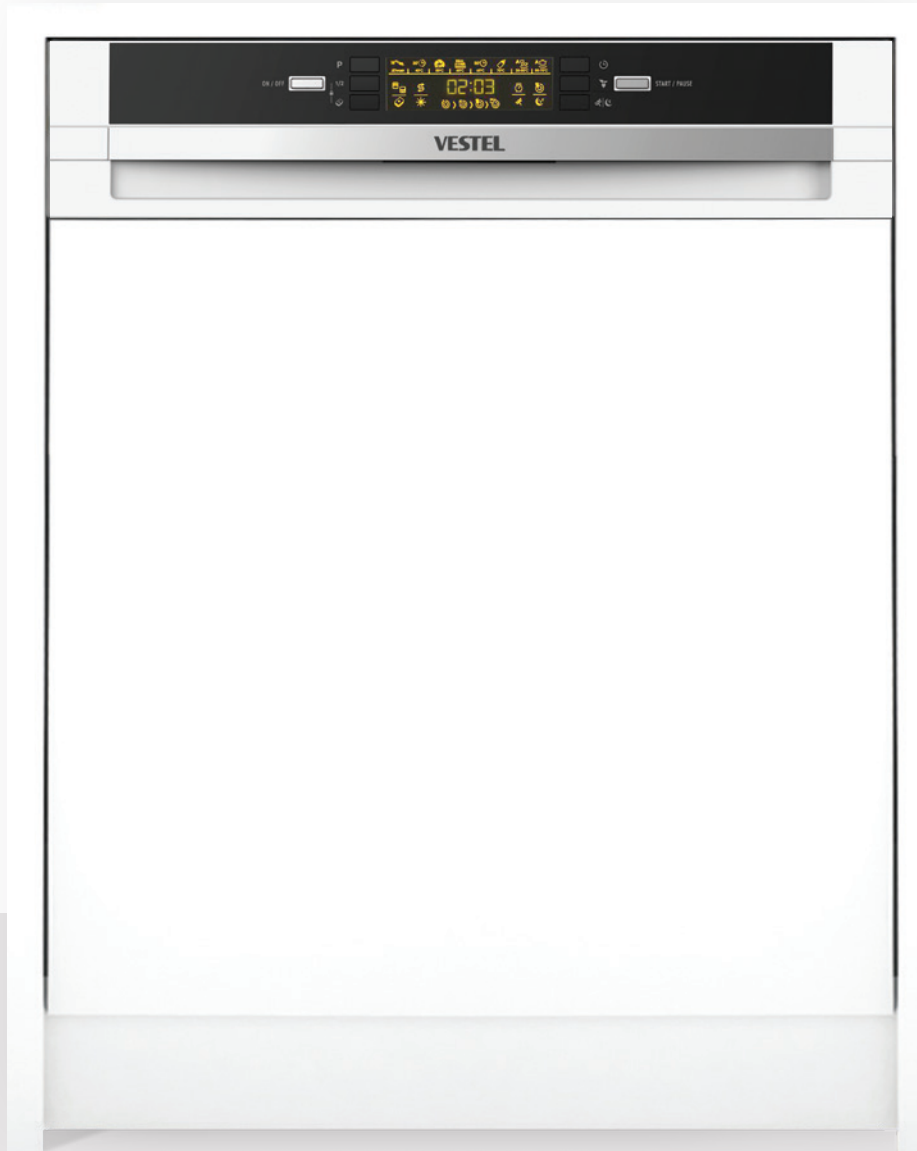

## Energy Labeling

A<sup>+++</sup> A<sup>+++</sup> A<sup>++</sup>  
-20%

## Major Features



See product specifications for default and optional features

## T 3 1 - 6

6/8 programs  
icon-LED display  
A++ / A+++ / A+++ -%20 energy labeling  
AC / BLDC circulation pump  
Mini active / super active / turbo drying  
57/54/52/49/47/45 dBA (w/o BLDC)  
49/47/46/45/44/42/41/39 dBA (w/ BLDC)  
9 lt water consumption  
3 mode half load  
1-24 hours delay timer

### Place Setting Options

12 PS (2 baskets), 13 PS (2 baskets), 13 PS (2 baskets + 3rd rack),  
14 PS (2 baskets + 3rd rack)\*, 15 PS (2 baskets + 3rd rack)

\* Available for T35 only

### Design Options

SI Ares, Patara

### Model Versions

**T3X  
Amber  
display**



**T3X  
White  
display**



- |            |  |
|------------|--|
| <b>T31</b> | 6 programs, AC.                        |
| <b>T32</b> | 8 programs, AC.                        |
| <b>T34</b> | 8 programs, BLDC, Auto Door.           |
| <b>T35</b> | 8 programs, BLDC, Auto Door Water Box. |
| <b>T36</b> | 8 programs, BLDC.                      |



T3 Series  
**Ares**



T3 Series  
**Patara**



# T 2 / 1 SERIES

semi integrated



## Energy Labeling

**A<sup>+++</sup>** **A<sup>+++</sup>** **A<sup>++</sup>**  
-20%

## Major Features



See product specifications for default and optional features



## T 11 - 3

3/4/6 programs  
LED indicator / LED display  
A++ energy labeling  
AC circulation pump  
Mini active / super active / turbo drying  
57/54/52/49/47/45 dBA (w/o BLDC)  
46/44/42/41/39 dBA (w/ BLDC)  
12 lt water consumption (9 lt with aquazone)  
1 mode half load  
1-24 hours delay timer (T11 w/o delay timer)

## T 21 - 6

8 programs  
LED display  
A+++ / A+++ -%20 energy labeling  
AC / BLDC circulation pump  
Mini active / super active / turbo drying  
57/54/52/49/47/45 dBA (w/o BLDC)  
49/47/46/45/44/42/41/39 dBA (w/ BLDC)  
9 lt water consumption  
3 mode half load  
1-24 hours delay timer

### Place Setting Options

12 PS (2 baskets), 13 PS (2 baskets), 13 PS (2 baskets + 3rd rack),  
14 PS (2 baskets + 3rd rack)\*, 15 PS (2 baskets + 3rd rack)

\* Available for T25 only

### Design Options

SI Amaranth

### Model Versions

#### T1 Series

**T11**



3 programs, AC.

**T12**



4 programs, AC.

**T13**



6 programs, AC.

#### T2 Series

**T21**



8 programs, AC.

**T24**



8 programs, BLDC, Auto Door.

**T25**



8 programs, BLDC, Auto Door, Water Box

**T26**



8 programs, BLDC.

# T3 Series **Amaranth**









# Y2 SERIES

semi integrated



## Energy Labeling

**A<sup>++</sup> A<sup>+</sup>**

## Major Features

-   
**Delay Timer**
-   
**Half Load**
-   
**Auto Door**
-   
**Water Box**
-   
**Hydro Power**
-   
**Direct Wash**
-   
**Triple Wash**

 **3<sup>rd</sup> Rack**  
Eco/Easy/Comfort Tray

 **Interior Lighting**  
1 or 4 Spot

See product specifications for default and optional features

## Y 2 1 - 6

6 to 9 programs

LED display

A++ / A+++ energy labeling

AC / BLDC circulation pump

Mini active / super active / turbo drying

57/54/52/49/47/45 dBA (w/o BLDC)

49/47/46/45/44/42/41/39 dBA (w/ BLDC)

9 lt water consumption

3 mode half load

1-19 hours delay timer







### Place Setting Options

12 PS (2 baskets), 13 PS (2 baskets), 13 PS (2 baskets + 3rd rack), 15 PS (2 baskets + 3rd rack)

### Design Options

SI Camelia Y, Silva Y, Silva Y (Inox add-on)

### Model Versions

Y21		6 programs, AC.
Y22		7 programs, AC.
Y23		8 programs, AC.
Y24		9 programs, AC.
Y25		9 programs, BLDC, Auto Door.
Y26		9 programs, BLDC.

# Y1 SERIES

semi integrated



## Energy Labeling

**A+**

## Major Features



**Delay Timer**



**Half Load**



**Aqua Zone**



**3<sup>rd</sup> Rack**

*Eco/Easy/Comfort Tray*



**Interior Lighting**

*1 or 4 Spot*

See product specifications for default and optional features



## Y 11 - 5

- 2 to 6 programs
- LED indicator
- A++ energy labeling
- AC circulation pump
- Mini active / super active / turbo drying
- 57/54/52/49/47/45 dBA
- 12 lt water consumption (9 lt with aquazone)
- 1 mode half load
- 3-6-9 hours delay timer

## Y 1 A - F

- 2 to 7 programs
- LED display
- A++ energy labeling
- AC circulation pump
- Mini active / super active / turbo drying
- 57/54/52/49/47/45 dBA
- 12 lt water consumption (9 lt with aquazone)
- 1 mode half load
- 1-19 hours delay timer

### Place Setting Options

12 PS (2 baskets), 13 PS (2 baskets), 13 PS (2 baskets + 3rd rack), 15 PS (2 baskets + 3rd rack)

### Design Options

SI Camelia Y, Silva Y, Silva Y (Inox add-on)

### Model Versions

#### w display

**Y11**



2 programs, AC.

**Y12**



3 programs, AC.

**Y13**



4 programs, AC.

**Y14**



5 programs, AC.

**Y15**



6 programs, AC.

#### w/o display

**Y1A**



2 programs, AC.

**Y1B**



3 programs, AC.

**Y1C**



4 programs, AC.

**Y1D**



5 programs, AC.

**Y1E**



6 programs, AC.

**Y1F**



7 programs, AC.

# Y Series **Silva Y**



Program Start / Pause Reset (3 sec.)

30

VESTEL

● Hygiene ● Rinse Aid ● Salt

● Rinse ● Upper Basket

● Dry ● Lower Basket

Option Delay Timer (3 sec.) Start/End (3 sec.) On/Off

- P1 - Prewash
- P2 - Clean 32-40°C
- P3 - Eco
- P4 - Daily 60°C
- P5 - Super 50-55°C
- P6 - Auto Delicate 30°C - 50°C
- P7 - Auto Normal 50°C - 60°C
- P8 - Auto Intensive 60°C - 70°C
- P9 - Steam Wash

Y Series  
**Camelia Y**





# X SERIES

semi integrated



## Energy Labeling

**A+**

## Major Features



**Delay Timer**



**Half Load**



**Aqua Zone**



**3<sup>rd</sup> Rack**

*Eco/Easy/Comfort Tray*

*See product specifications for default and optional features*

## X 11 - 6

2 to 7 programs  
LED indicator  
A++ energy labeling  
AC circulation pump  
Mini active / super active drying  
57/54/52/49/47/45 dBA  
12 lt water consumption (9 lt with aquazone)  
1 mode half load  
3-6-9 hours delay timer

## X 11 A - F

2 to 7 programs  
LED display  
A++ energy labeling  
AC circulation pump  
Mini active / super active drying  
57/54/52/49/47/45 dBA  
12 lt water consumption (9 lt with aquazone)  
1 mode half load  
1-19 hours delay timer

### Place Setting Options







12 PS (2 baskets), 13 PS (2 baskets), 13 PS (2 baskets + 3rd rack)

### Design Options

SI Camelia, Silva, Silva (Inox add-on)

### Model Versions

#### w display

<b>X11</b>	
	2 programs, AC.
<b>X12</b>	
	3 programs, AC.
<b>X13</b>	
	4 programs, AC.
<b>X14</b>	
	5 programs, AC.
<b>X15</b>	
	6 programs, AC.
<b>X16</b>	
	7 programs, AC.

#### w/o display

<b>X1A</b>	
	2 programs, AC.
<b>X1B</b>	
	3 programs, AC.
<b>X1C</b>	
	4 programs, AC.
<b>X1D</b>	
	5 programs, AC.
<b>X1E</b>	
	6 programs, AC.
<b>X1F</b>	
	7 programs, AC.

X Series  
**Camelia**





X Series  
**Silva**



# D 1 - 4 S E R I E S

semi integrated



## Energy Labeling

**A<sup>++</sup>** -20% **A<sup>++</sup>** **A<sup>+</sup>**



Sliding Door

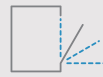

Self Balance

## Major Features



Delay Timer



Half Load



Auto Door



Water Box



Hydro Power



Direct Wash



Triple Wash



Aqua Zone

**infoLED**



3<sup>rd</sup> Rack

Eco/Easy/Comfort Tray



Interior Lighting

1 or 4 Spot

See product specifications for default and optional features

## D 13 - D 21 - Z 21 - D 22

4 to 6 programs  
LED indicator / LED display  
A++ energy labeling  
AC circulation pump  
Mini active / super active / turbo drying  
57/54/52/49/47/45 dBA  
12 lt water consumption (9 lt with aquazone)  
1 mode half load for Z21  
3-6-9 hours delay timer (D13 w/o delay timer)

## D 41 - 6

9 programs  
LED display  
A++ / A+++ / A+++ -%20 energy labeling  
AC / BLDC circulation pump  
Mini active / super active / turbo drying  
57/54/52/49/47/45 dBA (w/o BLDC)  
49/47/46/45/44/42/41/39 dBA (w/ BLDC)  
9 lt water consumption  
3 mode half load  
1-19 hours delay timer

### Place Setting Options

12 PS (2 baskets), 13 PS (2 baskets), 13 PS (2 baskets + 3rd rack),  
14 PS (2 baskets + 3rd rack)\*, 15 PS (2 baskets + 3rd rack)

\* Available for D45 only

### Design Options

Astrum, Rhea, Rhea (Inox Cladding, Inox Half Cladding, Inox add-on)

### Model Versions

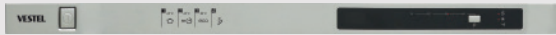
**D13**  **D13**  
4 programs, AC.

**D41**  **D41**  
9 programs, AC.

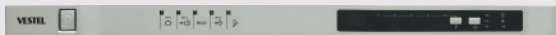
**D21**  **D21**  
5 programs, AC.

**D43**  **D43**  
9 programs, BLDC and Auto Door.

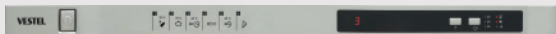
**D22**  **D22**  
6 programs, AC.

**D45**  **D45**  
9 programs, BLDC, Auto Door and Water Box.

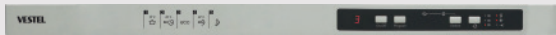
**Z21**  **Z21**  
5 programs, AC.

**D46**  **D46**  
9 programs, BLDC.



D Series  
**Astrum**



D Series  
**Rhea**



# D 5 SERIES

semi integrated



## Energy Labeling

**A<sup>++</sup>** -20% **A<sup>++</sup>** **A<sup>+</sup>**



Sliding Door



Self Balance

## Major Features



Delay Timer



Half Load



Auto Door



Water Box



Hydro Power



Direct Wash



Triple Wash



Aqua Zone

**infoLED**



3<sup>rd</sup> Rack

Eco/Easy/Comfort Tray



Interior Lighting

1 or 4 Spot

See product specifications for default and optional features



## D 51 - 5

6/8/9 programs

LED display

A++ / A+++ / A+++ -%20 energy labeling

AC / BLDC circulation pump

Mini active / super active / turbo drying

57/54/52/49/47/45 dBA (w/o BLDC)

49/47/46/45/44/42/41/39 dBA (w/ BLDC)

9 lt water consumption (D51: 12 lt (9 lt with aquazone))

3 mode half load (1 mode for D51)

1-19 hours delay timer

### Place Setting Options

12 PS (2 baskets), 13 PS (2 baskets), 13 PS (2 baskets + 3rd rack),

14 PS (2 baskets + 3rd rack)\*, 15 PS (2 baskets + 3rd rack)

\* Available for D55 only

### Design Options

Astrum, Rhea, Rhea (Inox Cladding, Inox Half Cladding, Inox add-on)

## Model Versions

### Black control panel



**D51**

6 programs, AC.



**D52**

8 programs, AC.



**D53**

8 programs, BLDC and Auto Door

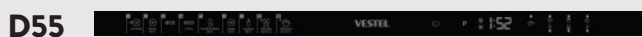

**D55**

9 programs, BLDC, Auto Door and Water Box.



**D56**

9 programs, BLDC.

### Inox look control panel



6 programs, AC.



8 programs, AC.



8 programs, BLDC and Auto Door

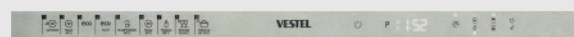

9 programs, BLDC, Auto Door and Water Box.



9 programs, BLDC.

# TALL-TUB INTEGRATED RANGE



## Energy Labeling



## Color Options



Painted

Stainless steel

## Major Features



Delay Timer



Half Load



Hydro Power

## Dimensions

Height (inch, mm) 33 7/8" ; 861 mm

Width (inch, mm) 23 9/16" ; 598 mm

Depth (inch, mm) 22 1/2" ; 570 mm



3<sup>rd</sup> Rack

Eco/Easy/Comfort Tray

See product specifications for default and optional features

## Z A 5 - Z B 7

Tall-tub structure

6 or 8 programs

LED display

Energy Star

AC/BLDC circulation pump

Mini active / super active / turbo drying

57/55/53/51 dBA (w/o BLDC)

49/47/45/44 dBA (w/ BLDC)

≤ 3,5 gal water consumption

1 or 3 mode half load

1-19 hours delay timer

### Place Setting Options

12 PS (2 baskets) 13 PS (2 baskets), 15 PS (2 baskets + 3rd rack)

### Design Options

Rhea, Astrum

### Model Versions

#### Astrum



#### Rhea





# Tall-tub Integrated Range

## *Rhea*



Tall-tub Integrated Range

**Astrum**



# STANDARD TUB

## Semi-Integrated

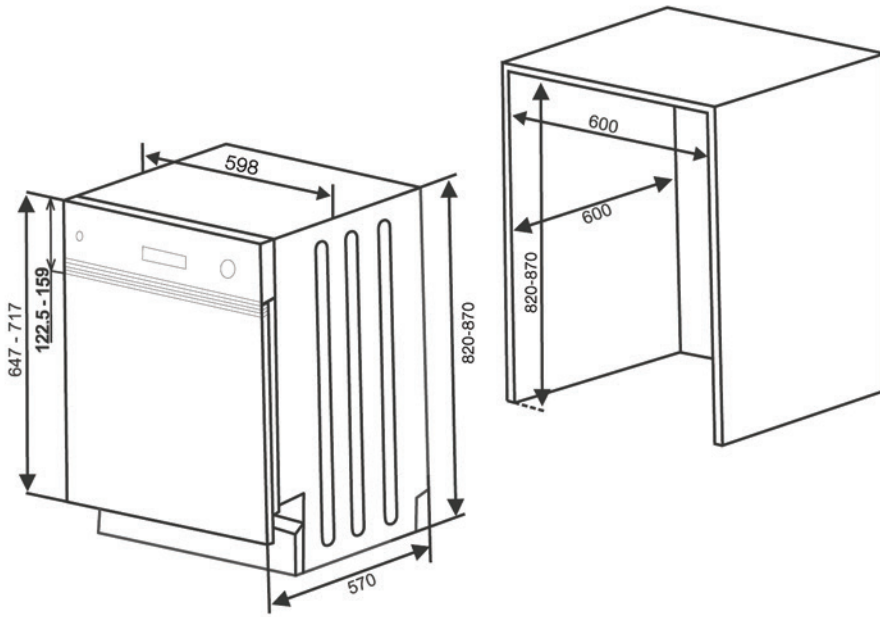

## Integrated

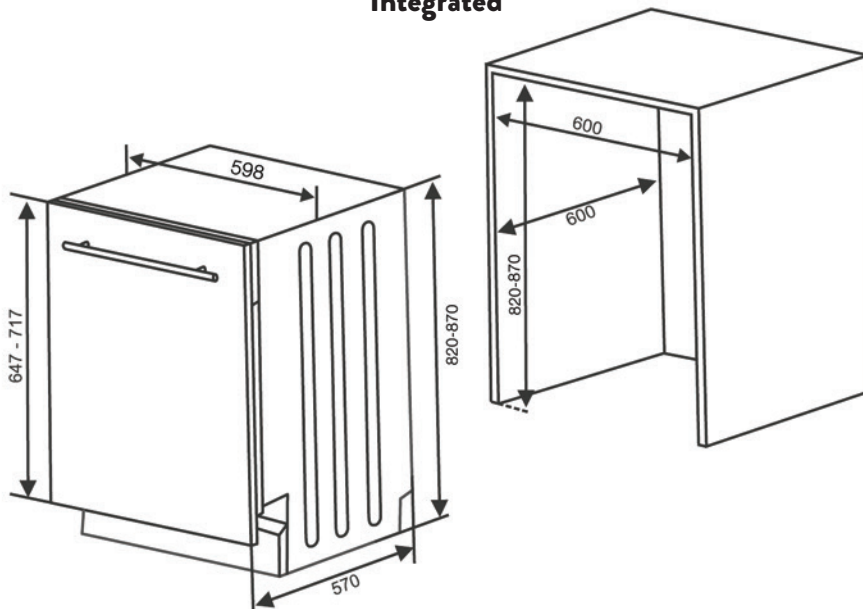



## TALL TUB

### Full Door

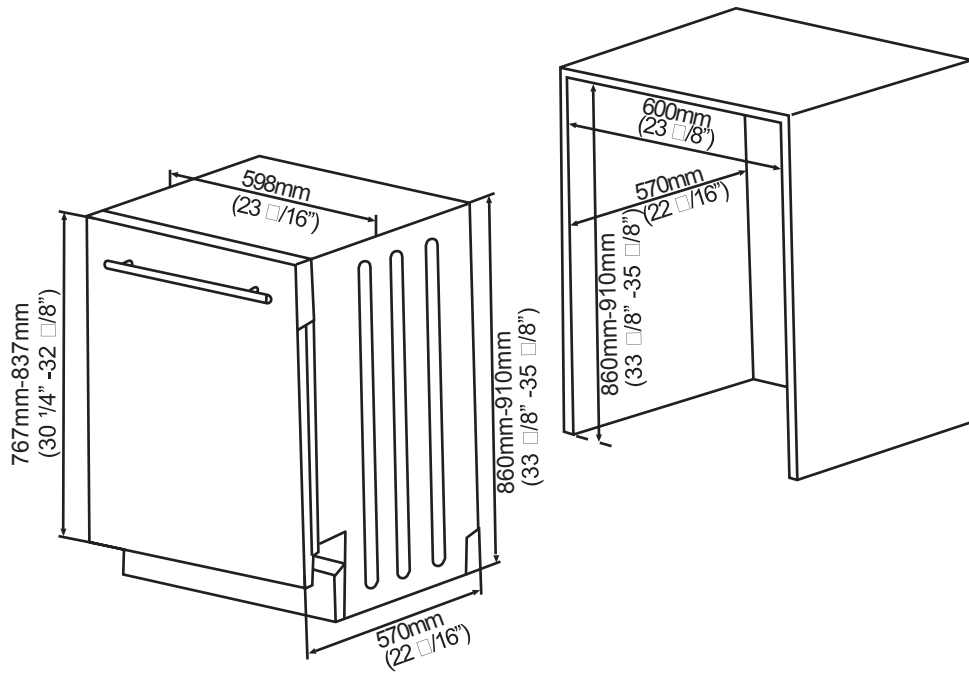

### Integrated

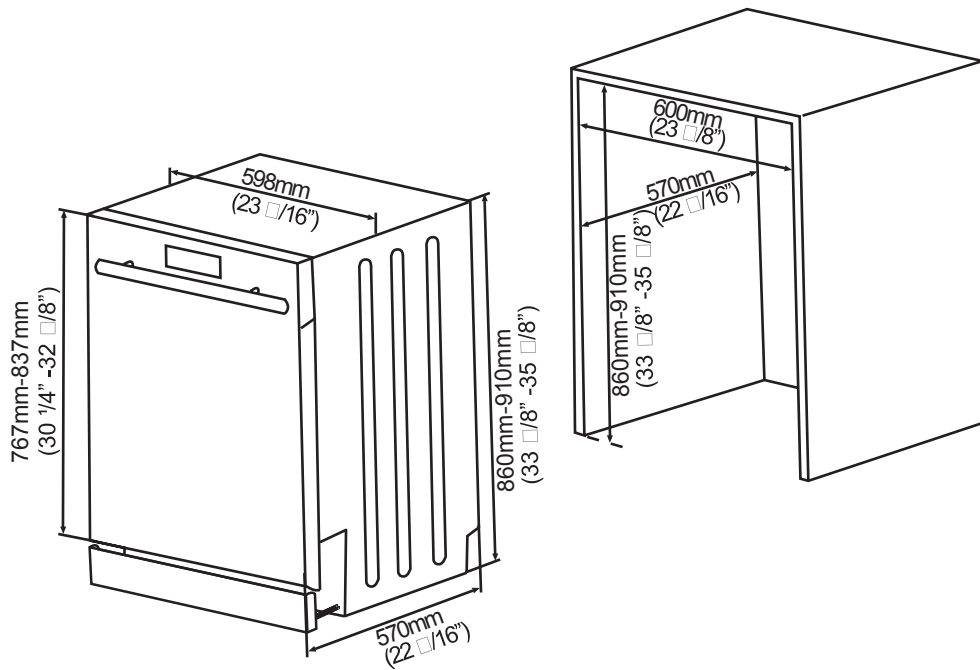

## **45 cm Dishwashers**

*Semi-integrated & Integrated Ranges*







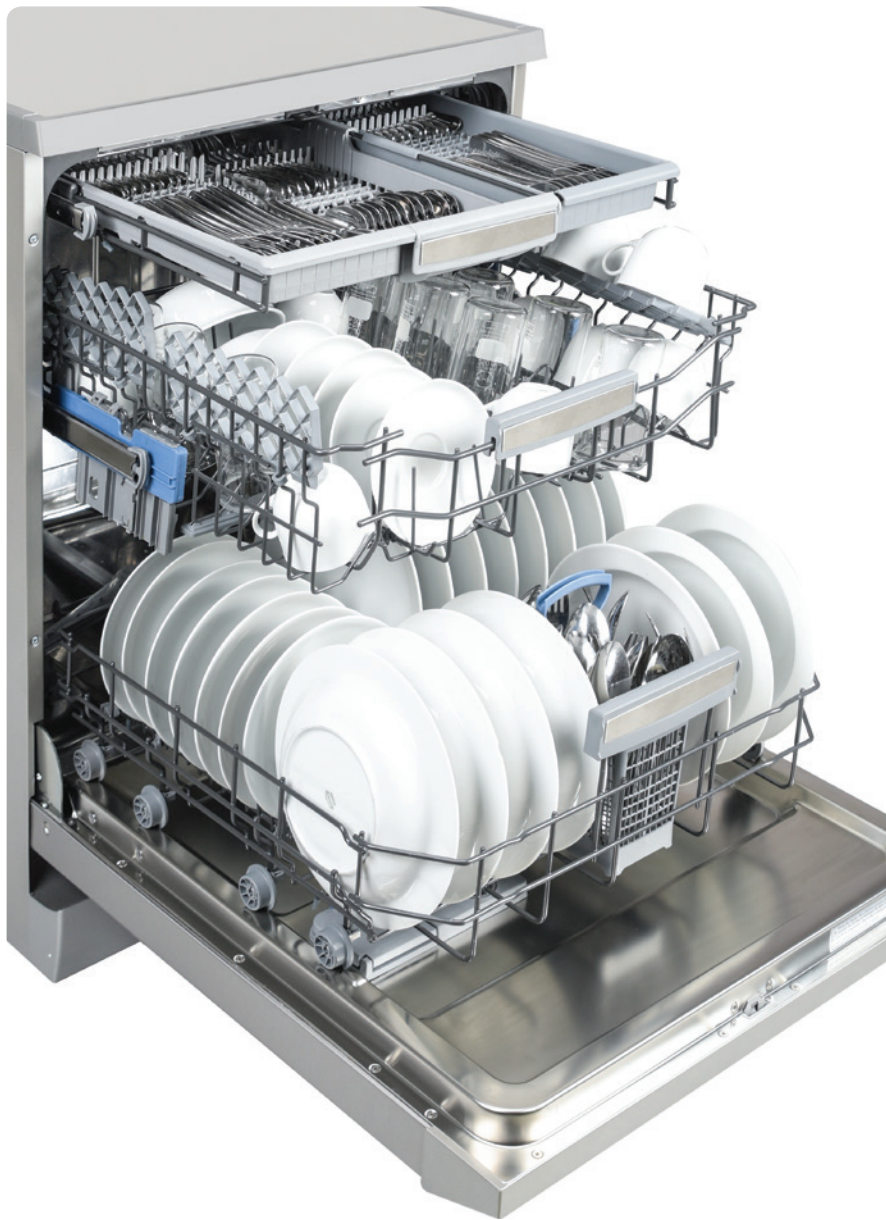

 **3<sup>rd</sup> Rack**  
*Easy Tray*

The upper cutlery basket is designed to place forks, spoons and knives, long dippers and small items. You can take out the dishes along with the 3rd rack after washing. The Upper Cutlery Basket is composed of two pieces; You can take out left or right part of the upper cutlery basket to obtain more space for the dishes in the upper basket.

\*Cutlery basket is optional

\*Up to 15 place settings

## FEATURES

### Maximum Plate Diameter



### Lower Basket - 10 Place Settings



### Standard Cutlery Basket



### Adjustable Basket

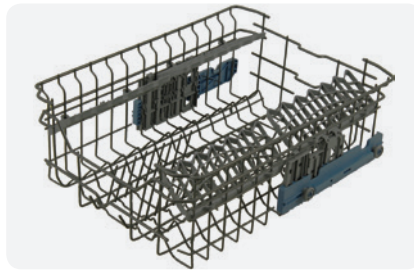

Adjustable only when loaded

### Adjustable Upper Basket



Adjustable only when empty

## Inox Look Control Panels

60 & 45 cm D5X series (FI)

Versions: D51, D52, D53, D55

Dead front display & full touch control



## MAXIMUM PLATE DIMENSIONS

### 2 Baskets



	<b>Upper Basket Position ↓</b>	<b>Upper Basket Position ↑</b>	<b>w/o height adjustment</b>
<b>Max. Plate Dimension for Upper Basket</b>	26,5 cm	21,5 cm	21,5 cm
<b>Max. Plate Dimension for Lower Basket</b>	25,5 cm	30,5 cm	30,5 cm



## 2 Baskets + 3rd Rack



	<b>Upper Basket Position ↓</b>	<b>Upper Basket Position ↑</b>	<b>w/o height adjustment</b>
<b>Max. Plate Dimension for Upper Basket</b>	19,5 cm	14,5 cm	14,5 cm
<b>Max. Plate Dimension for Lower Basket</b>	25,5 cm	30,5 cm	30,5 cm

# A 4 SERIES

integrated

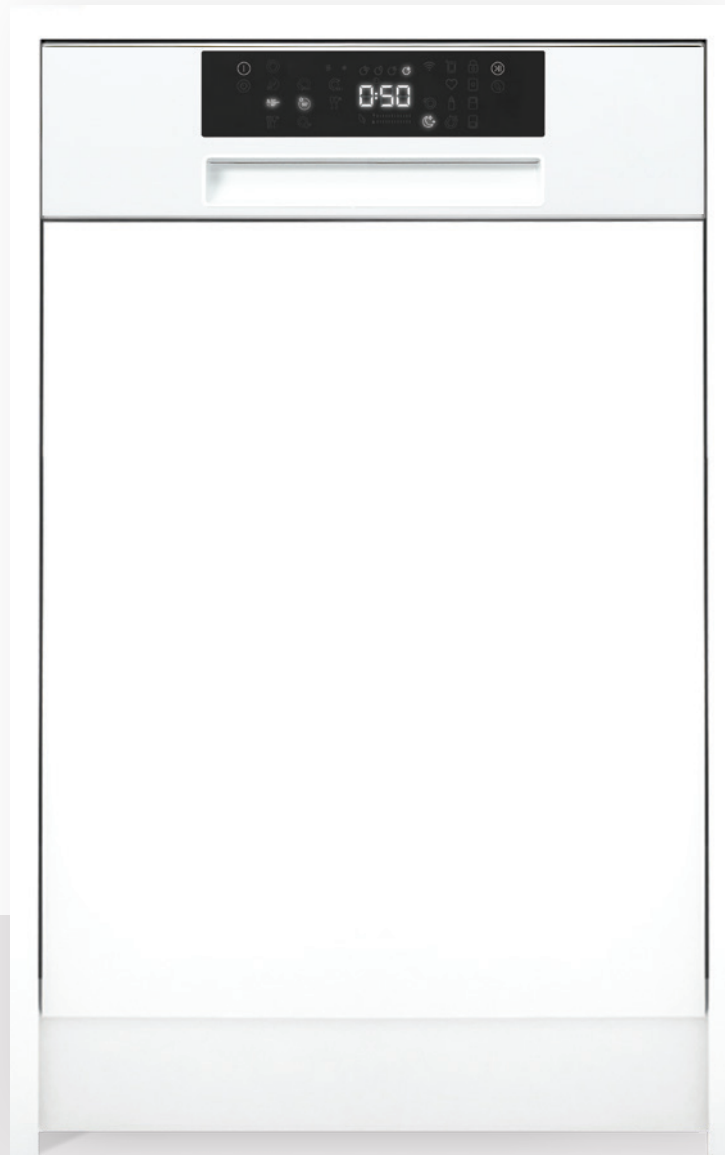

## Energy Labeling



## Major Features

-  **Delay Timer**
-  **Half Load**
-  **Auto Door**
-  **Hydro Power**

-  **3<sup>rd</sup> Rack**  
Easy Tray
-  **Interior Lighting**  
1 or 4 Spot

See product specifications for default and optional features

## A 4 1 - 5

6/7/10 programs  
icon-LED display (full touch control)  
A++ / A+++ energy labeling  
BLDC circulation pump  
Turbo drying  
44 dBA  
9 lt water consumption  
3 mode half load  
1-24 hours delay timer

### Place Setting Options

10 PS (2 baskets), 10 PS (2 baskets + 3rd rack)

### Design Options

SI Gardenya, Gardenya (Inox add-on), Gardenya (Inox cladding)

### Model Versions

**A4X**



**A4X  
inox  
add-on**



- A41** 6 programs, BLDC.
- A42** 7 programs, BLDC.
- A43** 10 programs, BLDC, Auto Door.
- A44** 10 programs, BLDC, Auto Door.



# A 3 SERIES

integrated

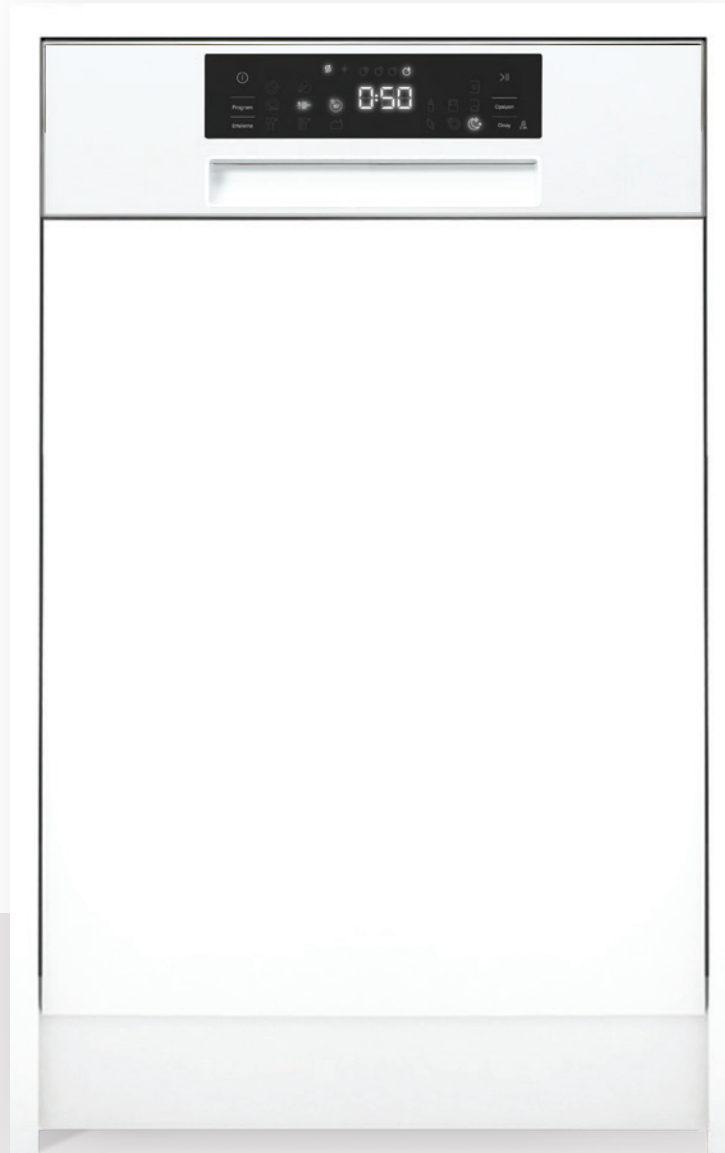

## Energy Labeling

**A++** **A+**

## Major Features



**Delay Timer**



**Half Load**



**Auto Door**



**Hydro Power**



**3<sup>rd</sup> Rack**  
Easy Tray



**Interior Lighting**  
1 or 4 Spot

See product specifications for default and optional features

## A 3 1 - 3 6

6/8 programs  
icon-LED display (optional touch control)  
A++ / A+++ energy labeling  
AC / BLDC circulation pump  
Mini active / super active / turbo drying  
57/54/52/49/47/45 dBA (w/o BLDC)  
44 dBA (w/ BLDC)  
9 lt water consumption  
3 mode half load  
1-24 hours delay timer

### Place Setting Options

10 PS (2 baskets), 10 PS (2 baskets + 3rd rack)

### Design Options

SI Gardenya, Gardenya (Inox add-on), Gardenya (Inox cladding)

### Model Versions

**A3X**



**A3X  
inox  
add-on**



**A31**

6 programs, AC.

**A32**

8 programs, AC.

**A33**

6 programs, BLDC, Auto Door.

**A34**

8 programs, BLDC, Auto Door.

# A 2 SERIES

integrated

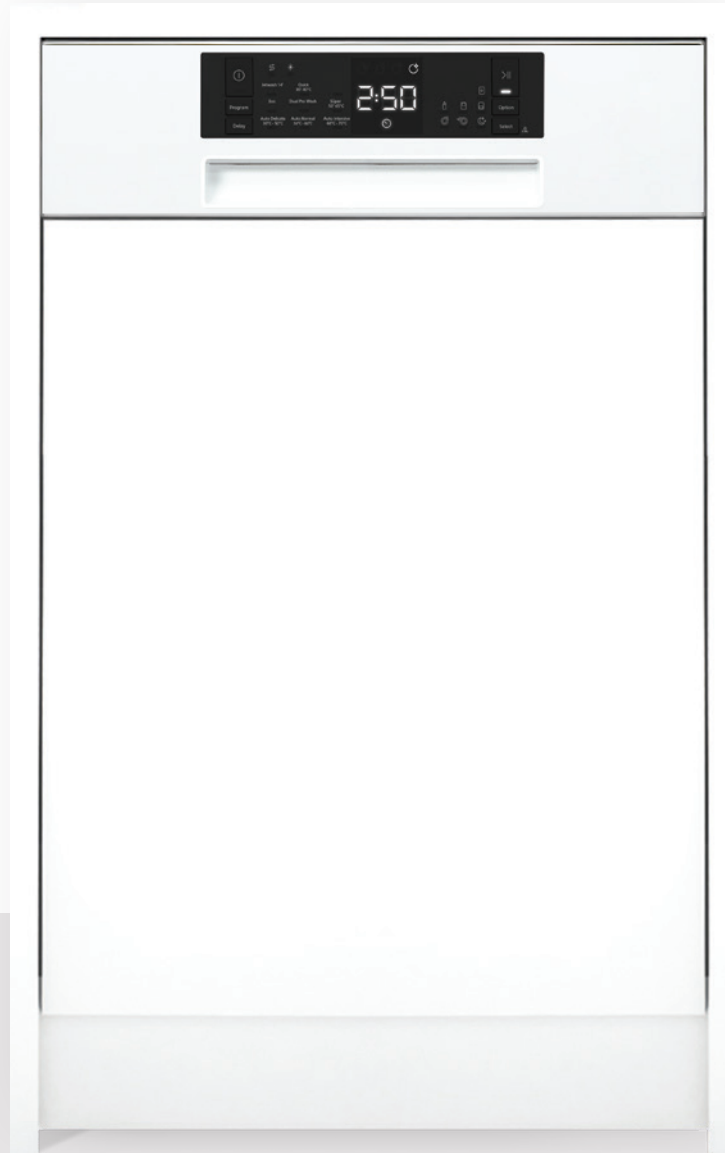

## Energy Labeling



## Major Features



Delay Timer



Half Load



Auto Door



Hydro Power



3<sup>rd</sup> Rack  
Easy Tray



Interior Lighting  
1 or 4 Spot

See product specifications for default and optional features



## A 21 - 4

6 to 8 programs  
LED display  
A++ / A+++ energy labeling  
AC / BLDC circulation pump  
Mini active / super active / turbo drying  
57/54/52/49/47/45 dBA (w/o BLDC)  
44 dBA (w/ BLDC)  
9 lt water consumption  
3 mode half load  
1-24 hours delay timer

### Place Setting Options

10 PS (2 baskets), 10 PS (2 baskets + 3rd rack)

### Design Options

SI Gardenya, Gardenya (Inox add-on), Gardenya (Inox cladding)

### Model Versions

**A21**



6 programs, AC.

**A22**



7 programs, AC.

**A23**



8 programs, AC.

**A24**



8 programs, BLDC, Auto Door.

**A24  
inox  
add-on**



# A1 SERIES

integrated

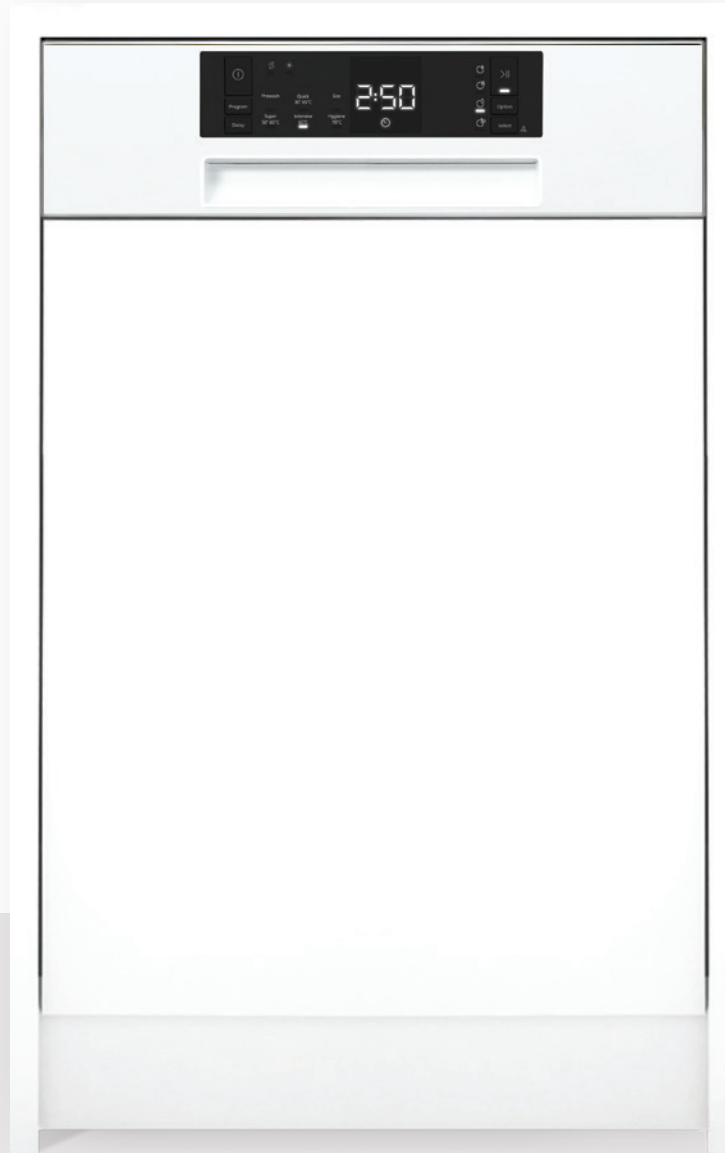

## Energy Labeling

**A+**

## Color Options



Painted

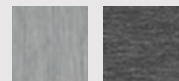

Stainless steel

## Major Features



Delay Timer



Half Load



Aqua Zone

See product specifications for default and optional features

## A 1 2 - 5

3 to 6 programs  
LED indicator  
A++ energy labeling  
AC circulation pump  
Mini active / super active  
57/54/52/49/47/45 dBA  
11 lt water consumption (9 lt with aquazone)  
1 mode half load  
3-6-9 hours delay timer

## A 1 B - E

3 to 6 programs  
LED display  
A++ energy labeling  
AC circulation pump  
Mini active / super active  
57/54/52/49/47/45 dBA  
11 lt water consumption (9 lt with aquazone)  
1 mode half load  
1-24 hours delay timer

### Place Setting Options

10 PS (2 baskets)

### Design Options

SI Gardenya, Gardenya (Inox add-on), Gardenya (Inox cladding)

### Model Versions

**A12**



3 programs, AC.

**A13**



4 programs, AC.

**A14**



5 programs, AC.

**A15**



6 programs, AC.

**inox  
add-on  
version**



**A1B**



3 programs, AC.

**A1C**



4 programs, AC.

**A1D**



5 programs, AC.

**A1E**



6 programs, AC.





# T 2 / 1 SERIES

integrated

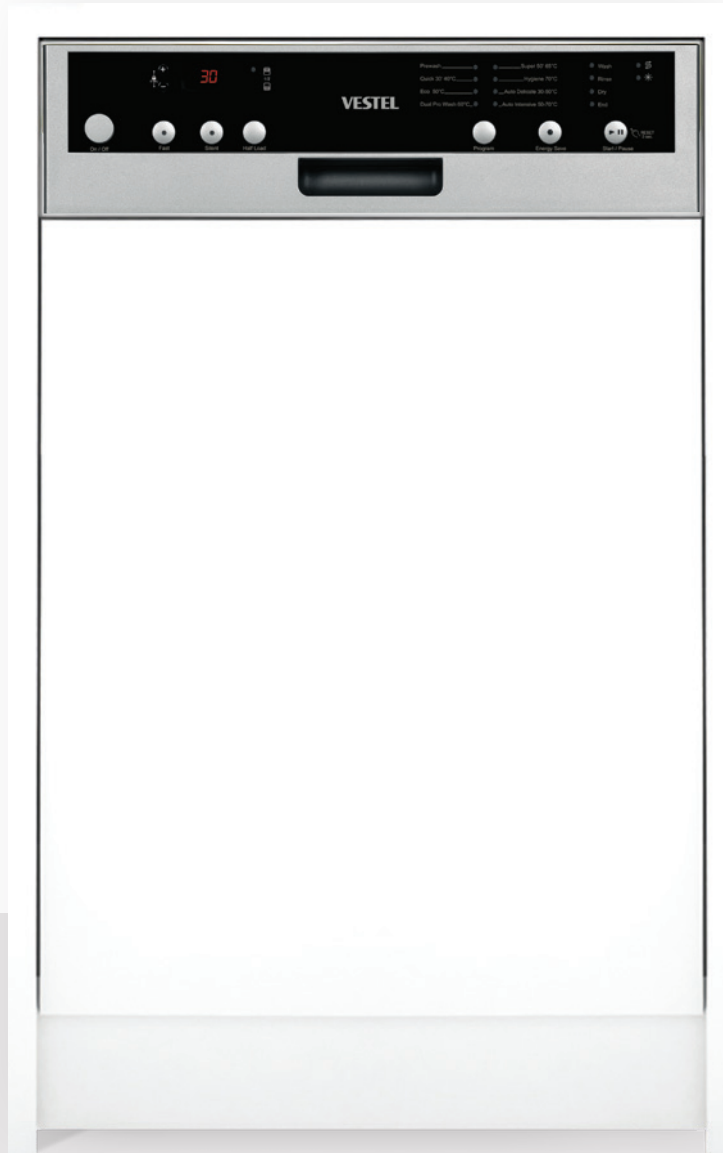

## Energy Labeling



## Major Features



See product specifications for default and optional features

## T 1 4 - 5

7 programs  
LED indicator / LED display  
A++ energy labeling  
AC circulation pump  
Mini active / super active / turbo drying  
57/54/52/49/47/45 dBA  
11 lt water consumption (9 lt with aquazone)  
1 mode half load (T15 w/o half load)  
1-24 hours delay timer (3-6-9 hours for T15)

## T 2 1 - 4

8 programs  
LED display  
A++ / A+++ energy labeling  
AC / BLDC circulation pump  
Mini active / super active / turbo drying  
57/54/52/49/47/45 dBA (w/o BLDC)  
44 dBA (w/ BLDC)  
9 lt water consumption  
3 mode half load  
1-24 hours delay timer

### Place Setting Options

10 PS (2 baskets), 10 PS (2 baskets + 3rd rack)

### Design Options

SI Vento

### Model Versions

T14



7 programs, AC.

T21



8 programs, AC.

T15



7 programs, AC.

T22



8 programs, AC.

T24



8 programs, BLDC, Auto Door.

# Y2 SERIES

integrated

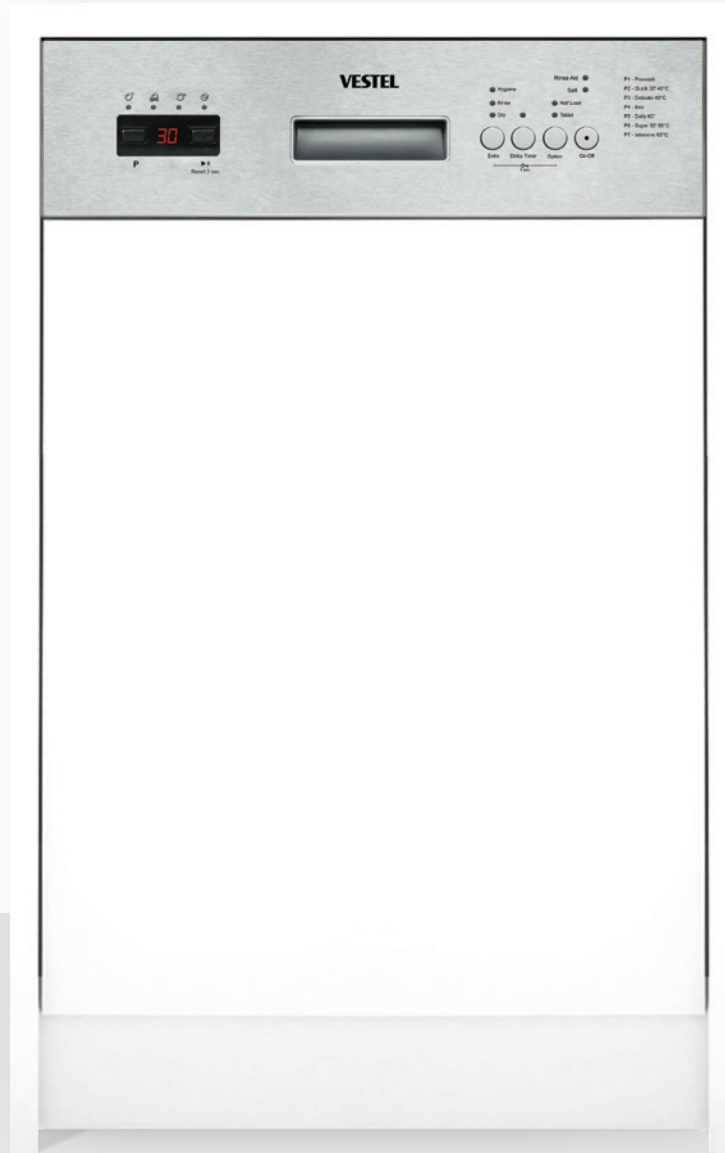

## Energy Labeling



## Major Features

-   
**Delay Timer**
-   
**Half Load**
-   
**Auto Door**
-   
**Hydro Power**

-   
**3<sup>rd</sup> Rack**  
*Easy Tray*
-   
**Interior Lighting**  
*1 or 4 Spot*

See product specifications for default and optional features



## Y 21 - 5

6 to 9 programs

LED display

A++ / A+++ energy labeling

AC / BLDC circulation pump

Mini active / super active / turbo drying

57/54/52/49/47/45 dBA (w/o BLDC)

44 dBA (w/ BLDC)

9 lt water consumption

3 mode half load

1-19 hours delay timer

### Place Setting Options

10 PS (2 baskets), 10 PS (2 baskets + 3rd rack)

### Design Options

SI Camelia Y, Klikya Y, Lydia Y, Silva Y, Silva Y (Inox add-on)

### Model Versions

Y21



6 programs, AC.

Y22



7 programs, AC.

Y23



8 programs, AC.

Y24



9 programs, AC.

Y25



9 programs, BLDC, Auto Door.

# Y1 SERIES

integrated

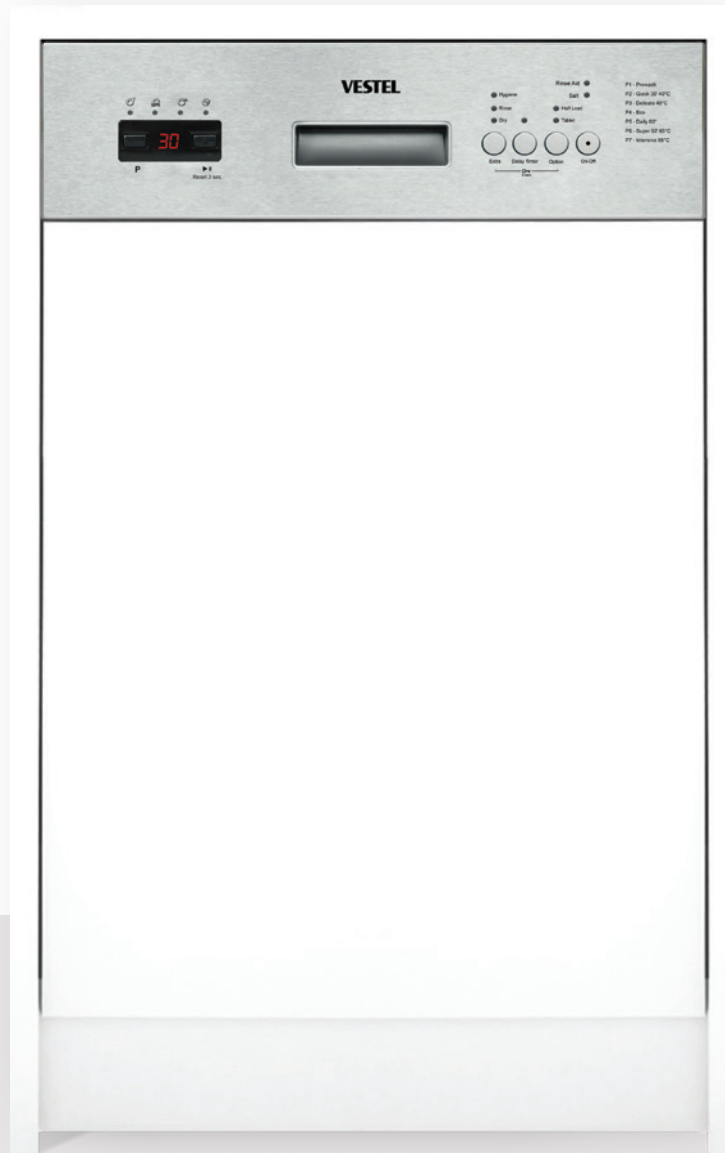

## Energy Labeling

**A+**

## Major Features



**Delay Timer**



**Half Load**



**Auto Door**



**Hydro Power**



**3<sup>rd</sup> Rack**  
Easy Tray



**Interior Lighting**  
1 or 4 Spot

See product specifications for default and optional features

## Y 11 - 5

2 to 6 programs  
LED indicator  
A++ energy labeling  
AC circulation pump  
Mini active / super active / turbo drying  
57/54/52/49/47/45 dBA  
11 lt water consumption (9 lt with aquazone)  
1 mode half load  
3-6-9 hours delay timer

## Y 1 A - F

2 to 7 programs  
LED display  
A++ energy labeling  
AC circulation pump  
Mini active / super active / turbo drying  
57/54/52/49/47/45 dBA  
11 lt water consumption (9 lt with aquazone)  
1 mode half load  
1-19 hours delay timer

### Place Setting Options

10 PS (2 baskets), 10 PS (2 baskets + 3rd rack)

### Design Options

SI Camelia Y, Klikya Y, Lydia Y, Silva Y, Silva Y (Inox add-on)

### Model Versions

#### w/o display

Y11



2 programs, AC.

Y12



3 programs, AC.

Y13



4 programs, AC.

Y14



5 programs, AC.

Y15



6 programs, AC.

#### w display

Y1A



2 programs, AC.

Y1B



3 programs, AC.

Y1C



4 programs, AC.

Y1D



5 programs, AC.

Y1E



6 programs, AC.

Y1F



7 programs, AC.



Y Series  
**Silva**



Y Series  
**Lydia**



Y Series  
**Camelia**





Y Series  
**Klikya**



# X SERIES

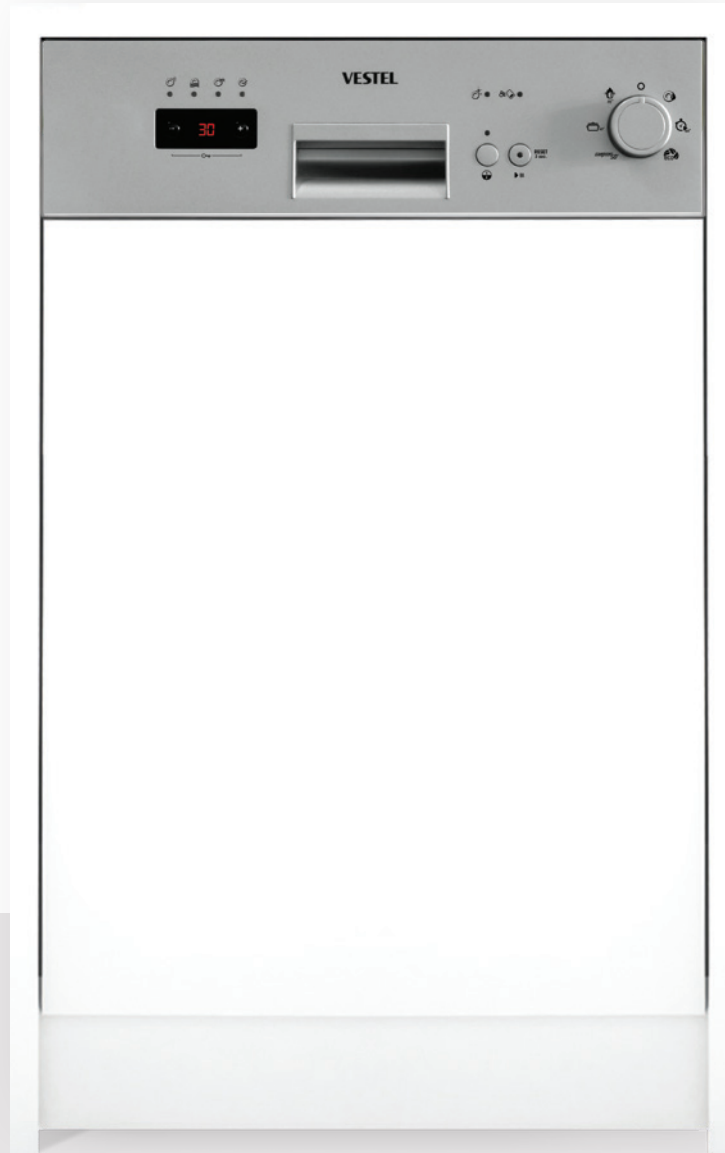

## Energy Labeling

**A<sup>+</sup>**

## Major Features



**Delay Timer**



**Half Load**



**Aqua Zone**

*See product specifications for default and optional features*

## X 11 - 6

2 to 7 programs  
LED indicator  
A++ energy labeling  
AC circulation pump  
Mini active / super active drying  
57/54/52/49/47/45 dBA  
11 lt water consumption (9 lt with aquazone)  
1 mode half load  
3-6-9 hours delay timer

## X 1 A - F

2 to 7 programs  
LED display  
A++ energy labeling  
AC circulation pump  
Mini active / super active drying  
57/54/52/49/47/45 dBA  
11 lt water consumption (9 lt with aquazone)  
1 mode half load  
1-19 hours delay timer

### Place Setting Options

10 PS (2 baskets)

### Design Options

SI Klikya, Orchis

### Model Versions

#### w/o display

**X11**

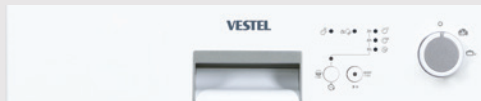

2 programs, AC.

**X12**



3 programs, AC.

**X13**



4 programs, AC.

**X14**



5 programs, AC.

**X15**



6 programs, AC.

**X16**



7 programs, AC.

#### w display

**X1A**

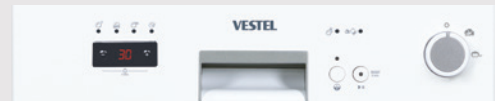

2 programs, AC.

**X1B**

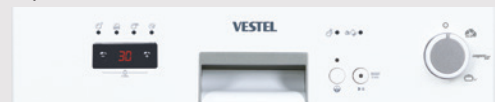

3 programs, AC.

**X1C**



4 programs, AC.

**X1D**

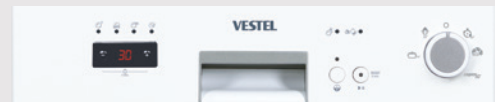

5 programs, AC.

**X1E**

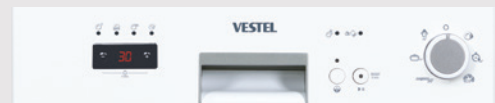

6 programs, AC.

**X1F**

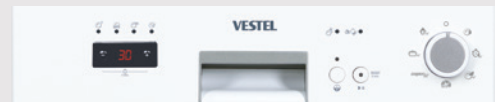

7 programs, AC.



X Series  
**Orchis**



X Series  
**Klikya**



# D 1 - 4 S E R I E S

integrated



## Energy Labeling

**A+**



Sliding Door



Self Balance

## Major Features



Delay Timer



Half Load



Aqua Zone

**infoLED**



3<sup>rd</sup> Rack  
Easy Tray

See product specifications for default and optional features



## D 12 - D 21 - Z 21 - D 22 - D 32

3/5/6/8 programs  
LED indicator / LED display  
A++ energy labeling  
AC circulation pump  
Mini active / super active / turbo drying  
57/54/52/49/47/45 dBA  
11 lt water consumption (9 lt with aquazone)  
1 mode half load (D12 w/o half load)  
3-6-9 or 1-19 hours delay timer  
(D12 w/o delay timer)

## D 41 - 2

8 programs  
LED display  
A++ energy labeling  
AC circulation pump  
Mini active / super active / turbo drying  
57/54/52/49/47/45 dBA  
9 lt water consumption  
3 mode half load  
1-19 hours delay timer

### Place Setting Options

10 PS (2 baskets), 10 PS (2 baskets + 3rd rack)

### Design Options

Alinda, Spero, Spero (Inox Cladding, Inox Half Cladding, Inox add-on)

### Model Versions



**D12**

3 programs, AC.



**D41**

8 programs, AC.



**D21**

5 programs, AC.



**D42**

8 programs, AC.



**D22**

6 programs, AC.



**D32**

8 programs, AC.



**Z21**

5 programs, AC.

D Series  
**Spero**



D Series  
**Alinda**





# D 5 SERIES

integrated



## Energy Labeling

**A++ A+**



Sliding Door



Self Balance

## Major Features



Delay Timer



Half Load



Auto Door



Hydro Power



Aqua Zone



3<sup>rd</sup> Rack  
Easy Tray



Interior Lighting  
1 or 4 Spot

See product specifications for default and optional features

## D 51 - 3

6/8 programs

LED display

A++ / A+++ energy labeling

AC / BLDC circulation pump

Mini active / super active / turbo drying

57/54/52/49/47/45 dBA (w/o BLDC)

44 (w/ BLDC)

9 lt water consumption (D51: 12 lt (9 lt with aquazone))

3 mode half load (1 mode for D51)

1-19 hours delay timer

### Place Setting Options

10 PS (2 baskets), 10 PS (2 baskets + 3rd rack)

### Design Options

Hemen, Hemen (Inox look)

### Model Versions

#### Black control panel

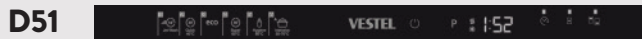

**D51**

6 programs, AC.



**D52**

8 programs, AC.



**D53**

8 programs, BLDC and Auto Door

#### Inox look control panel

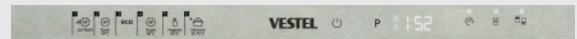

6 programs, AC.

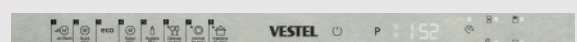

8 programs, AC.

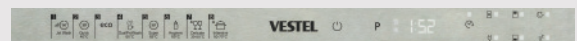

8 programs, BLDC and Auto Door

# TALL-TUB INTEGRATED RANGE



## Energy Labeling



## Color Options



Painted

Stainless steel

## Major Features



Delay Timer



Half Load



Hydro Power

## Dimensions

Height (inch, mm)

32 1/4" ; 820 mm

Width (inch, mm)

17 27/32" ; 450 mm

Depth (inch, mm)

22 1/2" ; 570 mm



3<sup>rd</sup> Rack  
Easy Tray

See product specifications for default and optional features



## Z A 5 - Z B 7

Standard-tub structure

6 or 8 programs

LED display

Energy Star

AC/BLDC circulation pump

Mini active / super active / turbo drying

57/55/53/51 dBA (w/o BLDC)

49/47/45/44 dBA (w/ BLDC)

≤ 3,5 gal water consumption

1 or 3 mode half load

1-19 hours delay timer

### Place Setting Options

10 PS (2 baskets), 10 PS (2 baskets + 3rd rack)

### Design Options

Spero

### Model Versions

**ZBA5**



6 programs, AC or BLDC.

**ZBA7**



8 programs, AC or BLDC.

# Tall-tub Integrated Range **Spero**









# STANDARD TUB

## Semi-Integrated

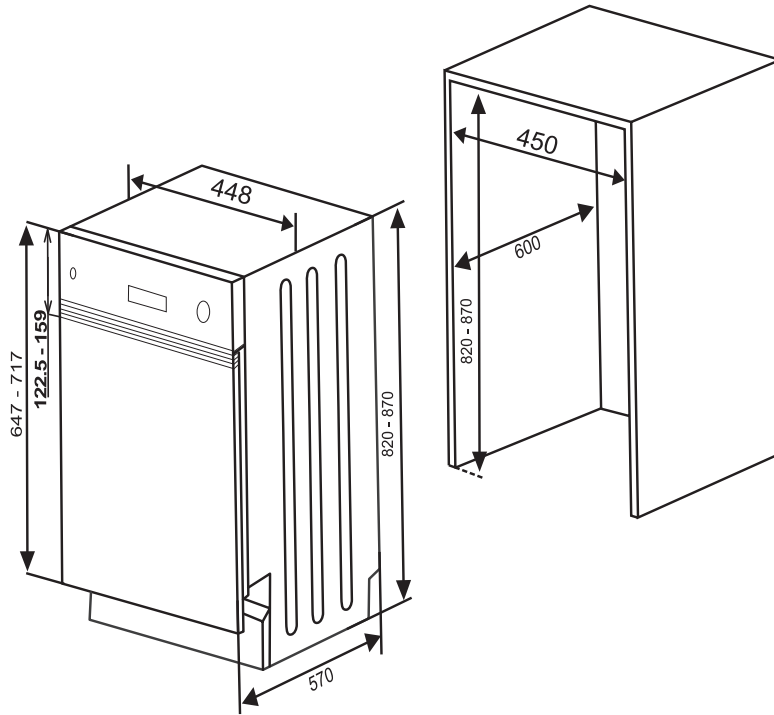

## Integrated

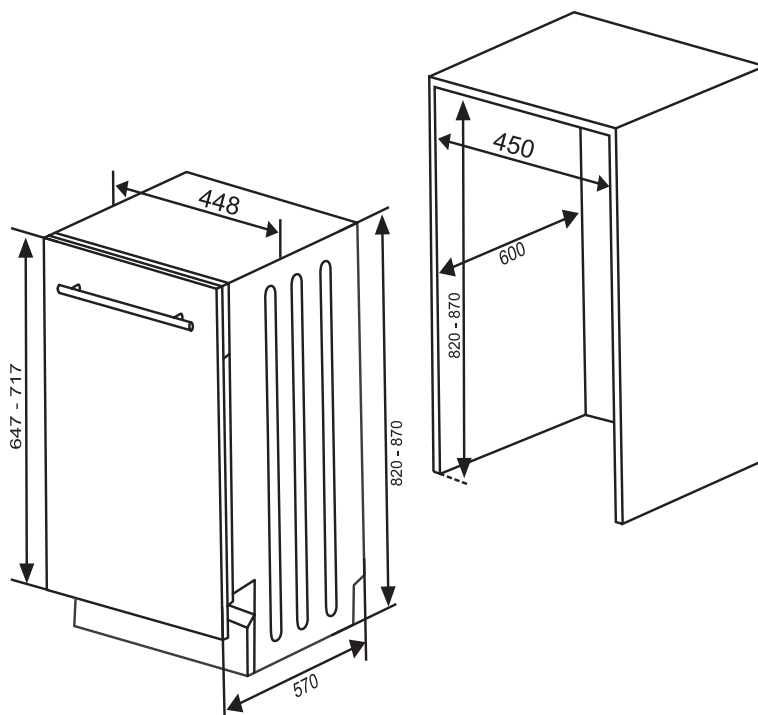



**STANDARD TUB  
(USA MODELS)**

**Semi-Integrated**

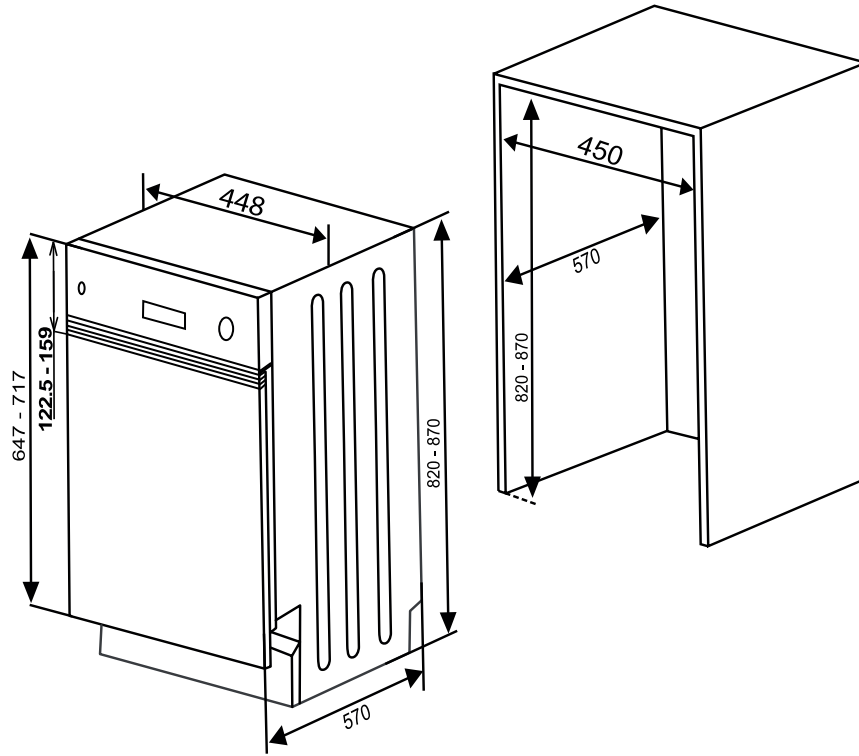

**Integrated**

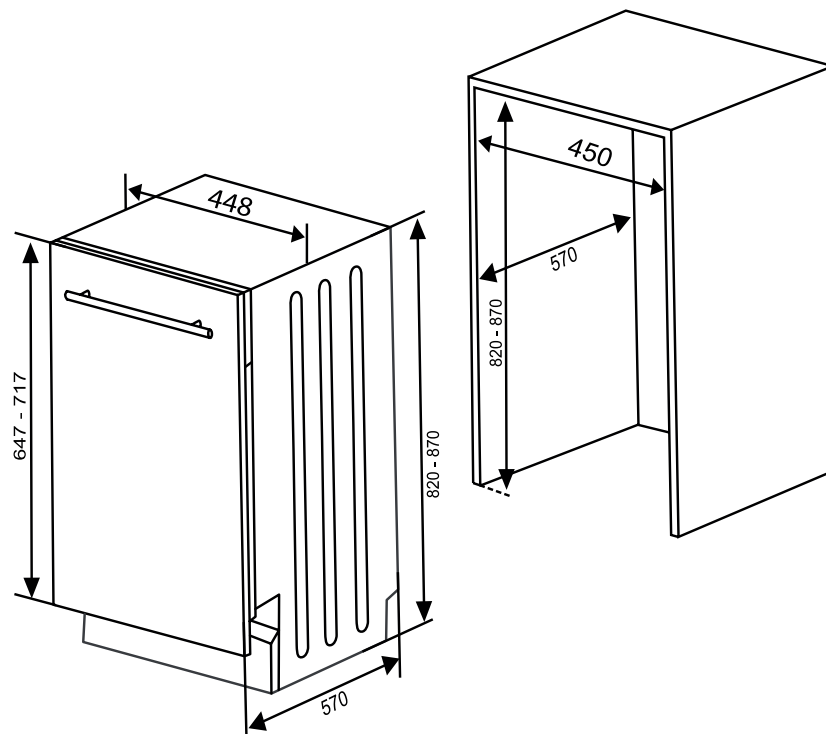

## Built-in Cookers Ovens

### **Single Ovens**

Standard - 50 / 65 / 75 LT

Pyrolyse - 50 / 65 / 75 LT

Steam Aided - 50 / 65 / 75 LT

### **Double Ovens**

Standard - 72 / 90 cm







185°C 00:43

VESTEL

The oven's control panel features a digital display and several touch-sensitive buttons. The display shows the temperature at 185°C and the time at 00:43. Below the display are several icons for different cooking functions and a lock symbol. The oven door has a large, curved stainless steel handle. The interior of the oven is visible through the glass door, showing two wire racks and a fan at the back.



PRODUCT FAMILY



**Built-in Oven**  
**Digital touch full programmer**



**Steam Assisted Compact Oven &**  
**Warmer Drawer Ready cook**



**Compact Oven & Warmer Drawer**  
**Digital touch full programmer**



**Pyrolytic Compact Oven & Warmer Drawer**  
**Pyrolytic digital touch programmer**



**Built-under Double Oven  
Digital touch full programmer**



**Built-in Double Oven  
Digital touch full programmer**



**Built-in coffee machine**







ready  
cook

READY COOK

## PRODUCT / ACCESSORY DESCRIPTION

Ready Cook is a new TFT interface with click type knob control for built in ovens.

We're very pleased to bring the color and clarity of TFT displays to a broader range of major home appliances with Vestel's Ready Cook, along with other advanced features previously available only in more high-end oven models.

Ready Cook is designed to help users cook professional recipes easily with auto cooking functions, also allowing the users to implement their own recipes with manual cooking functions. Using a user friendly interface with the colored TFT display creates the charm of Ready Cook compared to the existing models in the high end segment.

## FEATURES

- 4.3" TFT LCD Display
- Auto Cooking mode with 151 recipes
- Manual Cooking mode
- Favorites with 10 recipe slots which can be set by end user
- Vap Clean function
- Multi language support
- Real time clock and date adjustment
- 5 levels of display brightness
- 3 levels of buzzer tone
- Steam assisted option
- Wi-Fi option
- A+ energy efficiency option
- A++ energy efficiency option



## MENU



Manual cooking

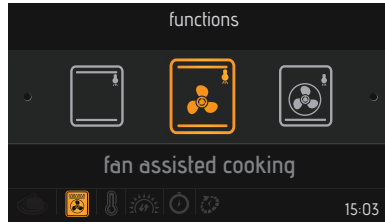

Function selection

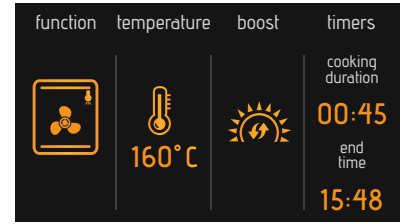

Cooking summary



Auto cooking

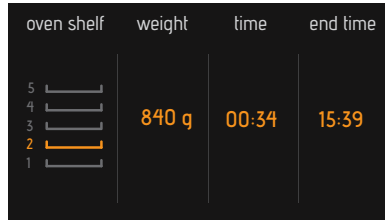

Cooking summary



Cooking animation

## RECIPES

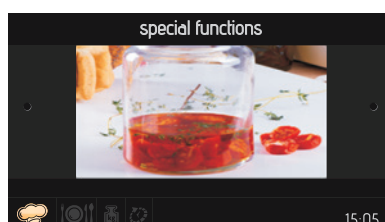
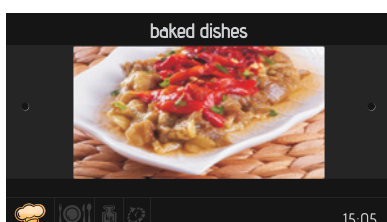
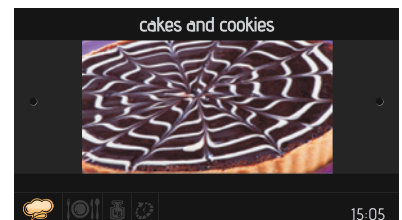
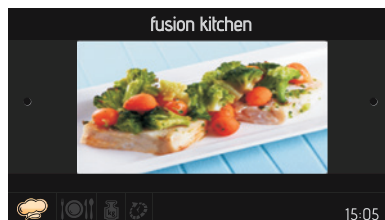
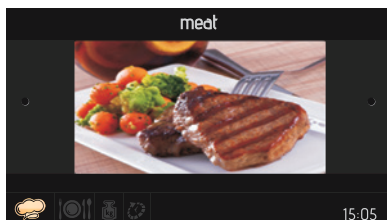
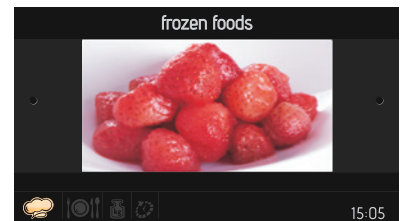
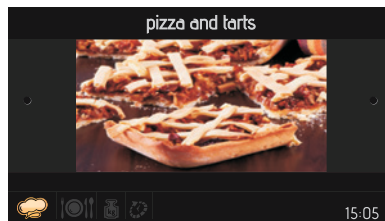
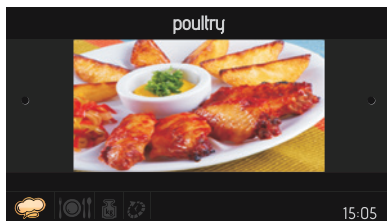
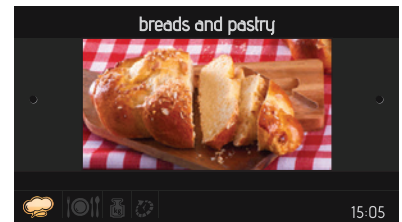
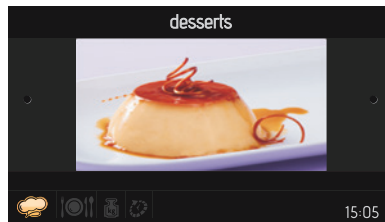
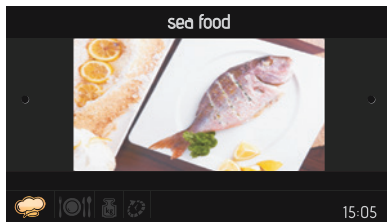



PyroClean

*During the pyrolytic cleaning process the oven heats up to approximately 480°C at which the temperature is kept for 1 hour while the door is locked for safety purposes.*

**At this temperature, residues from roasting, grilling and baking are reduced to a thin layer of ash that can simply be wiped away with a damp cloth.**





### Vap Clean

***With VapClean® function, dried food stains inside the oven cavity is softened with vapor.***

To perform VapClean® a glass of water is poured into the small tray which will be placed at the bottom of the oven. After that VapClean® function is activated to create vapor inside oven cavity which will soften dried food stains.



### Vap Clean +

**Only for steam assisted oven with Vapclean+ function, dried food leftovers inside the oven cavity are softened with vapor.**

**To perform Vapclean+ add 300ml of water into the water tank. After that,vapclean+ is activated to creat vapor inside oven cavity which will soften dried food stains.**





Heatwrap

***Perfect Cooking at 5 Levels!***

**Heatwrap technology allows cooking evenly at 5 levels in 75 lt built-in ovens. As well as uniform cooking at any level up to 4 types of dishes can be cooked without mixing the smell.**

**Patent pending.**



### 3D Cooking Function

- \*Homogenous heat distribution in all direction of cooking tray
- \*More dough rise for pastry
- \*Simultaneous operation of top, bottom and ring heating element with fan
- \*Automatic power management for heaters during operation

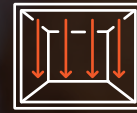

### HotAir Shield

*no more hot and humid air out*

When oven door is opened during cooking, it creates an airstream between control panel and oven bottom panel.

Hence, it prevents the hot and humid air coming out of the oven to reach the end user.

Available cavity volume: 50lt / 65 lt / 75lt

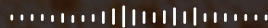

### Silent Operation

*low noise level built-in oven*

During the operation of oven noise level is A-weighted sound power level LwA of 35 dB.

A-weighted sound power level LwA of 35 dB is world record and certified by VDE.

Available cavity volume: 65lt / 75lt

Available control units: Visio Touch / Full Touch LEDSlim LED Touch



**A+ Energy Class for electronic and mechanic controlled built-in ovens**

Energy Efficiency Index(EEI) 62 to 82 are A+ Energy Class.

The world's first A+ ovens with mechanic controls.

Available cavity volume: 65lt / 75lt

Available control units: All control units

Available with all multifunction ovens (except pyrolytic).



**A++ smart lcd readycook built-in oven**

The World's first built-in oven in energy efficiency A++ by the help of TurboLite++ oven function. TurboLite++ is the name of the cooking function which provides A++ Energy Class with respect to EU regulation no 65/2014.

TurboLite++ function's declared values are as below.

Energy Consumption(EC): 0.52 kWh/cycle

Energy Efficiency Index(EEI): 61.9

Volume(V): 69lt



**DOOR TYPES**

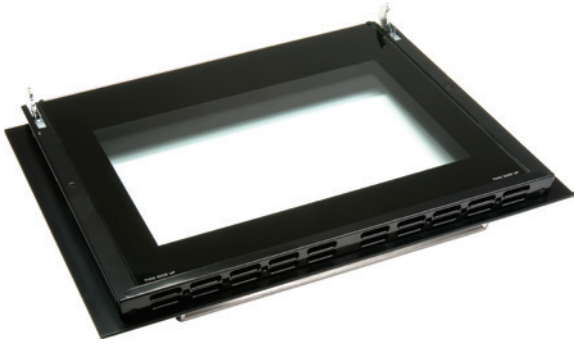

**TYPE 2**  
**Large Glass Oven Door**



**TYPE 3**  
**Pyrolytic Oven Door**



**TYPE 4**  
**Full Glass Oven Door**



**TYPE 5**  
**Active Cool Oven Door**



**TYPE 6**  
**Full Glass Oven Door**  
**Plastic Profile**



DOOR FEATURES

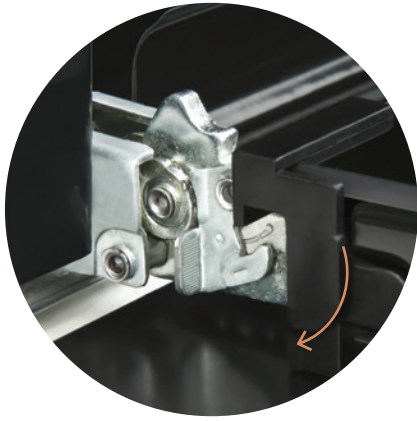

**Easy Removable Oven Door**

*For Full Glass Over Door And For Active Cool Oven Door*



**Easy Removable Oven Door**

*For Large Glass Oven Door and Pyrolytic Oven Door*



**Removable Inner Glass**



**Door Switch**



**Soft Close**

*For Full Glass And Active Cool Oven Door*



**Soft Open and Close Door**

*For Full Glass And Active Cool Oven Door*

**ADD-ON TYPES  
65 LT BUILT-IN OVENS**

**I TYPE**  
**add on 50 mm**  
*cladding*



**U TYPE**  
**add on 17 mm**  
*cladding*



**U TYPE**  
**add on 50 mm**  
*cladding*



**CORNER**  
**add on**  
*laser cut*



**RUSTIC**  
**add on**  
*cladding*



**MONO STRIPE**  
**add on 15 mm**  
*cladding*



**MONO STRIPE**  
**add on 50 mm**  
*cladding*



**DUO STRIPE**  
**add on**  
*cladding*



**TRIO STRIPE**  
**add on**  
*cladding*





**ADD-ON TYPES  
75 LT BUILT-IN OVENS**

**I TYPE**  
**add on 40 mm**  
*cladding*



**U TYPE**  
**add on 17 mm**  
*cladding*



**MONO STRIPE**  
**add on 50 mm**  
*cladding*



**TRIO STRIPE**  
**add on 50 mm**  
*cladding*



**U TYPE**  
**add on 40 mm**  
*cladding*



**O TYPE**  
**add on 40 mm**  
*cladding*



**DUO STRIPE**  
**add on 50 mm**  
*cladding*



ADD-ON TYPES  
50 LT BUILT-IN COMPACT OVENS

**I TYPE**  
add on 40 mm  
cladding



**U TYPE**  
add on 40 mm  
cladding



**O TYPE**  
add on 40 mm  
cladding



**MONO STRIPE**  
add on 50 mm  
cladding



**DUO STRIPE**  
add on 50 mm  
cladding



**TRIO STRIPE**  
add on 50 mm  
cladding





ADD-ON TYPES  
BUILT-IN DOUBLE OVENS

**I TYPE**  
add on 40 mm  
cladding



**U TYPE**  
add on 40 mm  
cladding



**MONO STRIPE**  
add on 50 mm  
cladding



**O TYPE**  
add on 40 mm  
cladding



COLOR OPTIONS



**Black**



**White**



**Pure Black**

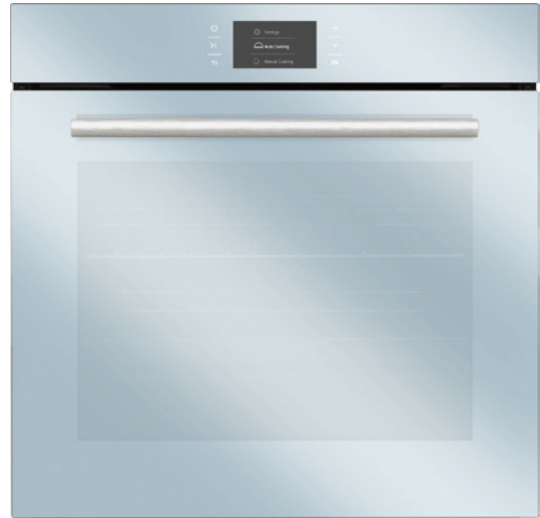

**Mirror**



**Dark Gray**



**Mink**

## WARMER DRAWER



Maximum 20 kg capacity or 6 dinner plates, 6 soup plates, 3 serving bowls and 2 platters

710W side and bottom heating element with tangential fan

30-70°C adjustable thermostat

90 minute cut off audible timer

On / off light

## COFFEE MACHINE



45cm single built-in compact coffee machine

Full touch control with LCD screen

Fully automatic



NEW CONTROL PANEL TYPES



Full Touch Timer



Visio Touch Timer



Digital Touch Timer

NEW CONTROL PANEL TYPES WITH METAL PRINT ADD-ON

*Inox on Glass*



**Full Touch Timer**



**Visio Touch Timer**



**Digital Touch Timer**

## MAIN COMPONENTS







**Electric Grill**



**Cooling Fan**



**Fan with The Ring for Multifunction Ovens**



**Pop in Pop Out Illuminated Knobs**



**Oven Lamp**



**Anti Fingerprint Inox Parts**



**Side Lighting**



**Pop In - Pop Out Water Tank**

**CONTROL PANEL TYPES**



**Smart LCD Ready Cook Control Panel**



**Slim LED Touch Control Panel (for 50lt and 75lt ovens)**

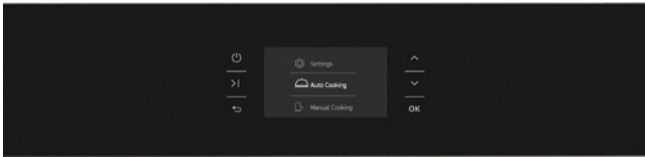

**Monochrome LCD Control Panel**



**Full Touch LED Control Panel**

**Visio Touch Control Panel**



**Glass**



**Metal**

**Digital Touch Full Programmer**



**Glass**



**Metal**

**Digital Full Programmer**



**Glass**



**Metal**

**Digital Touch Clock And Minute Minder**



**Glass**

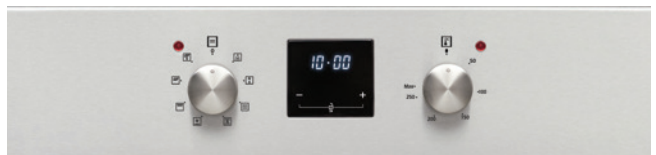

**Metal**

### Digital Clock And Minute Minder



Glass



Metal

### Pyrolytic Digital Touch Programmer



Glass



Metal

### Pyrolytic Digital Programmer



Glass



Metal

### Mechanical Timer



Glass



Metal

### Mechanical Minute Minder



Glass



Metal

### Analog Timer

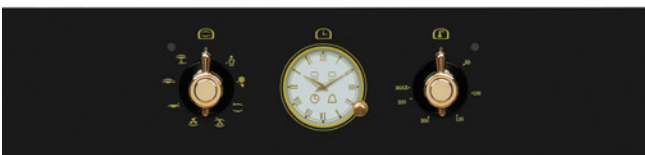

Glass



Metal





## CAVITY RACK TYPES

### Designed for ease of use

Vestel offers to various cavity racks according to consumer needs.  
The usage of the cavity racks is smooth and easy.

### Options



Enamel  
Mold Runners



Catalytic  
Enamel  
Side Panels



Wire Rack In  
Enamel Cavity



Wire Rack  
In Catalytic  
Enamel Cavity



Wire Rack of  
11 Shelves  
*(only 65lt cavity)*



Wire Rack of  
12 Shelves  
*(only 75lt cavity)*

## Telescopic Shelf

Vestel telescopic rails go in and out smoothly. The shelves allow to remove hot trays or pans from the oven easily and practically.



## Full Extension Telescopic Shelf

Thanks to full extension telescopic shelves, consumers can reach whole of tray or pan so they can check, turn and spice their food without having to put their hands in the oven.



### Options



Single Telescopic Shelf



Double Telescopic Shelves



Full Extension Telescopic Shelf



Double Full Extension Telescopic Shelves



KNOB TYPES

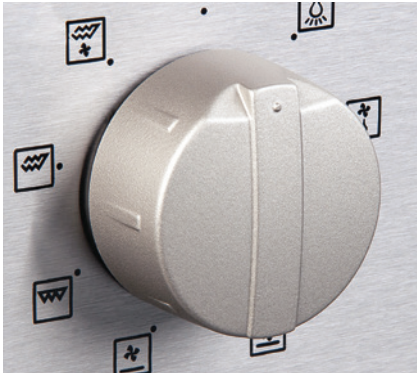

**Antero**



**Alfa**



**Macro**



**Eclipse**



**Trio**



**Primus**



**Rimo**



**Gama**



**Flat**



**Nord**



**Jannu**



**Linea**





**Feros**



**Zenith**



**Flat Pipo**



**Pipo with illuminated**



**Pipo**



**Rustic Gold**



**Rustic Antique Gold**

HANDLE TYPES

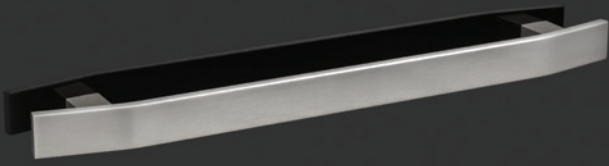

3D Quadrangle

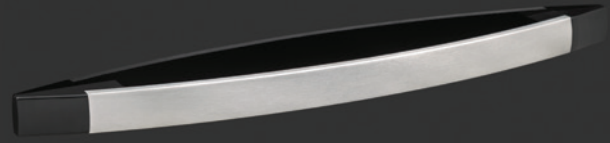

Arc Quadrangle

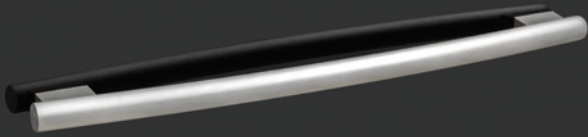

Arc Tube

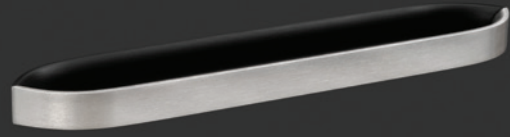

Bow

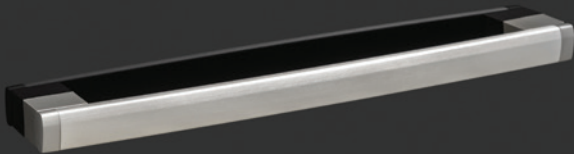

Curved Quadrangle

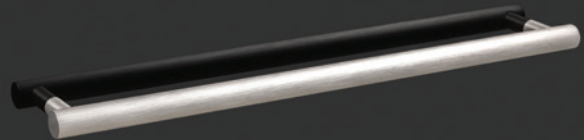

Cylinder

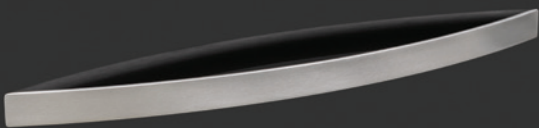

D Profile Arc

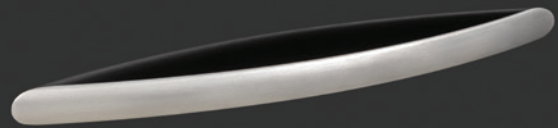

Ellipse Arc

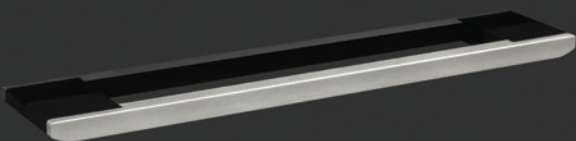

V-Line

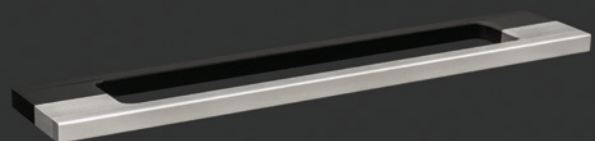

Verge

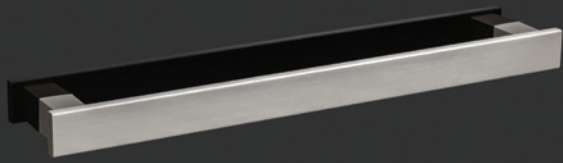

**Flat Quadrangle**

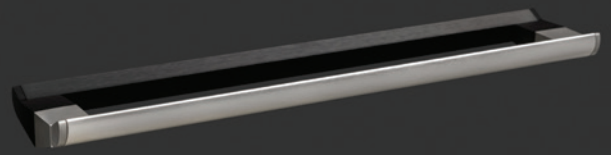

**Flat Slice**

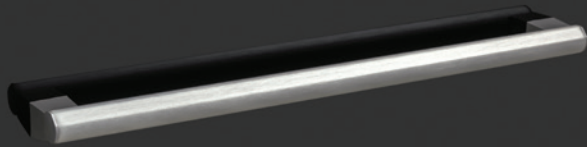

**Trio**

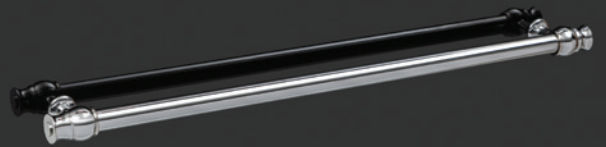

**Rustic**

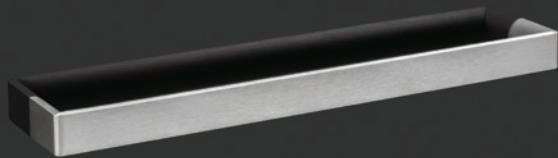

**Vero**

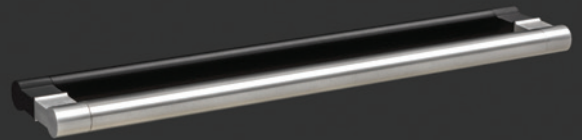

**Troy**

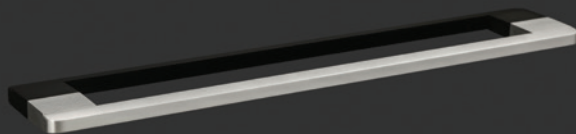

**Slim Bar**

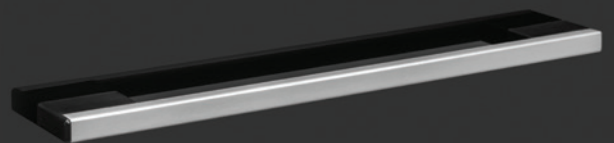

**Square Bar**

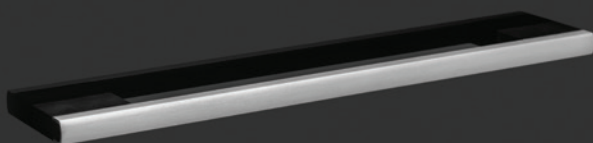

**Trim**



## ACCESSORIES



## TRAYS



**Grill Pan Handle Set**



**Chromed Wire Grid**





**Shallow Tray**



**Deep Tray**



**80 mm Deep Tray**



**Chromed Wire Grid For Deep Tray and Shallow Tray**





**Pizza Set**



**Grill Pan Handle**

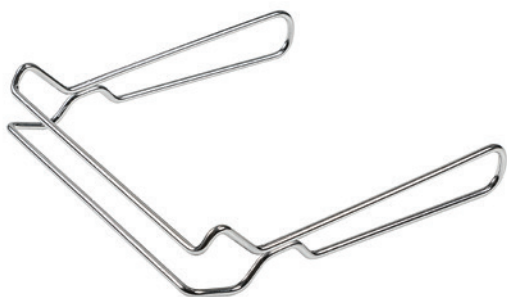

**Heavy Duty Grill Pan**



**VestFRY**





**Time saving cooking with Vestel Pizza Set**

*Cook pizza just in 15 min.*

**Fry in a healthier way with VestFry**

*Fry vegetables or meat with just one spoon of oil.*



**Oil Filter**



**Meat Probe**



**Turnspit Set with Grid**



**Turnspit Set with Metal Bracket**

# 60cm Built-in Oven Specification Sheet

60 cm Electric Built-in Oven

60 cm Pyrolytic Built-in Oven

60 cm Electric Polyvalente Built-in Oven

---

## Oven Features

---

Easy to Clean Enamel

---

Catalytic Enamel Panels (Left, right and rear)

---

## Pyrolytic Enamel

---

Wire Side Racks

---

Telescopic Rails (1 or 2 racks)

---

Top Heating Element

---

Bottom Heating Element

---

Thermostat

---

Grill (Thermostatic)

---

Double Grill (Thermostatic)

---

Fan

---

Fan with Ring Heating Element

---

Automatic Boost Function

---

Turnspit

---

Thermostat Operation Indicator Light

---

Oven Operation Indicator Light

---

Hotplate Operation Indicator Light  
(in case of polyvalente oven)

---

Oven Door Switch

---

Oven Door lock indicator light

---

Minute Minder

---

Mechanical Timer

---

Analog Timer

---

Digital Clock

---

Digital Programmer

---

Digital Programmer with touch interface

---

Full Touch LED Display

---

Knob Control LED Display and  
Touch Interface (Visio Touch)

---

Smart LCD (Ready Cook)

---

Monochrome LCD

---

---

## Oven Door

---

Full outer glass and small inner glass  
with metal frame (4 glasses)

---

Full inner glass and full glass front  
face (4 glasses) Oven Door

---

Full outer glass and full inner glass Oven Door

---

Full inner glass and full glass front face Oven Door

---

Cool touch Oven door

---

Flotal Oven Door Glass

---

Removable Oven Door

---

Various Types of Inox Add-on on Oven Door Glass

---

Child Lock on Oven Door

---

## Accessories

---

Oven Light (25W)

---

Oven LED Light

---

Oil Filter

---

Meat Probe

---

Baking Tray (Shallow Tray)

---

Roasting Tray (Deep Tray)

---

Chromed Grid with Stoper

---

Wire grid for deep tray

---

Grill Pan with Handle Set

---

Turnspit

---

VestFRY

---

## Packaging

---

Shrink Packaging

---

Carton Box Packaging

---



## **BI.01**

### **Features**

- 60 cm built-in double electric oven
- 39 L top oven inner cavity
- 78 L main oven inner cavity
- 90 cm height
- Digital touch full programmer
- Inox pop-in pop-out knobs with flat cap
- Inox handle
- Black glass control panel and oven door



## **BU.01**

### **Features**

- 60 cm built-under double electric oven
- 39 L top oven inner cavity
- 50 L main oven inner cavity
- 72 cm height
- Digital touch full programmer
- Metal clad knobs
- Inox handle
- Black glass control panel and oven door





## CO.01 *Steam Assist*

### **Features**

- 45cm single built-in compact electric oven
- 50 L inner cavity
- Steam-assisted cooking
- Smart LCD Ready Cook control panel
- Metal clad knobs
- Inox handle
- Black glass control panel and oven door
- Warmer drawer



## CO.02 *Pyrolytic*

### **Features**

- 45cm single built-in compact electric oven
- 50 L inner cavity
- Pyrolytic Function
- Visio Touch control panel
- Inox pop-in pop-out knobs with flat cap
- Inox handle
- Black glass control panel and oven door
- Warmer drawer



## CO.03 *Multifunctional*

### **Features**

- 45cm single built-in compact electric oven
- 50 L inner cavity
- Slim LED Touch control panel
- Inox handle
- Black glass control panel and oven door
- Warmer drawer



## **BO.110**

### **Features**

- 60 cm single built-in electric oven
- 75 lt inner cavity
- Steam-assisted cooking
- Smart LCD Ready Cook control panel
- Inox knob
- Inox handle
- Horizontal inox add-on control panel and oven door



## **BO.94**

### **Features**

- 60 cm single built-in electric oven
- 75 lt inner cavity
- Smart LCD Ready Cook control panel
- Inox knob
- Inox handle
- U type slim inox add-on control panel
- U type slim inox add-on oven door



## **BO.112**

### **Features**

- 60 cm single built-in electric oven
- 75 lt inner cavity
- Smart LCD Ready Cook control panel
- Inox knob
- Inox handle
- Pure black glass oven door
- Hot air shield



## BO.113

### Features

- 60 cm single built-in electric oven
- 75 lt inner cavity
- Slim LED Touch control panel
- Inox knob
- U type slim inox add-on control panel
- U type slim inox add-on oven door



## BO.109

### Features

- 60 cm single built-in electric oven
- 75 lt inner cavity
- Full Touch LED control panel
- White colored display
- Inox handle
- Side vertical inox cladding add-on control panel
- Side vertical inox cladding add-on oven door



## BO.105

### Features

- 60 cm single built-in electric oven
- 75 lt inner cavity
- Monochrome control panel
- Black glass control panel and over door
- Black painted handle





## **BO.106**

### **Features**

- 60 cm single built-in electric oven
- 75 lt inner cavity
- Visio Touch control panel
- Slim inox control panel
- White colored display
- Inox pop-in pop-out knobs
- Inox handle
- Horizontal inox add-on oven door



## **BO.96**

### **Features**

- 60 cm single built-in electric oven
- 75 lt inner cavity
- Visio Touch control panel
- White colored display
- Inox pop-in pop-out knobs
- Inox handle
- White optical glass slim control panel
- White optical glass oven door



## **BO.115 Pyro**

### **Features**

- 60 cm single built-in electric oven
- 75 lt inner cavity
- Pyrolytic Function
- Pyrolytic Digital touch full programmer
- White colored display
- Inox control panel
- Inox handle
- Inox painted knobs
- U type inox add-on oven door



## **BO.120**

### **Features**

- 60 cm single built-in electric oven
- 75 lt inner cavity
- Digital touch full programmer
- White colored display
- Dark inox slim control panel
- Dark inox painted knob
- Dark inox handle
- O type dark inox add-on oven door



## **BO.97**

### **Features**

- 60 cm single built-in electric oven
- 75 lt inner cavity
- Digital touch full programmer
- White knobs
- White handle
- White optical glass slim control panel
- White optical glass oven door



## **BO.99**

### **Features**

- 60 cm single built-in electric oven
- 75 lt inner cavity
- Mechanical timer
- Inox pop-in pop-out knobs
- Inox handle
- O type inox add-on control panel
- O type inox add-on oven door



## **BO.86** Ready Cook

### **Features**

- 60 cm single built-in electric oven
- Smart LCD Ready Cook control panel
- Metal clad knobs
- Inox handle
- U type inox add-on control panel
- U type inox add-on oven door



## **BO.87** Ready Cook

### **Features**

- 60 cm single built-in electric oven
- Smart LCD Ready Cook control panel
- Metal clad knobs
- Inox handle
- Mirror glass control panel and over door
- Side vertical inox add-on control panel
- Side vertical inox add-on oven door



## **BO.88** Ready Cook

### **Features**

- 60 cm single built-in electric oven
- Steam-assisted cooking
- Smart LCD Ready Cook control panel
- Metal clad knobs
- Inox handle
- Black glass control panel and over door





## **BO.66** Full Touch

### **Features**

60 cm single built-in electric oven  
Full Touch LED control panel  
White colored display  
Inox handle  
Horizontal inox add-on control panel  
Horizontal inox add-on oven door



## **BO.70** Full Touch

### **Features**

60 cm single built-in electric oven  
Full Touch LED control panel  
White colored display  
Inox handle  
Side vertical inox add-on control panel  
Side vertical inox add-on oven door



## **BO.116** Monochrome

### **Features**

60 cm single built-in electric oven  
Monochrome control panel  
Black glass control panel and oven door  
Inox handle  
U type slim inox add-on control panel  
U type slim inox add-on oven door



## **BO.77** Visio Touch

### **Features**

- 60 cm single built-in electric oven
- Visio Touch control panel
- White colored display
- White colored illuminated Inox pop-in pop-out knobs
- Inox handle
- Horizontal inox add-on control panel
- Horizontal inox add-on oven door



## **BO.78** Visio Touch

### **Features**

- 60 cm single built-in electric oven
- Visio Touch control panel
- White colored display
- Inox pop-in pop-out knobs
- Inox handle
- White optical glass control panel and oven door
- U type inox add-on control panel
- U type inox add-on oven door



## **BO.83** Visio Touch

### **Features**

- 60 cm single built-in electric oven
- Visio Touch control panel
- White colored display
- Inox control panel
- Inox pop-in pop-out knobs
- Inox handle
- Horizontal inox add-on oven door



## **BO.85** Pyro

### **Features**

60 cm single built-in electric oven  
65 lt inner cavity  
Pyrolytic Function  
Visio Touch control panel  
White colored display  
Inox pop-in pop-out knobs  
Inox handle  
Side vertical inox add-on oven door



## **BO.67** Pyro

### **Features**

60 cm single built-in electric oven  
65 lt inner cavity  
Pyrolytic Function  
Full Touch LED control panel  
White colored display  
Inox handle  
Horizontal inox add-on control panel  
Horizontal inox add-on oven door



## **BO.65** Pyro

### **Features**

60 cm single built-in electric oven  
Pyrolytic Function  
Pyrolytic Digital touch full programmer  
White colored display  
Inox painted knobs  
Inox handle  
Side vertical inox add-on oven door  
U type inox add-on control panel





## **BO.89** Pyro

### **Features**

60 cm single built-in electric oven  
Pyrolytic Function  
Pyrolytic digital timer  
White colored display  
Inox pop-in pop-out knobs  
Inox handle  
Horizontal inox add-on oven door



## **BO.90** Pyro

### **Features**

60 cm single built-in electric oven  
Pyrolytic Function  
Pyrolytic digital timer  
White colored display  
White painted glass control panel  
White painted glass oven door  
White painted knobs and handle



## **BO.117**

### **Features**

60 cm single built-in electric oven  
Digital touch full programmer  
White colored display  
Inox control panel  
Black glass oven door  
Inox handle  
Metal clad knobs  
U type inox add-on oven door



## **BO.122**

### **Features**

60 cm single built-in electric oven  
65 lt inner cavity  
Digital touch full programmer  
White colored display  
Dark grey colored optical glass control panel and oven door  
Metal cladded knobs  
Inox handle



## **BO.42**

### **Features**

60 cm single built-in electric oven  
Digital full programmer  
White colored display  
Inox pop-in pop-out knobs  
Inox handle  
Mink colored optical glass control panel and oven door



## **BO.100**

### **Features**

60 cm single built-in electric oven  
Digital touch full programmer  
White colored display  
Metal cladded knobs  
Inox handle  
U type slim inox add-on control panel  
U type slim inox add-on oven door



## **BO.74**

### *Features*

- 60 cm single built-in electric oven
- Digital full programmer
- White colored display
- White colored illuminated pop-in pop-out knobs
- Inox handle
- U type slim inox add-on control panel
- U type slim inox add-on oven door



## **BO.05**

### *Features*

- 60 cm single built-in electric oven
- Digital full programmer
- White colored display
- Inox painted knobs
- Inox handle
- Black glass control panel and oven door
- U type inox add-on control panel
- U type inox add-on oven door



## **BO.82**

### *Features*

- 60 cm single built-in electric oven
- Digital full programmer
- White colored display
- Inox pop-in pop-out knobs
- Inox handle
- Corner type laser cut inox add-on control panel





## **BO.37**

### **Features**

60 cm single built-in electric oven  
Digital clock and minute minder  
White colored display  
Black knobs  
Black handle  
Black painted metal control panel  
Black glass oven door



## **BO.24**

### **Features**

60 cm single built-in electric oven  
Digital touch clock and minute minder  
White colored display  
Metal cladded knobs  
Inox handle  
Black glass control panel  
Black glass oven door



## **BO.26**

### **Features**

60 cm single built-in electric oven  
Digital clock and minute minder  
White colored display  
White painted knobs  
White painted handle  
White painted metal control panel  
White painted glass oven door



## **BO.36**

### *Features*

60 cm single built-in electric oven  
Digital clock and minute minder  
White colored display  
Inox painted knobs  
Inox handle  
Inox control panel  
Black glass oven door



## **BO.39**

### *Features*

60 cm single built-in electric oven  
Mechanical timer  
Inox knob  
Inox handle  
Mirror glass oven door



## **BO.17**

### *Features*

60 cm single built-in electric oven  
Mechanical timer  
Inox painted knobs  
Inox handle  
Inox control panel  
Horizontal inox add-on oven door



## BO.09

### Features

- 60 cm single built-in electric oven
- Mechanical timer
- White painted knobs
- White painted handle
- Black painted glass control panel and oven door
- Side vertical white serigraphy on control panel
- Side vertical white serigraphy on oven door



## BO.25

### Features

- 60 cm single built-in electric oven
- Mechanical timer
- Black painted knobs
- Black painted handle
- TDF optical glass control panel
- TDF optical glass oven door



## BO.29

### Features

- 60 cm single built-in electric oven
- Mechanical timer
- White knobs
- White handle
- White painted metal control panel
- White painted glass oven door





## **BO.118**

### *Features*

60 cm single built-in electric oven  
Metal cladded knobs  
Inox handle  
Black glass control panel  
Black glass oven door



## **BO.18**

### *Features*

60 cm single built-in electric oven  
Inox painted knobs  
Inox handle  
Inox control panel  
Black glass oven door



## **BO.30**

### *Features*

60 cm single built-in electric oven  
White painted knobs  
White painted handle  
White painted metal control panel  
White glass oven door



## **BO.121**

### **Features**

- 60 cm single built-in electric oven
- Rustic style Risus knobs
- Rustic style Risus handle
- Black rustic style cladding add-on control panel
- Black rustic style cladding add-on oven door



## **BO.108**

### **Features**

- 60 cm single built-in electric oven
- Analog timer
- Rustic style Risus knobs
- Rustic style Risus handle
- Sand colored rustic style cladding add-on control panel
- Sand colored rustic style cladding add-on oven door



## **BO.119**

### **Features**

- 60 cm single built-in electric oven
- Mechanical timer
- Rustic style Risus knobs
- Rustic style Risus handle
- White colored rustic style cladding add-on control panel
- White colored rustic style cladding add-on oven door

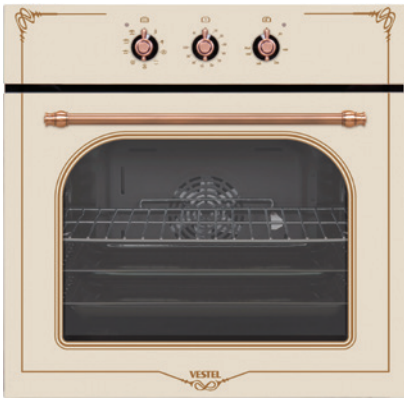

## **BO.50**

### **Features**

- 60 cm single built-in electric oven
- Mechanical timer
- Rustic style Risus knobs
- Rustic style Risus handle
- Type-C rustic design artwork
- Sand colored rustic style cladding add-on oven door



## **BO.48**

### **Features**

- 60 cm single built-in electric oven
- Analog timer
- Rustic style Risus knobs
- Rustic style Risus handle
- Type-A rustic design artwork
- Black glass control panel and oven door



## **BO.46**

### **Features**

- 60 cm single built-in electric oven
- Rustic style Risus knobs
- Rustic style Risus handle
- Type-B rustic design artwork
- White optical glass control panel
- White optical glass oven door





## **BO.101**

### **Features**

60 cm combi electric oven  
75 lt inner cavity  
Digital touch full programmer  
White colored display  
Inox pop-in pop-out knobs  
Inox handle  
Black glass slim control panel



## **BO.111**

### **Features**

60 cm combi electric oven  
75 lt inner cavity  
Digital touch full programmer  
White colored display  
Metal clad knobs  
Inox handle  
Inox slim control panel  
O type inox add-on oven door



## **BO.102**

### **Features**

60 cm combi electric oven  
75 lt inner cavity  
Digital full programmer  
White colored display  
Inox pop-in pop-out knobs  
Inox handle  
Inox slim control panel



## **BO.103**

### *Features*

60 cm combi electric oven  
75 lt inner cavity  
Mechanical timer  
Inox pop-in pop-out knobs  
Inox handle  
Inox slim control panel  
U type inox add-on oven door



## **BO.91**

### *Features*

60 cm combi electric oven  
Visio Touch control panel  
White colored display  
Black glass control panel  
Inox pop-in pop-out knobs  
Inox handle



## **BO.104**

### *Features*

60 cm combi electric oven  
Digital touch full programmer  
White colored display  
Inox painted knobs  
Inox handle  
Black glass control panel and oven door  
Horizontal inox add-on control panel  
Horizontal inox add-on oven door



## BO.02

### Features

- 60 cm combi electric oven
- Digital full programmer
- White colored display
- Inox pop-in pop-out knobs
- Inox handle
- Inox control panel
- Side vertical inox add-on oven door



## BO.69

### Features

- 60 cm combi electric oven
- Digital full programmer
- White colored display
- Inox pop-in pop-out knobs
- Inox handle
- White optical glass control panel and oven door
- Side vertical inox add-on control panel
- Side vertical inox add-on oven door



## BO.58

### Features

- 60 cm combi electric oven
- Mechanical timer
- White metal control panel
- White painted knobs
- White painted handle
- White painted glass oven door



# Built-in Cookers Hobs

## **Built-in Hobs**

60 cm

70 cm

75 cm

78 cm

90 cm

## **Domino Hobs**

30 cm



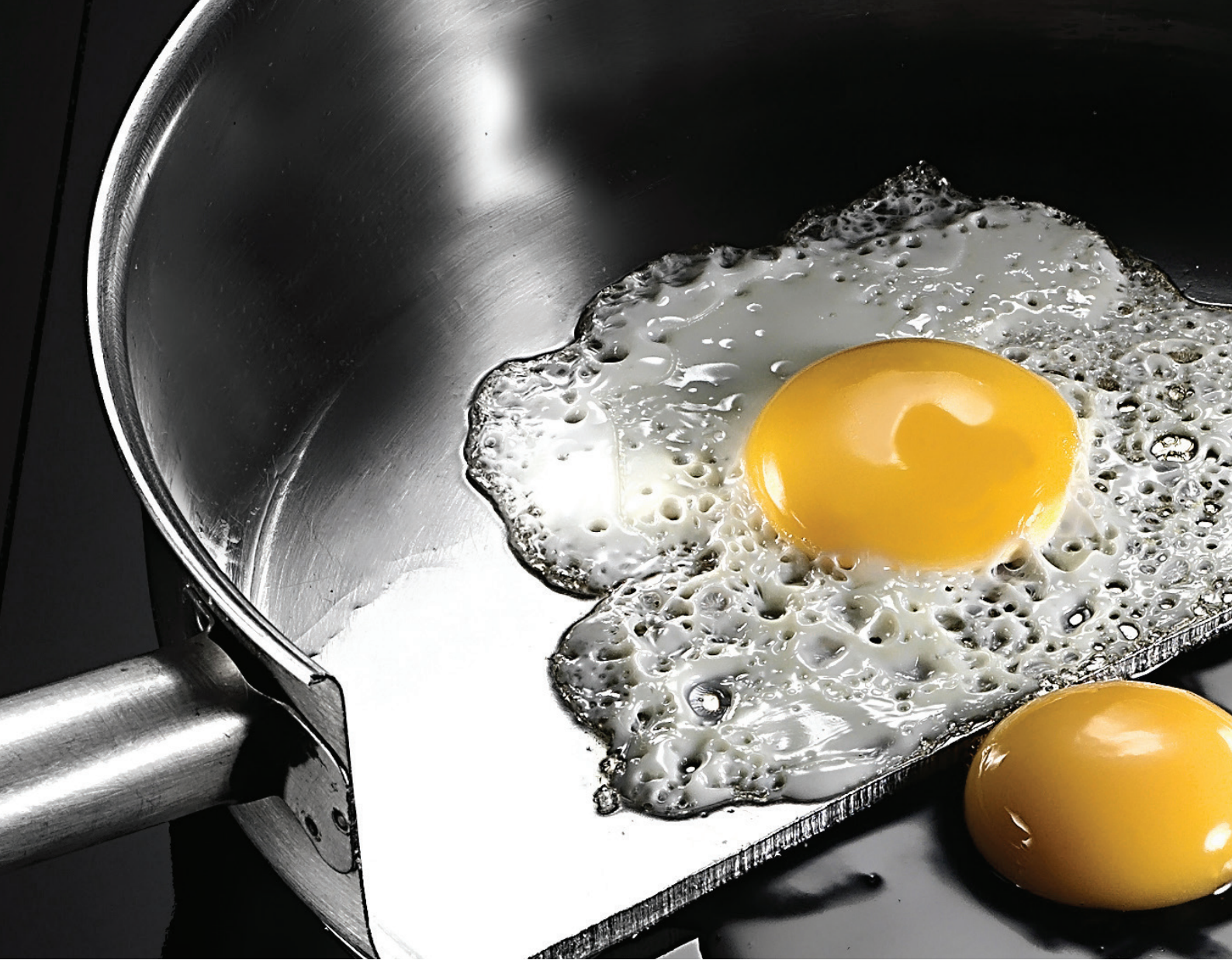

## 100% Vestel Induction Technology



### Speed Heating

Quick heating with PowerBoost



### Touch Control

Easy to Use with touch control unit



### Delay Timer

Cooking duration control with Timer



### Child Lock

Safe usage with Child Lock



### Chocolate Melting

Special function for chocolate melting (40°C)



### Boiling Mode

Fixes the cooking zone in boiling temperature (100°C)



### Frying Mode

Fixes the cooking zone in frying temperature (160°C)



### Keep Warm

Keeps the cooking zone in 50°C





  
**Pause Function**

Will pause all the cooking in all zones and restart it from the same power levels when pressed again. Keeps the paused zones warm.

  
**Key Lock**

Key lock function is for to block and to set the appliance in a safe mode during operation and cleaning.

  
**Auto Off**

The hob will shut off automatically if left idle for a long time. (1, 5 to 6 hours depending on the power level)

  
**Bridge Zone**

This function locks two zones to act as a single zone for using large utensils.

  
**High Efficiency**

High Efficiency with low energy consumption

  
**Easy Clean**

Easy to clean thanks to special glass surface

  
**Safety Function**

Thermal cut off system  
Safe usage with pan detector  
The glass surface is not directly heated thanks to the induction technology.

  
**V-Flex**

Allows you to control the cooking zones as you wish.



TOUCH CONTROL PANEL TYPES

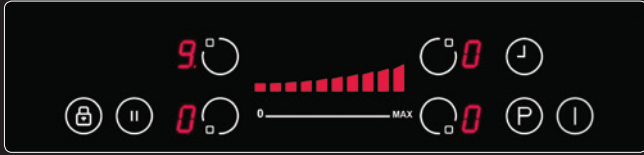

**Slider Touch Control Panel for Slim Design**  
for induction hobs Series II

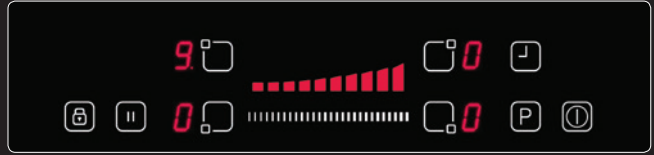

**Slider Touch Control Panel-1**  
for induction hobs Series II



**Slider Touch Control Panel-2**  
for induction hobs

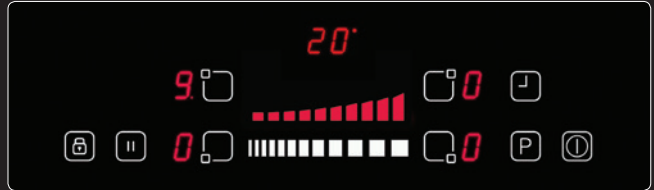

**Slider Touch Control Panel-1**  
for induction hobs

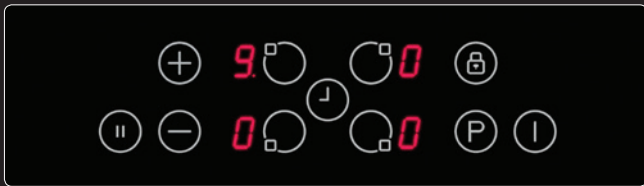

**Touch Control Panel**  
for induction hobs



**Touch Control Panel**  
for induction poly hobs

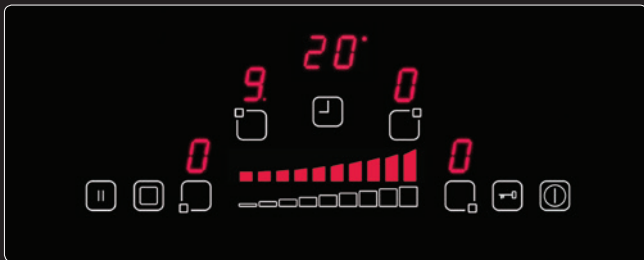

**Slider Touch Control Panel**  
for vitroceramic hobs

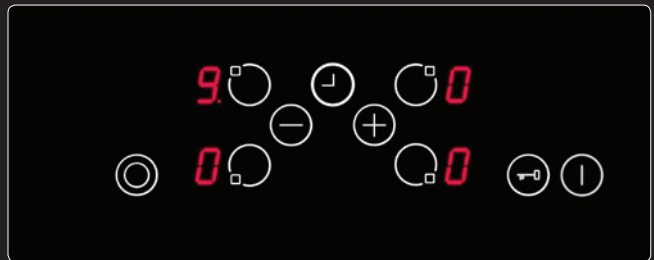

**Touch Control Panel**  
for vitroceramic hobs



**Touch Control Panel**  
for domino induction hobs

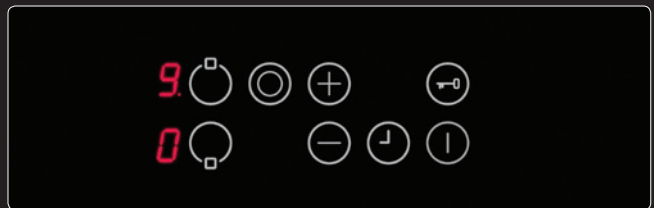

**Touch Control Panel**  
for domino vitroceramic hobs

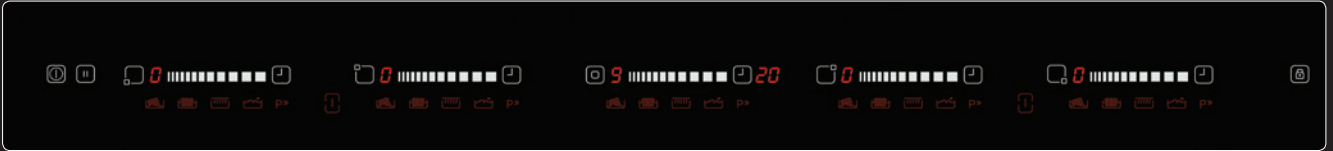

**Slider Touch Control Panel For 90 cm Induction Hobs**

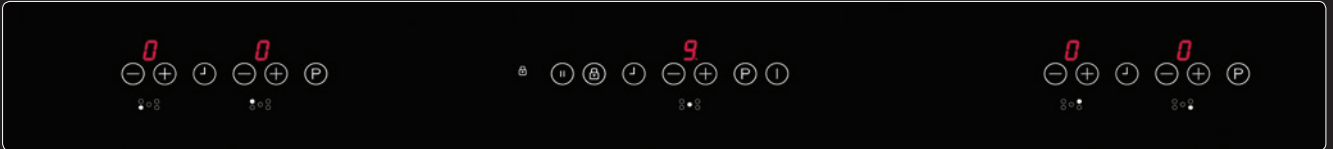

**Touch Control Panel For 90 cm Induction Hobs *Single On/Off***

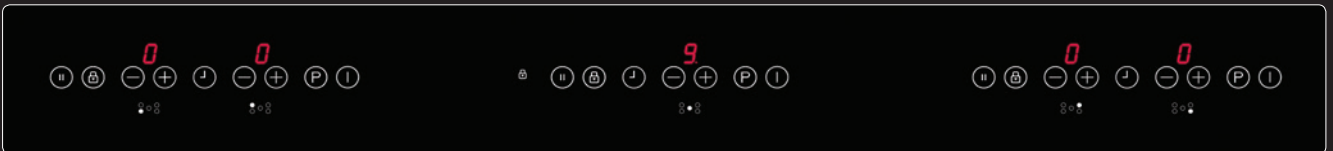

**Touch Control Panel For 90 cm Induction Hobs**

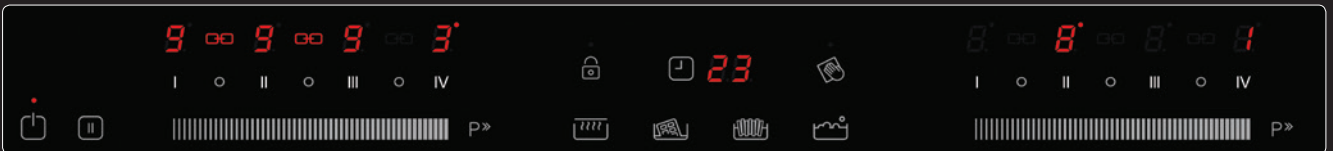

**V-Flex Induction Hobs**

CERAN HOB DETAILS



180 mm Dual Zone For Vitroceramic Hobs



145 mm Oval Zone For Vitroceramic Hobs



210 mm Triple Zone For Vitroceramic Hobs

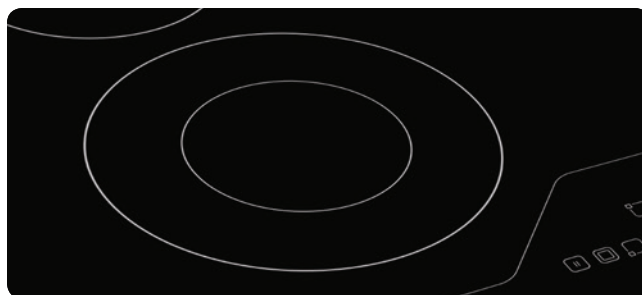

210 mm Dual Zone For Vitroceramic Hobs

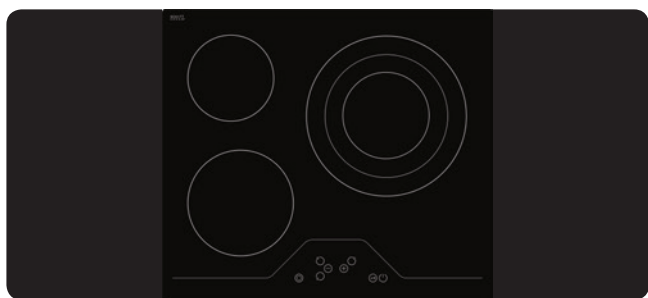

290 mm Triple Zone For Vitroceramic Hobs



290 mm Dual Zone For Vitroceramic Hobs

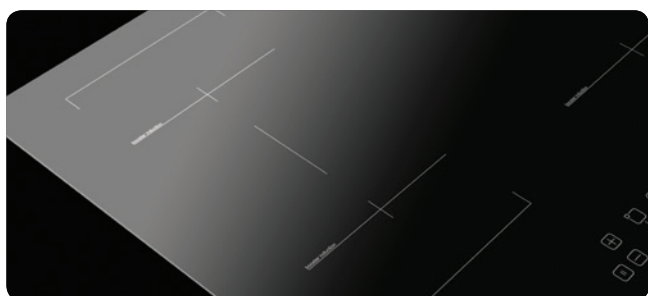

Bridge Zone



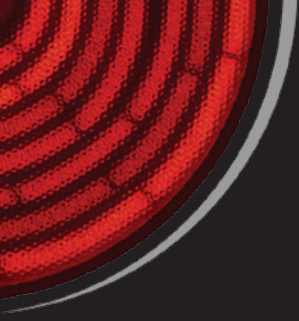

**Highlight Heating Element**



**Radiant Heating Element**



**Hot Surface Indicator Light For Vitroceramic Hobs**

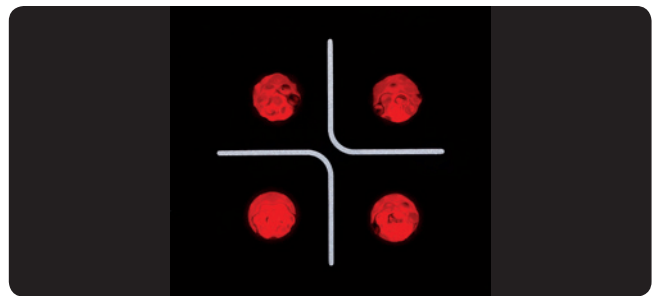

**Hot Surface Indicators For Vitroceramic Hobs**

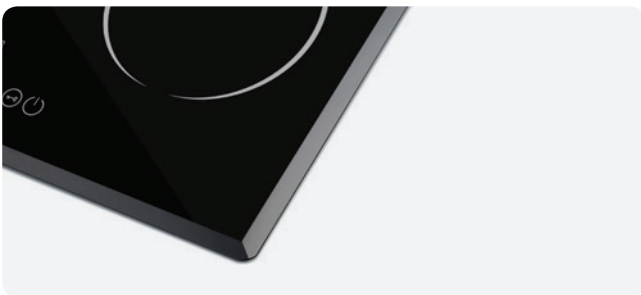

**Bevelled Edges For Vitroceramic Hobs**

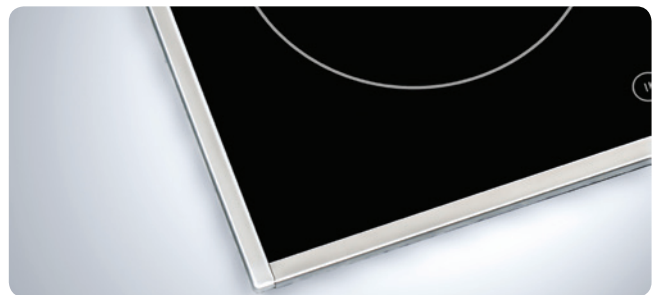

**Inox Frame**

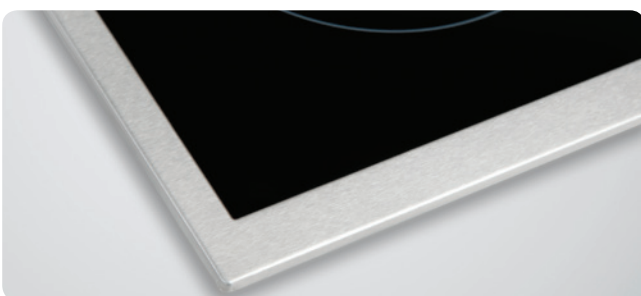

**Full Inox Frame**

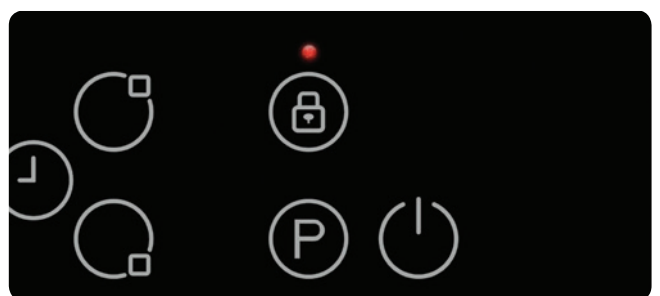

**Key Lock For Induction Hobs**

CERAN GLASS DESIGNS

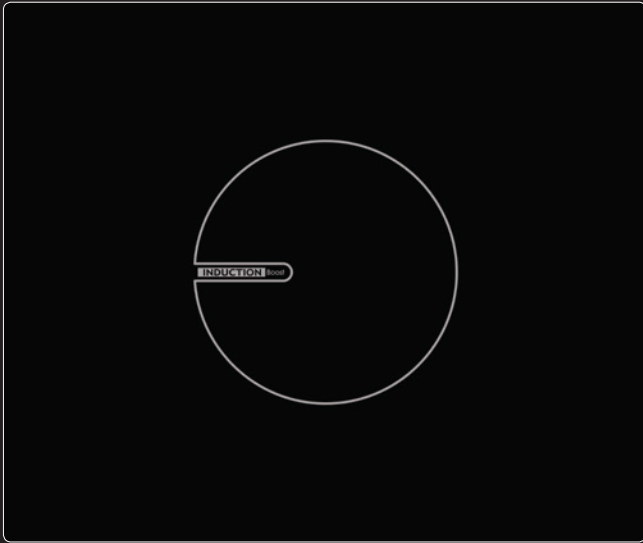

**Slim Design** for induction hobs

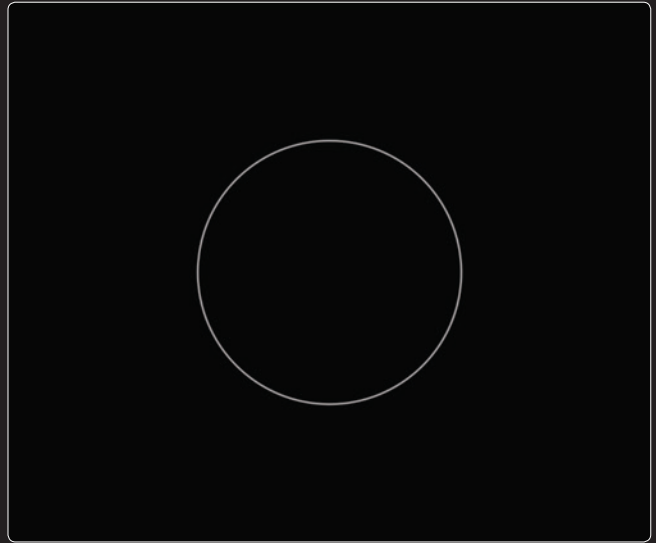

**Slim Design** for vitroceramic hobs



**Line Design** for induction hobs



**Plus Design** for induction hobs

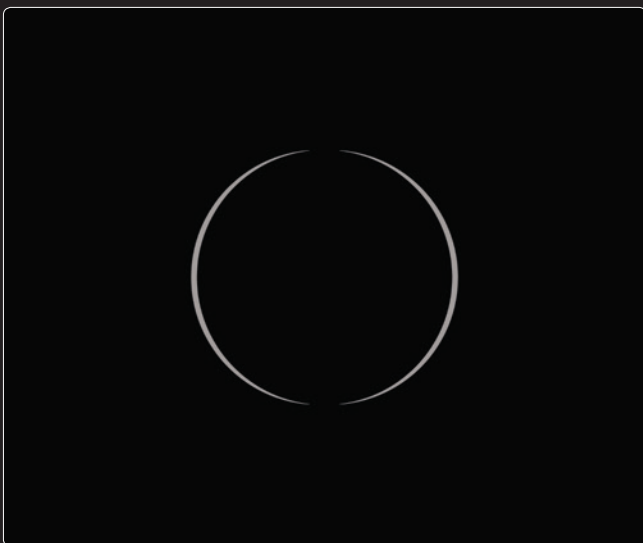

**Arc Design** for vitroceramic hobs

GAS ON GLASS HOB PAN SUPPORT TYPES



**Standard type enamel pan support**



**PlusX type Enamel Pan Support**



**Standard type mat enamel pan support**



**PlusX type mat enamel pan support**



**Standard type cast iron pan support**



**PlusX type cast iron pan support**



**Profile type enamel pan support**



**Line Pan Supports (Gas On Glass)**



PAN SUPPORT TYPES



Line type cast iron pan support for 60cm PlusX hob

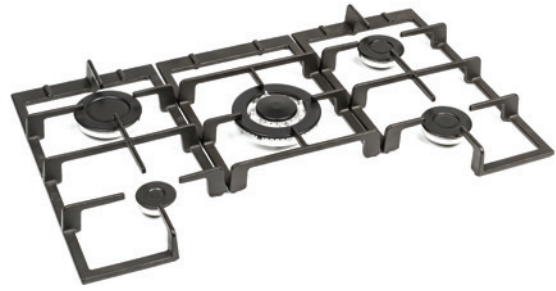

Line type cast iron pan support for 70cm PlusX hob



Deluxe type cast iron pan support for 60cm PlusX hob



Deluxe type cast iron pan support for 70cm PlusX hob



Division type cast iron pan support



S type cast iron pan support only 90cm hob



Semi Flat for 60 cm



Semi Flat for 70 cm



**S-Type**



**V-Type**



**D-Type**



**S-Type Cast Iron**



**S-Type Cast Iron PlusX 60cm**



**S-Type Cast Iron PlusX 70cm**



**Extenda Cast Iron**



**Division Cast Iron**



HOB DETAILS



**Enamel Pan Supports**



**Mat Enamel Pan Supports**



**Cast Iron Pan Supports**



**Enamel Burner Pan And Enamel Pan Support** for gas on glass hobs



**Mat Enamel Burner Pan And Cast Iron Pan Support** for gas on glass hobs



**Inox Burner Pan And Mat Enamel Pan Supports** for gas on glass hobs



**Enamel Burner Cap**



**Enamel Flat Burner Cap**



**Mat Enamel Burner Cap**



**Cast Iron Burner Cap**





**Coffie Support**



**Cast Iron Coffie Support**



**Ignition for Gas Burners**



**Flame Failure Device for Gas Burners**



**Semi Flat Burner**

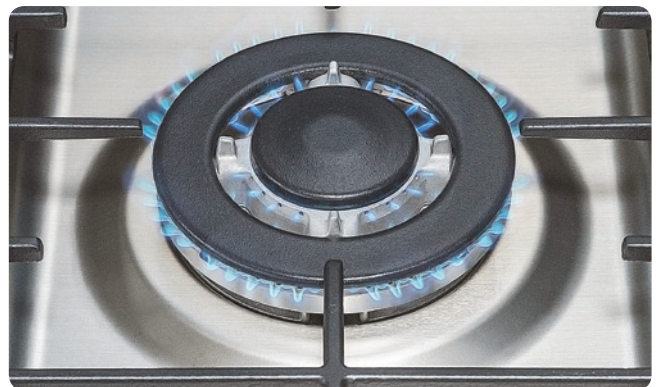

**Wok Burner**



**Semi Flat Wok Burner**



**High Efficiency Wok Burner** *for 90cm gas on glass hobs*



Enamel Wok Adapter



Cast Iron Wok Adapter



Cast Iron Wok Adapter  
*for High Efficiency Wok Burner  
only 90cm gas on glass hob*



Button Ignition for Gas Hobs



Button Ignition for Gas Hobs *only smoothline aesthetic*



Main Valve Button *for 90 cm gas on glass hob*



Rapid Solid Hotplate



Mechanical Timer *for domino hobs*

## Built-In / Table-Top Hobs

60cm      70cm      90cm

Flat / Surface      Model I

Extenda      Plus X

Classic

Model I

PlusX

Division

Model I

PlusX

Securit II

Trio

Model I

PlusX

Division

### Hob Features

Hotplate Operation Indicator Light	Hot Surface Indicator Light
Side Knob Control	Hotplate Operation Indicator Light
Front Knob Control	Side Knob Control
Double Side Front Control	Front Knob Control
Logo	Double Side Front Control
Table Top Installation (not built-in)	Front Triangular Touch Control
Glass Lid	Front Slider Touch Control
Burner Safety Valves	Front Touch Control
Button Ignition	Bevelled Edges
One-touch-Ignition through knobs	Logo
Enamel Pan Supports	Special Decoration on Glass
Cast Iron Pan Supports	Vitroceraic Glass Artwork
Cast Iron Burner Caps	Inox Frame
Coffee Adaptor	Vitroceraic Glass Cleaning Spatula
Wok Adaptor	Gas Conversion Kit
Vitroceraic Glass Cleaning Spatula	Others
Gas Conversion Kit	Total Gas Power (Depends on Model) Maximum
RoHS Compliance	Total Electric Power (Depends on Model) Maximum
CE Compliance	Voltage
Carton Box Packaging	RoHS Compliance
Timer function for vitro ceramic hobs (If touch control with some hob Configuration selected)	CE Compliance
Mode function for induction ceramic hobs (If touch control with some hob Configuration selected)	Carton Box Packaging
Bridge zone for induction ceramic hobs (If touch control with some hob Configuration selected)	Packed Product Dimensions (WxDxH)
Child Lock for vitro ceramic hobs (If touch control selected)	Packed Product Dimensions (WxDxH) Box
Mechanical Child Lock (Main Switch)	Net Weight (Depends on Model) Maximum
	Gross Weight (Depends on Model) Maximum



## SMART PLUS

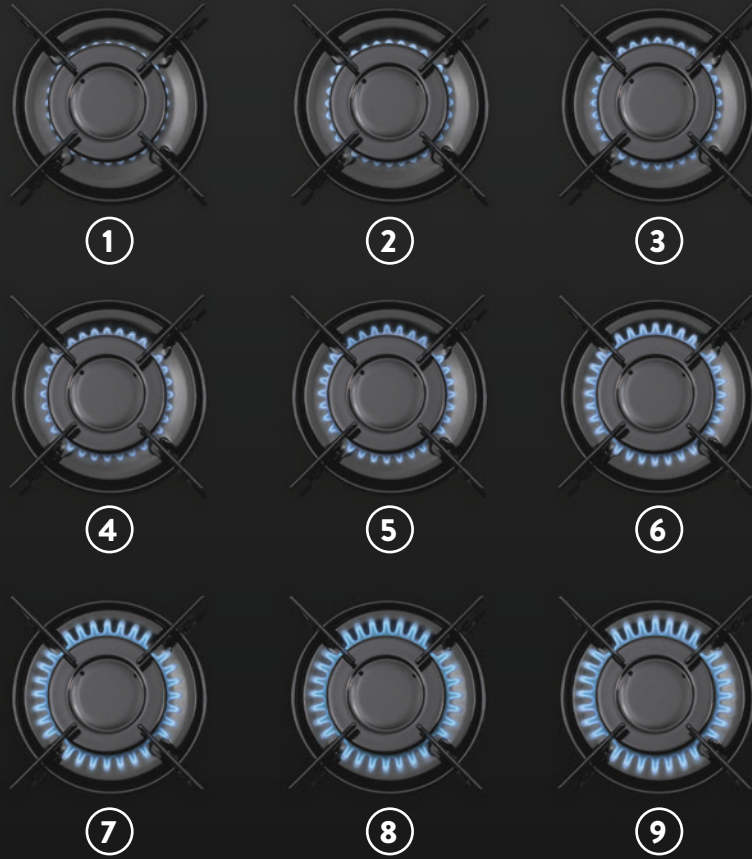

**Nine step flame control with Semi Flat Burners and extended glass on gas hob**

**More wide surface**  
25 mm extra cooking area

**More precise control**  
9 step control

**More efficient and faster cooking**  
20 percent higher efficient





## **B G O G H . 4 8**

### ***Standard Features***

- 65 cm gas on glass hob
- 9 step flame control
- 4 gas burners
- Semi flat burners
- Side knob control
- Flame safety device
- Mat enamel burner pans
- One touch ignition
- Cast iron burner caps
- Cast iron pan supports

### ***Optional Features***

- Metal clad knobs





### Down-Air Induction Hob

78 cm induction hob with integrated extractor  
 4 speed, min 54dB(A) - max 71dB(A)  
 Timer (15min automatic overrun)  
 Dishwasher safe metal air filter

### Free Air Induction Hob

Independent extractor with 2 domino hobs  
 4 speed, min 55dB(A) - max 68dB(A)  
 Dishwasher safe metal air filter

## VIFTC-DA.01

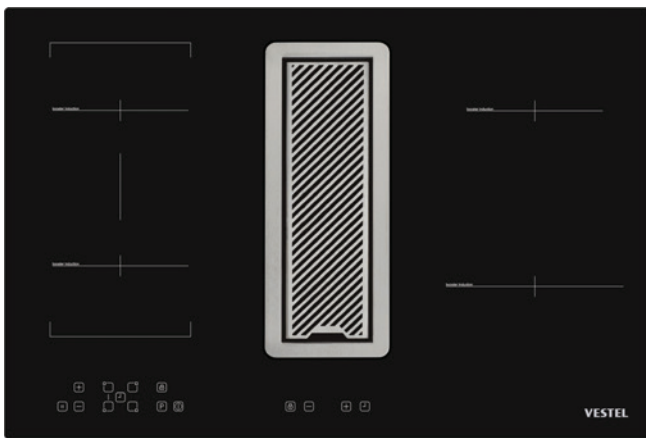

### Features

78 cm induction ceramic hob  
 Front touch control  
 Down-Air  
 3 Ø 160 mm 1400 W / Boost 1800 W induction element  
 1 Ø 200 mm 2100 W / Boost 2500 W induction element  
 Booster Function

Hot surface indicator  
 Pot Detection  
 Child lock  
 Key lock  
 Smart pause

## DIHS1-FA.01

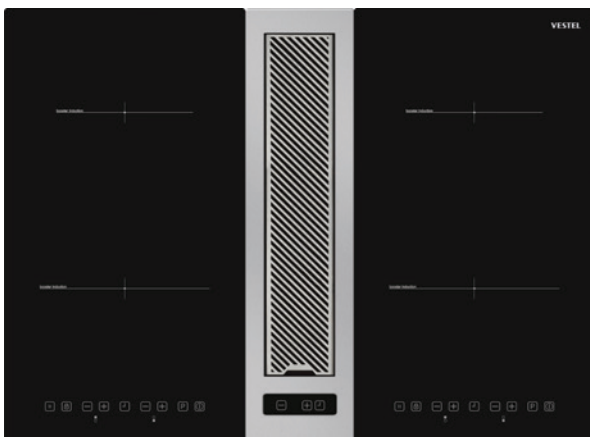

### Features

2x30 cm induction ceramic hob  
 Front touch control  
 Free Air  
 2 Ø 160 mm 1400 W / Boost 1800 W induction element  
 2 Ø 200 mm 2100 W / Boost 2500 W induction element  
 Booster Function

Hot surface indicator  
 Pot Detection  
 Child lock  
 Key lock  
 Smart pause  
 Timer



# V-FLEX INDUCTION HOB

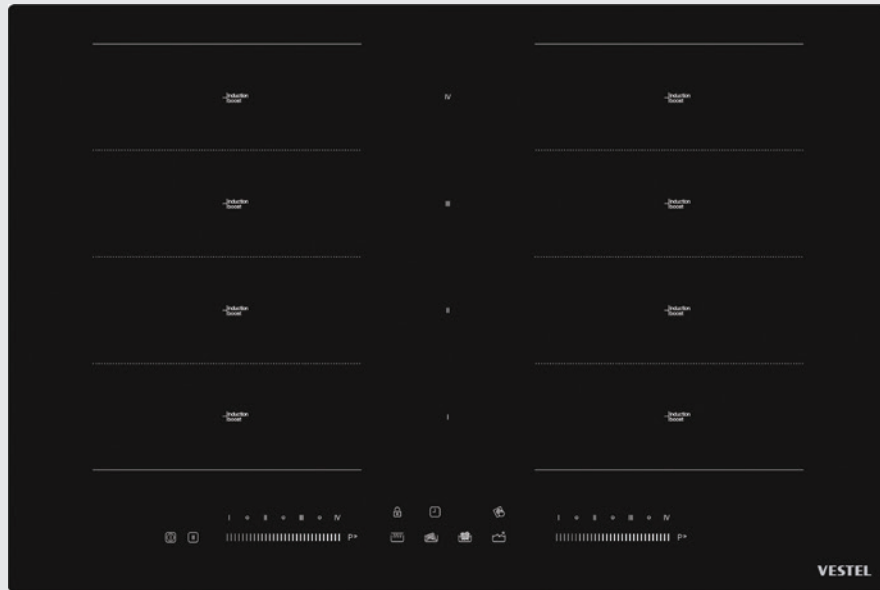

78 cm induction ceramic hob

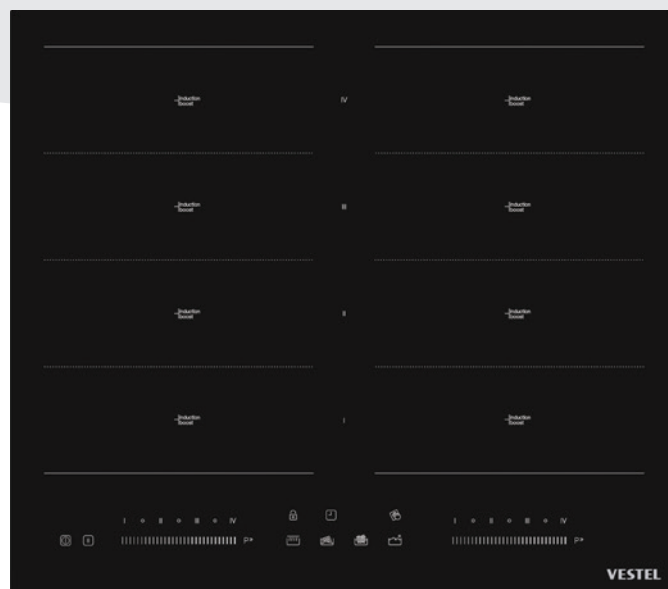

60 cm induction ceramic hob

- Slider touch control
- 2 V-Flex induction zone
- 8x 900 W / Boost 1200 W induction element
- Auto zone selection
- Booster Function
- Hot surface indicator
- Pot Detection
- Child lock
- Key lock
- Smart pause



## VIFTC.16

### Standard Features

90 cm induction ceramic hob  
 Front touch control  
 Booster function  
 2 Ø 160 mm 1400 W /  
 Boost 1800 W induction  
 element  
 2 Ø 200 mm 2100 W /  
 Boost 2500 W induction  
 element 1Ø250mm2800W/  
 Boost  
 3500 W induction element  
 Pot detection

Child lock  
 Hot surface indicator  
 Timer  
 Slim design ceran glass  
 serigraphy  
 Key Lock Smart Pause

### Optional Features

Two side inox frame

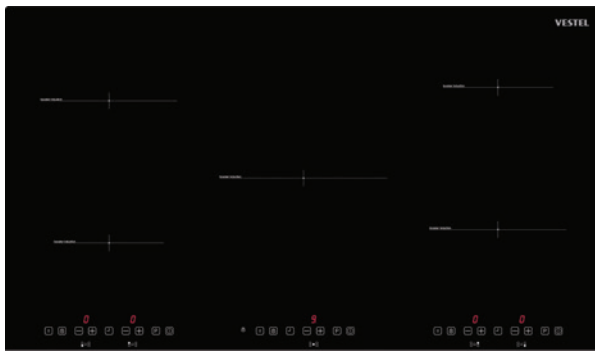

## VIFTC.19

### Standard Features

90 cm induction ceramic hob  
 Front touch control  
 Booster function  
 2 Ø 160 mm 1400 W /  
 Boost 1800 W induction  
 element  
 2 Ø 200 mm 2100 W /  
 Boost 2500 W induction  
 element  
 1 Ø 250 mm 2800 W /  
 Boost 3500 W induction  
 element  
 Pot detection

Child lock  
 Hot surface indicator  
 Timer  
 Key Lock  
 Smart Pause

### Optional Features

Front side bevelled edge  
 glass

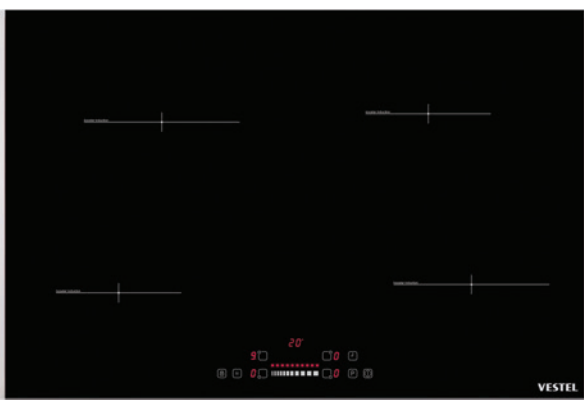

## VIFTC.01

### Standard Features

78 cm induction ceramic hob  
 Booster function  
 2 Ø 160 mm 1400 W /  
 Boost 1800 W induction  
 element  
 2 Ø 200 mm 2100 W /  
 Boost 2500 W induction  
 element  
 Pot detection  
 Key lock  
 Child lock

Hot surface indicator  
 Smart Pause

### Optional Features

Slider touch control  
 Two side inox frame Front  
 side bevelled edge glass  
 Mode function  
 Timer



## VIFTC.24

### Standard Features

90 cm induction ceramic hob  
 Slider touch control  
 Booster function  
 4 Ø 160 mm 1400 W /  
 Boost 1800 W induction  
 element  
 1 Ø 250 mm 2800  
 W / Boost 3500 W  
 induction element  
 Pot detection  
 Child lock

Hot surface indicator  
 Timer  
 Key Lock  
 Smart Pause

### Optional Features

Two Bridge Zones



## VIFTC.25

### Standard Features

90 cm induction ceramic hob  
 Slider touch control  
 Booster function  
 3 Ø 160 mm 1400 W /  
 Boost 1800 W induction  
 element  
 1 Ø 200 mm 2100  
 W / Boost 2500 W  
 induction element  
 1 Ø 250 mm 2800  
 W / Boost 3500 W  
 induction element

Pot detection  
 Child lock  
 Hot surface indicator  
 Timer  
 Key Lock  
 Smart Pause

### Optional Features

Bridge Zone

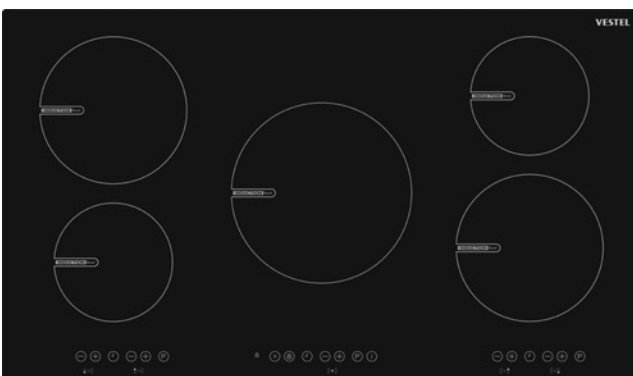

## VIFTC.26

### Features

90 cm induction ceramic hob  
 Front touch control  
 Single On/Off button  
 Booster function  
 2 Ø 160 mm 1400 W /  
 Boost 1800 W induction  
 element  
 2 Ø 200 mm 2100  
 W / Boost 2500 W  
 induction element  
 1 Ø 250 mm 2800

W / Boost 3500 W  
 induction element  
 Pot detection  
 Child lock  
 Hot surface indicator  
 Timer  
 Key Lock  
 Smart Pause



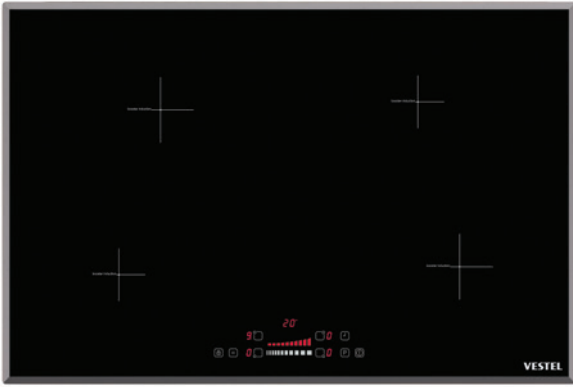

## VIFTC.02

### Standard Features

78 cm induction ceramic hob  
 Booster function  
 2 Ø 160 mm 1400 W /  
 Boost 1800 W induction  
 element  
 2 Ø 200 mm 2100 W /  
 Boost 2500 W induction  
 element  
 Pot detection  
 Key lock  
 Child lock

Hot surface indicator  
 Smart Pause  
 Timer

### Optional Features

Slider touch control  
 Front side bevel  
 Mode function

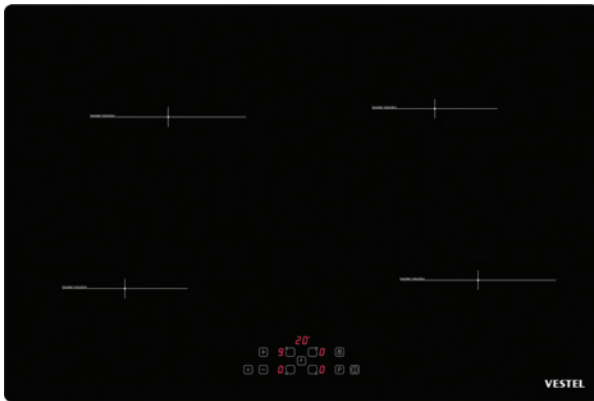

## VIFTC.05

### Standard Features

78 cm induction ceramic hob  
 Front touch control  
 Booster function  
 2 Ø 160 mm 1400 W /  
 Boost 1800 W induction  
 element  
 2 Ø 200 mm 2100 W /  
 Boost 2500 W induction  
 element  
 Pot detection  
 Key lock  
 Child lock

Hot surface indicator  
 Smart Pause

### Optional Features

Timer

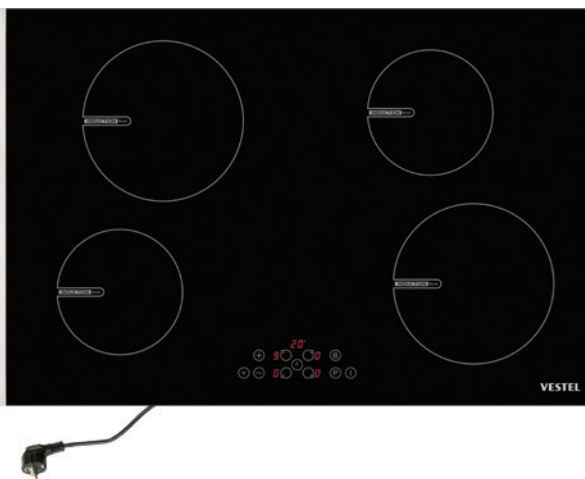

## VIFTC.06

### Standard Features

78 cm induction ceramic hob  
 Front touch control  
 Booster function  
 2 Ø 160 mm 1400 W /  
 Boost 1800 W induction  
 element  
 2 Ø 200 mm 2100 W /  
 Boost 2500 W induction  
 element  
 Pot detection

Key lock  
 Child lock  
 Hot surface indicator  
 Smart Pause  
 Timer

### Optional Features

Two side inox frame  
 Mode function  
 Plug and Play

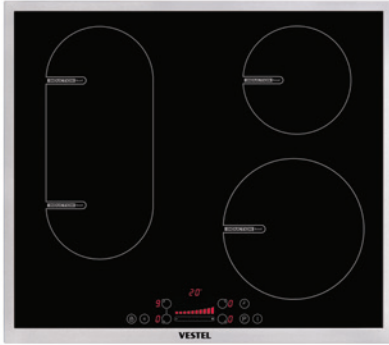

## VIFTC.18

### Standard Features

60 cm induction ceramic hob  
 Booster function  
 3 Ø 160 mm 1400 W / Boost  
 1800 W induction element  
 1 Ø 210 mm 2100 W / Boost  
 2500 W induction element  
 Pot Detection  
 Child lock  
 Hot surface indicator  
 Key lock  
 Smart pause  
 Timer

### Optional Features

Slider touch control  
 Full inox frame  
 Bridge zone  
 Mode function



## VIFTC.08

### Standard Features

60 cm induction ceramic hob  
 Booster function  
 2 Ø 160 mm 1400 W / Boost  
 1800 W induction element  
 2 Ø 210 mm 2100 W / Boost  
 2500 W induction element  
 Pot detection  
 Key lock  
 Child lock  
 Hot surface indicator  
 Smart Pause  
 Timer

### Optional Features

Slider touch control  
 Two side inox frame  
 Mode function

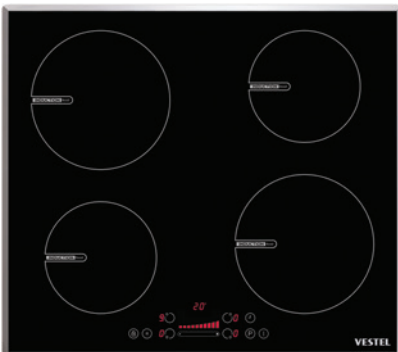

## VIFTC.09

### Standard Features

60 cm induction ceramic hob  
 Booster function  
 2 Ø 160 mm 1400 W / Boost  
 1800 W induction element  
 2 Ø 210 mm 2100 W / Boost  
 2500 W induction element  
 Pot detection  
 Key lock  
 Child lock  
 Hot surface indicator  
 Smart Pause  
 Timer

### Optional Features

Slider touch control  
 Bevelled edge glass  
 Mode function



## VIFTC.21

### Standard Features

60 cm induction ceramic hob  
 Front touch control  
 Booster function  
 4 Ø 160 mm 1400 W / Boost  
 1800 W induction element  
 Pot Detection  
 Child lock  
 Hot surface indicator  
 Key lock  
 Smart pause

### Optional Features

Timer  
 Full inox frame  
 Two Bridge Zones  
 Mode function



## VIFTC.12

### Standard Features

60 cm induction ceramic hob  
 Front touch control  
 Booster function  
 2 Ø 160 mm 1400 W / Boost  
 1800 W induction element  
 2 Ø 210 mm 2100 W / Boost  
 2500 W induction element  
 Pot detection  
 Key lock  
 Child lock  
 Hot surface indicator  
 Smart Pause

### Optional Features

Inox frame

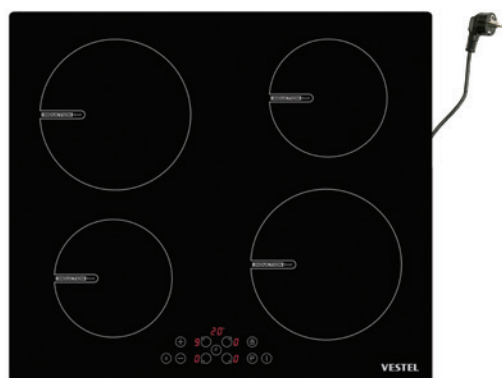

## VIFTC.13

### Standard Features

60 cm induction ceramic hob  
 Front touch control  
 Booster function  
 2 Ø 160 mm 1400 W / Boost  
 1800 W induction element  
 2 Ø 210 mm 2100 W / Boost  
 2500 W induction element  
 Pot detection  
 Key lock  
 Child lock

Hot surface indicator  
 Smart Pause

### Optional Features

Timer  
 Mode function  
 Plug and Play



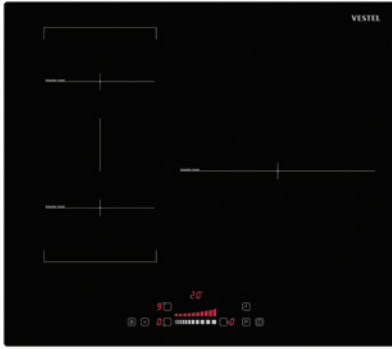

## VIFTC.20

### Standard Features

60 cm induction ceramic hob  
 Booster function  
 2 Ø 160 mm 1400 W / Boost  
 1800 W induction element  
 1 Ø 210 mm 2100 W / Boost  
 2500 W induction element  
 Pot Detection  
 Child lock  
 Hot surface indicator  
 Key lock  
 Smart pause  
 Timer

### Optional Features

Slider touch control  
 Birdge zone  
 Mode function

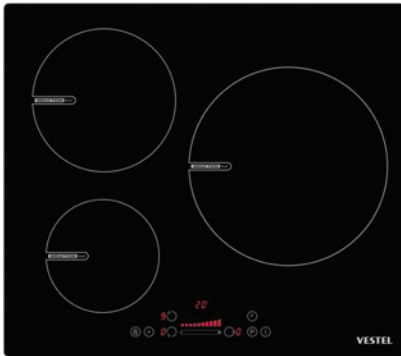

## VIFTC.10

### Standard Features

60 cm induction ceramic hob  
 Booster function  
 1 Ø 160 mm 1400 W / Boost  
 1800 W induction element  
 1 Ø 210 mm 2100 W / Boost  
 2500 W induction element  
 1 Ø 290 mm 2800 W / Boost  
 3500 W induction element  
 Pot detection  
 Key lock  
 Child lock  
 Hot surface indicator  
 Smart Pause

### Optional Features

Slider touch control  
 Timer

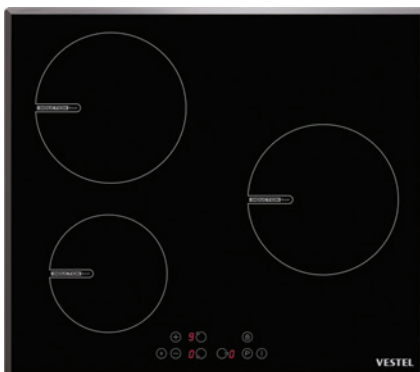

## VIFTC.14

### Standard Features

60 cm induction ceramic hob  
 Front touch control  
 Booster function  
 1 Ø 160 mm 1400 W / Boost  
 1800 W induction element  
 2 Ø 210 mm 2100 W / Boost  
 2500 W induction element  
 Pot detection  
 Key lock  
 Child lock  
 Hot surface indicator  
 Smart Pause

### Optional Features

Bevelled edge glass

## VFTC.01

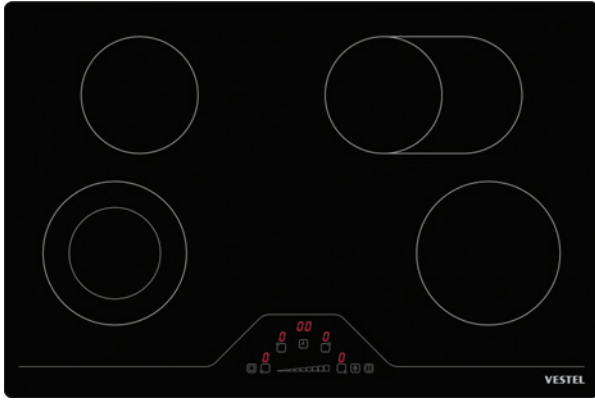

### Standard Features

78 cm ceramic hob  
1 Ø 145 mm Highlight Element 1200W  
1 Ø 180 mm Highlight Element 1800W  
Child lock  
Hot surface indicator  
Key Lock

### Optional Features

Slider touch control  
Ø 145 mm Oval Highlight Element 1000W/1800W  
Ø 180 mm Dual Highlight Element 700W/1700W  
Smart pause (with slider)  
Timer

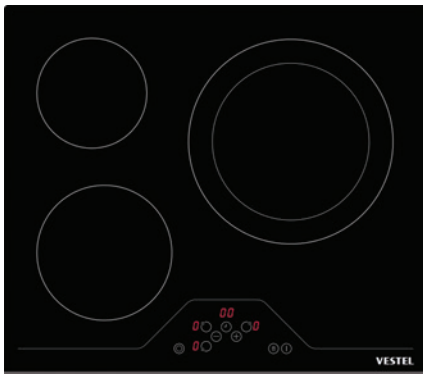

### Standard Features

60 cm ceramic hob  
Front touch control  
Ø 145 mm Highlight Element 1200W  
Ø 180 mm Highlight Element 1800W  
Child lock  
Hot surface indicator  
Key Lock

### Optional Features

Ø 290 mm Dual Highlight Element 1800W/2700W  
Timer  
Front side bevelled edge glass  
Slider touch control

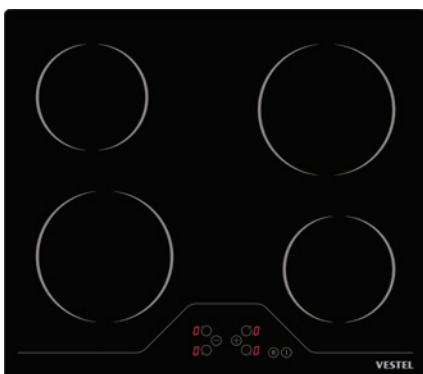

## VFTC.12

### Features

60 cm ceramic hob  
Front touch control  
2 Ø 145 mm Highlight Element 1200W  
2 Ø 180 mm Highlight Element 1800W  
Child lock  
Hot surface indicator  
Key Lock

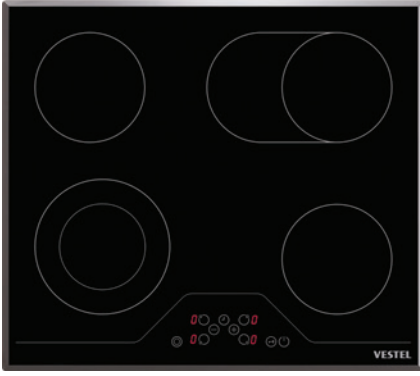

## VFTC.04

### Standard Features

60 cm ceramic hob  
 2 Ø 145 mm Highlight  
 Element 1200W  
 Child lock  
 Hot surface indicator  
 Key Lock  
 Front touch control

### Optional Features

Ø 180 mm Dual Highlight  
 Element 700W/1700W  
 Ø 145 mm Oval Highlight  
 Element 1000W/1800W  
 Timer  
 Bevelled edge glass

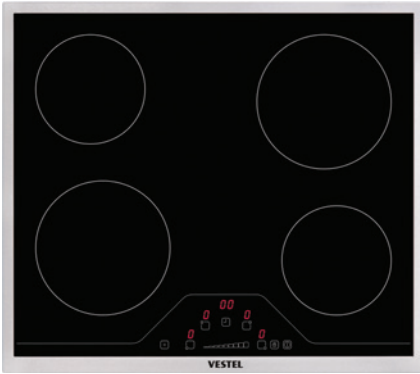

## VFTC.06

### Standard Features

60 cm ceramic hob  
 2 Ø 145 mm Highlight  
 Element 1200W 2  
 Ø 180 mm Highlight Element  
 1800W  
 Child Lock  
 Hot surface indicator  
 Slim design ceran glass  
 serigraphy  
 Key Lock

### Optional Features

Slider touch control  
 Timer  
 Full inox frame  
 Smart pause (with slider)

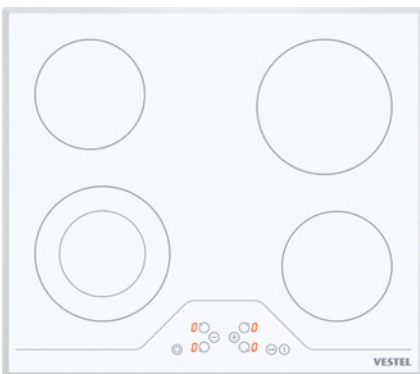

## VFTC.08

### Standard Features

60 cm ceramic hob  
 Front touch control  
 2 Ø 145 mm Highlight  
 Element 1200W Ø 180 mm  
 Highlight Element 1800W  
 Child lock  
 Hot surface indicator  
 Key Lock

### Optional Features

Ø 180 mm Dual Highlight  
 Element 700W/1700W  
 Bevelled edge glass  
 White ceramic glass  
 Timer



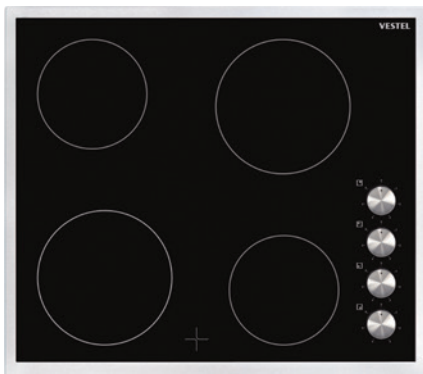

## V K C . 0 7

### Standard Features

60 cm ceramic hob  
 Side knob control  
 2 Ø 145 mm Highlight Element 1200W  
 2 Ø 180 mm Highlight Element 1800W  
 Hot surface indicator light  
 Slim design ceran glass serigraphy

### Optional Features

Full inox frame  
 Metal clad knob

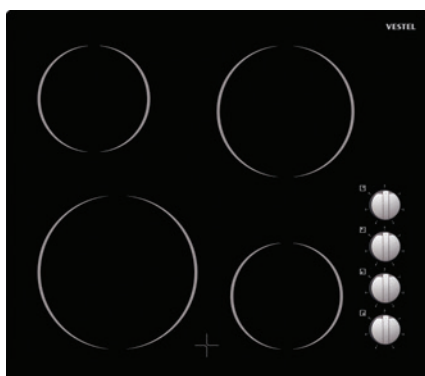

## V K C . 0 2

### Standard Features

60 cm ceramic hob  
 Side knob control  
 2 Ø 145 mm Highlight Element 1200W  
 Ø 180 mm Highlight Element 1800W  
 Hot surface indicator light

### Optional Features

Ø 210 mm Highlight Element 2300W  
 Inox painted knobs

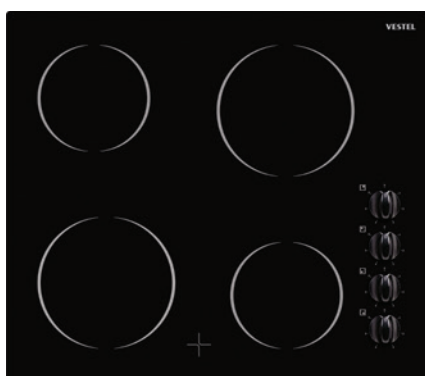

## V K C . 0 6

### Features

60 cm ceramic hob  
 Side knob control  
 2 Ø 145 mm Highlight Element 1200W  
 2 Ø 180 mm Highlight Element 1800W  
 Hot surface indicator light

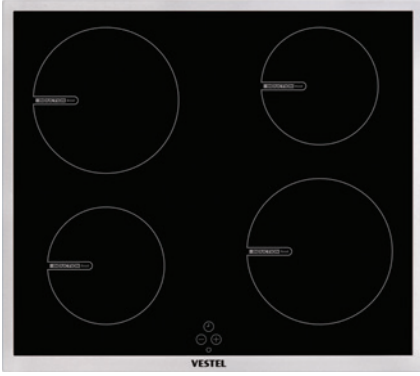

## VICH.01

### Standard Features

60 cm induction ceramic hob  
 Combination with oven  
 Knob controlled from oven  
 Booster function  
 2 Ø 160 mm 1400 W / Boost  
 1800 W induction element  
 2 Ø 200 mm 2100 W / Boost  
 2500 W induction element  
 Pot detection  
 Child lock  
 Hot surface indicator

### Optional Features

Timer  
 Slim design ceran glass  
 serigraphy

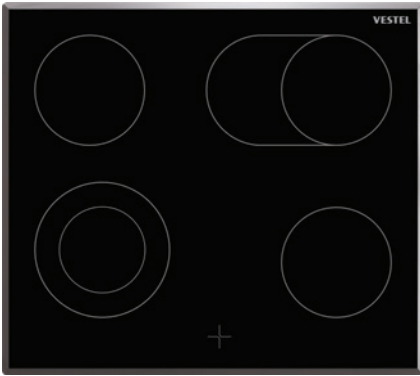

## VCH.02

### Standard Features

60 cm ceramic hob  
 Combination with oven  
 2 Ø 145 mm Highlight  
 Element 1200W  
 Hot surface indicator light

### Optional Features

Ø 180 mm Dual Highlight  
 Element 700W/1700W  
 Ø 145 mm Oval Highlight  
 Element 1000W/1800W  
 Bevelled edge glass

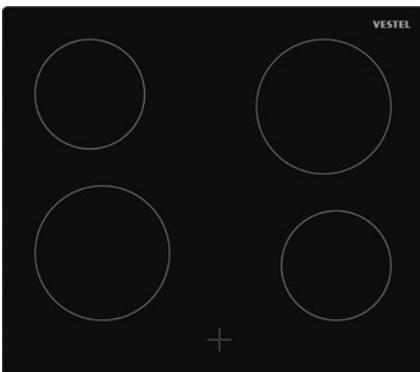

## VICH.03

### Standard Features

60 cm ceramic hob  
 Combination with oven  
 2 Ø 145 mm Highlight  
 Element 1200W  
 2 Ø 180 mm Highlight  
 Element 1800W  
 Hot surface indicator light



## BGOGH.44

### Standard Features

90 cm gas on glass hob  
 5 gas burners  
 High efficiency wok burner  
 Front knob control  
 Flame safety device  
 Cast iron pan supports  
 Cast iron burner caps  
 Mat enamel burner pans  
 One touch ignition

### Optional Features

Metal clad knobs  
 Main switch

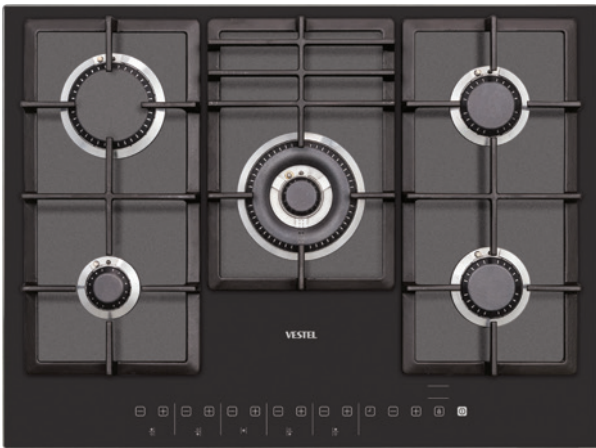

## BGOGH.45

### Features

70 cm gas on glass hob  
 5 gas burners  
 Semi flat burners  
 Wok burner  
 Front touch control  
 Flame safety device  
 Mat enamel burner pans  
 Cast iron burner caps  
 Cast iron pan supports  
 Timer



## BGOGH.46

### Standard Features

70 cm gas on glass hob  
 5 gas burners  
 Semi flat burners  
 Wok burner  
 Front knob control  
 Flame safety device  
 Mat enamel burner pans  
 One touch ignition  
 Cast iron burner caps  
 Cast iron pan supports

### Optional Features

Metal clad knobs



## B G O G H . 1 7

### Standard Features

70 cm gas on glass hob  
 Plus X Design  
 5 gas burners  
 Wok burner  
 Front knob control  
 Flame safety device

### Optional Features

Mat enamel burner pans  
 Mat enamel burner caps  
 Cast iron pan supports  
 Metal clad knobs  
 One touch ignition



## B G O G H . 2 8

### Standard Features

70 cm gas on glass hob  
 Plus X Design  
 5 gas burners  
 Wok burner  
 Front knob control  
 Flame safety device

### Optional Features

Mat enamel burner pans  
 Mat enamel burner caps  
 Cast iron pan supports  
 Metal clad knobs  
 One touch ignition



## B G O G H . 4 7

### Standard Features

70 cm gas on glass hob  
 Plus X Design  
 5 gas burners  
 Wok burner  
 Front knob control  
 Flame safety device  
 Enamel burner pans  
 Enamel burner caps  
 Enamel pan supports

### Optional Features

Metal clad knobs  
 One touch ignition  
 PlusX design pan supports





## B G O G H . 2 9

### Standard Features

70 cm gas on glass hob  
 Plus X Design  
 5 gas burners  
 Wok burner  
 Front knob control  
 Flame safety device

### Optional Features

White optical glass  
 Inox burner pans  
 Mat enamel burner caps  
 Cast iron pan supports  
 (line design)  
 Metal clad knobs  
 One touch ignition



## B G O G H . 3 1

### Standard Features

70 cm gas on glass hob  
 Plus X Design  
 5 gas burners  
 Wok burner  
 Front knob control  
 Flame safety device

### Optional Features

Mat enamel burner pans  
 Cast iron burner caps  
 Cast iron pan supports  
 (deluxe design)  
 Metal clad knobs  
 One touch ignition

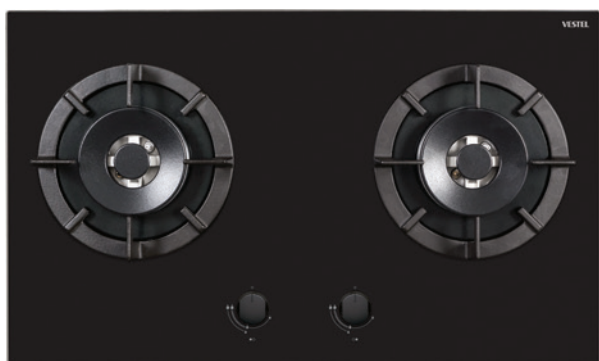

## B G O G H . 5 2

### Standard Features

75 cm gas on glass hob  
 2 gas burners  
 3,6 kW wok burner  
 Front knob control  
 Flame safety device  
 Mat enamel burner pans  
 Cast iron burner caps  
 Cast iron pan supports  
 One touch ignition



## BGOGH.20

### Standard Features

60 cm gas on glass hob  
 Plus X Design  
 4 gas burners  
 Front knob control  
 Flame safety device

### Optional Features

Mat enamel burner pans  
 Mat enamel burner caps  
 Cast iron pan supports (line design)  
 Metal clad knobs  
 One touch ignition



## BGOGH.32

### Standard Features

60 cm gas on glass hob  
 Plus X Design  
 4 gas burners  
 Front knob control  
 Flame safety device

### Optional Features

Wok burner  
 Mat enamel burner pans  
 Mat enamel burner caps  
 Cast iron pan supports (line design)  
 Metal clad knobs  
 One touch ignition



## BGOGH.36

### Standard Features

60 cm gas on glass hob  
 Plus X Design  
 4 gas burners  
 Front knob control  
 Flame safety device

### Optional Features

White optical glass  
 Inox burner pans  
 Mat enamel burner caps  
 Cast iron pan supports  
 Metal clad knobs  
 One touch ignition



## B G O G H . 5 0

### Standard Features

60 cm gas on glass hob  
 Plus X Design  
 4 gas burners  
 Wok burner  
 Front knob control  
 Flame safety device  
 Enamel burner pans  
 Enamel burner caps  
 Enamel pan supports

### Optional Features

White optical glass  
 Metal clad knobs  
 One touch ignition  
 PlusX design pan supports



## B G O G H . 3 4

### Standard Features

60 cm gas on glass hob  
 Plus X Design  
 4 gas burners  
 Front knob control  
 Flame safety device

### Optional Features

Mirror glass  
 Wok burner  
 Inox burner pans  
 Mat enamel burner caps  
 Cast iron pan supports  
 (deluxe design)  
 Metal clad knobs  
 One touch ignition

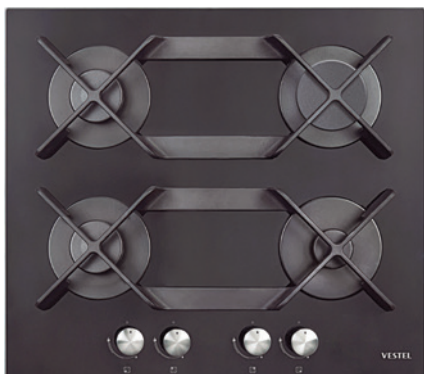

## B G O G H . 1 9

### Standard Features

60 cm gas on glass hob  
 Plus X Design  
 4 gas burners  
 Front knob control  
 Flame safety device

### Optional Features

Mat enamel burner pans  
 Cast iron burner caps  
 Cast iron pan supports  
 Metal clad knobs  
 One touch ignition



## B G O G H . 1 8

### Standard Features

60 cm gas on glass hob  
 Plus X Design  
 Front knob control  
 Flame safety device  
 Enamel burner pans  
 Enamel burner caps  
 Enamel pan supports

### Optional Features

Metal clad knobs  
 One touch ignition  
 3 gas burners and 145 mm hotplate

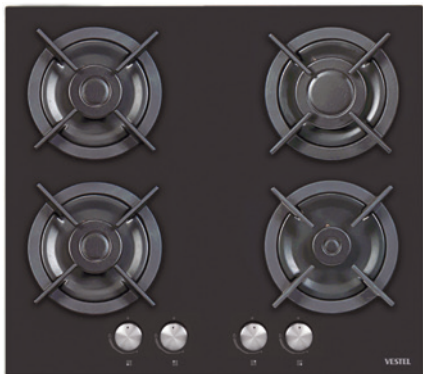

## B G O G H . 2 1

### Standard Features

60 cm gas on glass hob  
 Plus X Design  
 4 gas burners  
 Front knob control  
 Flame safety device

### Optional Features

Mat enamel burner pans  
 Mat enamel burner caps  
 Cast iron pan supports  
 Metal clad knobs  
 One touch ignition

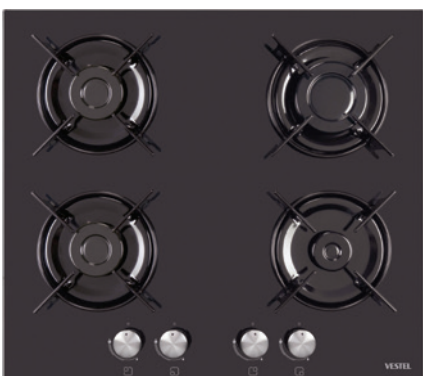

## B G O G H . 4 9

### Standard Features

60 cm gas on glass hob  
 Plus X Design  
 4 gas burners  
 Front knob control  
 Flame safety device  
 Enamel burner pans  
 Enamel burner caps  
 Enamel pan supports

### Optional Features

Metal clad knobs  
 One touch ignition  
 PlusX design pan supports





## BGOGH.24

### Standard Features

60 cm gas on glass and induction hob  
 Pure Design  
 Side knob control and Side touch control  
 2 gas burners  
 Enamel burner pans, pan supports and burner caps  
 Flame safety device  
 Booster function  
 Ø 160 mm 1400 W / Boost 1800 W induction element

Ø 200 mm 2100 W / Boost 2500 W induction element  
 Pot detection  
 Automatic heat up  
 Child lock  
 Hot surface indicator  
 Key Lock  
 Timer

### Optional Features

Metal clad knobs  
 One touch ignition



## BGOGH.38

### Standard Features

60 cm gas on glass and induction hob  
 Pure design  
 Side knob control and side touch control  
 2 gas burners - Flame safety device Ø 160 mm 1400 W / Boost 1800 W induction element  
 Ø 200 mm 2100 W / Boost 2500 W induction element  
 Pot detection  
 Child lock

Hot surface indicator  
 Touch control interface for induction zones  
 Key Lock  
 Timer

### Optional Features

Mat enamel burner pans and caps  
 Cast iron pan supports  
 Metal clad knobs  
 Full inox frame  
 One touch ignition



## BGOGH.48

### Standard Features

60 cm gas on glass hob  
 4 gas burners  
 Semi flat burners  
 Side knob control  
 Flame safety device  
 Mat enamel burner pans  
 One touch ignition  
 Cast iron burner caps  
 Cast iron pan supports

### Optional Features

Metal clad knobs  
 Wok burner



## BGOGH.39

### Standard Features

60 cm gas on glass and vitroceramic hob  
 Pure design  
 Side knob control  
 3 gas burners  
 Flame safety device  
 Ø 180 mm Dual Highlight Element 700 W / 1700W  
 Hot surface indicator  
 One touch ignition

### Optional Features

Mat enamel burner pans and caps  
 Cast iron pan supports  
 Metal clad knobs  
 Full inox frame



## BGOGH.25

### Standard Features

60cm gas on glass and vitroceramic hob  
 Pure design  
 Side knob control  
 2 gas burners  
 Flame safety device  
 Ø 145 mm Highlight Element 1200W  
 Ø 180 mm Highlight Element 1800W  
 Hot surface indicator  
 One touch ignition

### Optional Features

Mat enamel burner pans  
 Mat enamel burner caps  
 Cast iron pan supports  
 Metal clad knobs



## BGOGH.05

### Standard Features

60 cm gas on glass hob  
 4 gas burners  
 Side knob control  
 Black Glass  
 Enamel burner pans  
 Flame safety device

### Optional Features

Wok burner  
 Cast iron burner caps  
 Cast iron pan supports  
 One touch ignition



## B G O G H . 4 3

### Standard Features

60 cm gas on glass hob  
 Division design  
 4 gas burners  
 Front knob control  
 Flame safety device  
 Cast iron pan supports  
 Enamel burner caps  
 Enamel burner caps

### Optional Features

Metal clad knobs  
 One touch ignition



## B G O G H . 4 1

### Standard Features

60 cm gas on glass hob  
 3 gas burners  
 Wok burner  
 Side knob control  
 Flame safety device

### Optional Features

Mat enamel burner pans  
 Mat enamel burner caps  
 Mat enamel pan supports  
 One touch ignition



## B G O G H . 1 1

### Standard Features

60 cm gas on glass hob 4 gas  
 burners  
 Side knob control  
 Enamel burner caps  
 Enamel pan supports  
 Flame safety device  
 Enamel burner pans

### Optional Features

Mink colored optical glass  
 Black painted knobs  
 One touch ignition



## B G O G H . 5 3

### Standard Features

60 cm gas on glass hob  
4 gas burners  
Side knob control  
Cast iron burner caps  
Cast iron pan supports  
Flame safety device

### Optional Features

Mat enamel burner pans  
Dark gray optical glass  
Metal clad knobs  
One touch ignition



## B G O G H . 2 6

### Standard Features

60 cm gas on glass hob  
4 gas burners  
Side knob control  
Flame safety device

### Optional Features

Mat enamel burner caps  
Mat enamel pan supports  
Mat enamel burner pans  
White optical glass  
One touch ignition



## B G O G H . 0 1

### Standard Features

60 cm gas on glass hob  
4 gas burners  
Side knob control  
Enamel burner caps  
Enamel pan supports  
Enamel burner pans  
Flame safety device

### Optional Features

Metal clad knobs  
One touch ignition





## B G O G H . 2 7 Rustic

### Standard Features

60 cm gas on glass hob  
4 gas burners  
Side knob control  
Flame safety device  
Enamel burner caps  
Enamel pan supports  
Enamel burner pans

### Optional Features

Type-C Rustic design black optical glass  
One touch ignition  
Flame safety device  
Special rustic knobs



## B G O G H . 1 2 Rustic

### Standard Features

60 cm gas on glass hob  
4 gas burners  
Side knob control  
Flame safety device  
Enamel burner caps  
Enamel pan supports  
Enamel burner pans

### Optional Features

Type-C Rustic design cream optical glass  
One touch ignition  
Flame safety device  
Special rustic knobs



## B G O G H . 1 5 Rustic

### Standard Features

60 cm gas on glass hob  
4 gas burners  
Side knob control  
Flame safety device  
Enamel burner caps  
Enamel pan supports  
Enamel burner pans

### Optional Features

Type-B Rustic design white optical glass  
One touch ignition  
Flame safety device  
Special rustic knobs



## B G H . 4 4

### Standard Features

70 cm gas hob Plus X Design  
5 gas burners  
Wok burner  
Front knob control Flame safety device

### Optional Features

Stainless steel  
Glass control panel  
Cast iron burner caps  
Cast iron pan supports  
Metal clad knobs  
One touch ignition



## B G H . 4 5

### Standard Features

70 cm gas hob Plus X Design  
5 gas burners  
Wok burner  
Front knob control  
Enamel pan supports  
Enamel burner pans  
Flame safety device

### Optional Features

Stainless steel  
Inox painted knobs  
One touch ignition



## B G H . 4 6

### Standard Features

70 cm gas hob Plus X Design  
5 gas burners  
Wok burner  
Front knob control  
Flame safety device

### Optional Features

Stainless steel  
Cast iron burner caps  
Cast iron pan supports  
Inox painted knobs  
One touch ignition



#### *Standard Features*

60 cm gas hob  
Plus X Design  
4 gas burners  
Front knob control  
Flame safety device

### **B G H . 4 7**

#### *Optional Features*

Stainless steel  
Wok burner  
Mat enamel burner caps  
Cast iron pan supports  
Glass control panel  
Metal clad knobs  
One touch ignition



#### *Standard Features*

60 cm gas hob  
Plus X Design  
4 gas burners  
Front knob control  
Enamel pan supports  
Enamel burner pans  
Flame safety device

### **B G H . 5 7**

#### *Optional Features*

Metal clad knobs  
Black enamel hob  
One touch ignition



#### *Standard Features*

40 cm gas hob  
Plus X Design  
4 gas burners  
Front knob control  
Flame safety device

### **B G H . 4 8**

#### *Optional Features*

Stainless steel  
Cast iron burner caps  
Cast iron pan supports  
Glass control panel  
Metal clad knobs  
One touch ignition



## **B G H . 5 0**

### **Standard Features**

60 cm gas hob  
Plus X Design  
4 gas burners  
Front knob control  
Enamel pan supports  
Enamel burner pans  
Flame safety device

### **Optional Features**

Metal clad knobs  
One touch ignition



## **B G H . 5 1**

### **Standard Features**

60 cm gas hob  
Plus X Design  
4 gas burners  
Front knob control  
Enamel pan supports  
Enamel burner caps  
Flame safety device

### **Optional Features**

Stainless steel  
Inox painted knobs  
One touch ignition



## **B G H . 5 2**

### **Standard Features**

60 cm gas hob  
Division design  
4 gas burners  
Front knob control  
Flame safety device  
Cast iron pan supports  
Mat enamel burner caps  
Stainless steel hob

### **Optional Features**

Metal clad knobs  
One touch ignition





## B G H . 2 9

### Standard Features

- 60 cm gas hob
- Surface design
- 4 gas burners
- Side knob control
- Enamel pan supports
- Enamel burner caps
- Flame safety device

### Optional Features

- Stainless steel hob
- One touch ignition
- Metal clad knobs



## B G H . 0 5

### Standard Features

- 60 cm gas hob
- Surface design
- 4 gas burners
- Side knob control
- Enamel pan supports
- Enamel burner caps
- Flame safety device
- White enamel hob

### Optional Features

- One touch ignition



## B G H . 0 8

### Standard Features

- 60 cm gas hob
- White enamel hob
- 4 gas burners
- Side knob control
- Enamel pan supports
- Enamel burner caps
- Flame safety device

### Optional Features

- One touch ignition



## B G H . 0 2

### Standard Features

60 cm gas hob  
Surface design  
3 gas burners  
Ø 180mm hotplate  
Side knob control  
Flame safety device

### Optional Features

Stainless steel hob  
One touch ignition  
Cast iron pan supports  
Cast iron burner caps  
Metal clad knobs



## B G H . 0 7

### Standard Features

60 cm gas hob  
Surface design  
3 gas burners  
Ø 180mm hotplate  
Side knob control  
Enamel pan supports  
Enamel burner caps  
Flame safety device  
White enamel hob

### Optional Features

One touch ignition



## B G H . 0 3

### Standard Features

60 cm mixed hob  
3 gas burners  
180 mm hotplate  
Side knob control  
Enamel pan supports  
Enamel burner caps  
Flame safety device

### Optional Features

Stainless steel hob  
Electric hotplate  
One touch ignition  
Metal clad knobs



## B G H . 0 9

### Standard Features

60 cm gas hob  
 Surface design  
 4 gas burners  
 Side knob control  
 Flame safety device

### Optional Features

Stainless steel hob  
 One touch ignition  
 Wok burner  
 Cast iron pan supports  
 Cast iron burner caps



## B G H . 1 0

### Standard Features

60 cm gas hob  
 Surface design  
 3 gas burners  
 Ø 180mm hotplate  
 Side knob control  
 Flame safety device

### Optional Features

One touch ignition  
 Black enamel hob  
 Cast iron pan supports  
 Cast iron burner caps  
 Mat black knobs



## B G H . 0 1

### Standard Features

60 cm gas hob  
 Surface design  
 4 gas burners  
 Side knob control  
 Flame safety device

### Optional Features

Stainless steel hob  
 One touch ignition  
 Metal clad knobs  
 Cast iron pan supports  
 Cast iron burner caps



## B G H . 4 3

### Standard Features

60 cm gas hob  
 Extenda design  
 4 gas burners  
 Side knob control  
 Flame safety device

### Optional Features

Stainless steel  
 Cast iron burner caps  
 Cast iron pan supports  
 One touch ignition  
 Metal clad knobs



## B G H . 5 3

### Standard Features

60 cm mixed hob  
 Smootline design  
 3 gas burners  
 Ø 145 mm hotplate  
 Side knob control  
 Enamel pan supports  
 Enamel burner camps  
 Flame safety device

### Optional Features

One touch ignition



## B G H . 5 4

### Standard Features

60 cm gas hob  
 Smootline design  
 4 gas burners  
 Side knob control  
 Enamel pan supports  
 Enamel burner caps  
 Flame safety device

### Optional Features

Black enamelled hob  
 Button ignition





#### *Standard Features*

Smoothline design  
60 cm gas hob  
4 gas burners  
Side Knob control  
Enamel pan supports  
Enamel burner caps  
Flame safety device

#### *Optional Features*

Stainless steel hob  
Button ignition  
Metal clad knobs

### **B G H . 4 0**



#### *Standard Features*

Smoothline design  
60 cm gas hob  
4 gas burners  
Side Knob control  
Enamel pan supports  
Enamel burner caps  
White enamel hob

#### *Optional Features*

One touch ignition  
Flame safety device

### **B G H . 3 9**



#### *Standard Features*

Smoothline design  
60 cm gas hob  
4 gas burners  
Side Knob control  
Enamel pan supports  
Enamel burner caps  
Flame safety device

#### *Optional Features*

TDF enamel hob  
One touch ignition  
Black knobs

### **B G H . 4 1**



## B G H . 3 0 Rustic

### Standard Features

60 cm gas hob  
 Surface design  
 4 gas burners  
 Side knob control  
 Flame safety device  
 Enamel pan supports  
 Enamel burner caps

### Optional Features

Type-A Rustic design  
 Gold rustic knobs  
 One touch ignition  
 Black enamel hob



## B G H . 3 1 Rustic

### Standard Features

60 cm gas hob  
 Surface design  
 4 gas burners  
 Side knob control  
 Flame safety device  
 Enamel pan supports  
 Enamel burner caps  
 White enamel hob

### Optional Features

Antique gold rustic knob  
 Type-A rustic design  
 One touch ignition



## B G H . 2 8 Rustic

### Standard Features

60 cm gas hob  
 Surface design  
 4 gas burners  
 Side knob control  
 Flame safety device

### Optional Features

Type-B Rustic design  
 Chrome rustic knobs  
 One touch ignition  
 Black enamel hob  
 Cast iron pan supports  
 Cast iron burner caps



## **BEH.01**

### **Standard Features**

60 cm electric hob  
Surface design  
4 solid hotplates  
(2x145mm)+(2x180mm)  
Side knob control

### **Optional Features**

Stainless steel hob  
Black knobs



## **BEH.02**

### **Standard Features**

60 cm electric hob  
Surface design  
4 solid hotplates  
(2x145mm)+(2x180mm)  
Side knob control

### **Optional Features**

Black enamel hob  
Inox painted knobs



## **BEH.05**

### **Standard Features**

60cm electric hob  
Surface design  
4 solid hotplates  
(2x145mm)+(2x180mm)  
Side knob control

### **Optional Features**

Stainless steel hob



## **BCH.01**

### **Features**

60 cm electrical combi hob  
White enamel hob  
Combination with oven  
4 solid hotplates  
(2x145mm) + (2x180mm)



## **BCH.02**

### **Features**

60 cm electrical combi hob  
Black enamel hob  
Combination with oven  
4 solid hotplates  
(2x145mm) + (2x180mm)



## **BCH.03**

### **Standard Features**

60 cm electrical combi hob  
Combination with oven  
4 solid hotplates  
(2x145mm) + (2x180mm)

### **Optional Features**

1 Rapid hotplate  
Stainless steel hob



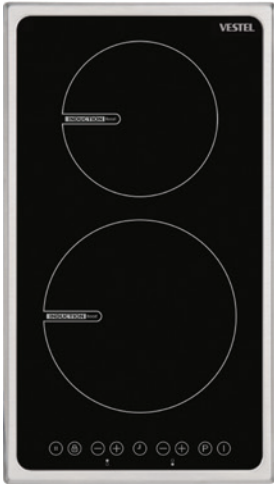

## DIHS 2.01 Domino Series 2

### Standard Features

30 cm ceramic hob  
 Domino series 2 design  
 Front touch control  
 Booster function  
 Ø 160 mm 1400 W / Boost  
 1800 W induction element  
 Ø 200 mm 2100 W / Boost  
 2500 W induction element  
 Child lock  
 Automatic heat up

Child lock  
 Hot surface indicator  
 Timer



## DVHS 2.02 Domino Series 2

### Standard Features

30 cm ceramic hob  
 Domino series 2 design  
 Front touch control  
 Ø 145 mm Highlight Element  
 1200W 700W/1700W  
 Hot surface indicator  
 Timer

### Optional Features

Ø 180 mm Dual Highlight  
 Element

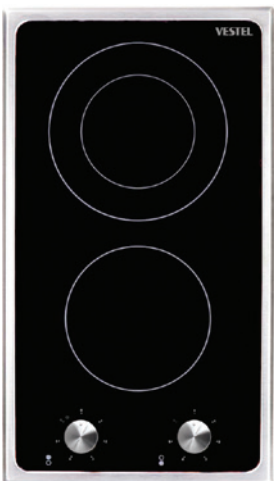

## DVHS 2.01 Domino Series 2

### Standard Features

30 cm ceramic hob  
 Domino series 2 design  
 Front knob control  
 Ø 145 mm Highlight Element  
 1200W 700W/1700W  
 Hot surface indicator light

### Optional Features

Ø 180 mm Dual Highlight  
 Element Metal cladded knobs



## DEHS 2.02 Domino Series 2

### Standard Features

30 cm electric hob  
Domino series 2 design  
Front knob control  
Ø 145 mm solid hotplate  
Ø 180 mm rapid hotplate

### Optional Features

Metal cladded knobs  
Mechanical timer  
1 rapid zone



## DEHS 2.01 Domino Series 2

### Standard Features

30 cm electric hob  
Domino series 2 design  
Front knob control  
Ø 145 mm solid hotplate  
Ø 180 mm rapid hotplate

### Optional Features

Metal cladded knobs  
1 rapid zone



## D G H S 2.05 Domino Series 2

### Standard Features

30 cm gas hob  
Domino series 2 design  
Stainless steel hob  
Wok burner  
Flame safety device  
Metal knob

### Optional Features

Mat enamel pan support  
Mat enamel burner pan  
One touch ignition

## D G H S 2 . 0 4 *Domino Series 2*



### **Standard Features**

30 cm gas hob  
Domino series 2 design  
Stainless steel hob  
2 gas burners  
Flame safety device

### **Optional Features**

Cast iron pan supports  
Cast iron burner caps  
One touch ignition  
Metal clad knobs

## D G H S 2 . 0 1 *Domino Series 2*



### **Standard Features**

30 cm gas on glass hob  
Domino series 2 design  
Black glass  
2 gas burners  
Flame safety device

### **Optional Features**

Cast iron pan supports  
Cast iron burner caps  
Inox burner pans  
One touch ignition  
Metal clad knobs

## D G H S 2 . 0 2 *Domino Series 2*



### **Standard Features**

30 cm gas on glass hob  
Domino series 2 design  
Black glass  
Wok burner  
Flame safety device

### **Optional Features**

Metal enamel burner pan  
Cast iron pan support  
Cast iron burner caps  
One touch ignition  
Metal clad knobs

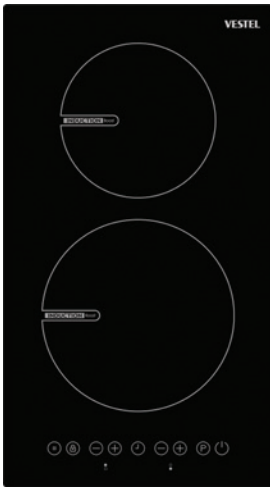

## DVHS 1.01 Domino Series 1

### Features

30 cm induction hob  
 Front touch control  
 Booster function  
 Ø 160 mm 1400 W / Boost  
 1800 W induction element  
 Ø 200 mm 2100 W / Boost  
 2500 W induction element  
 Pot detection  
 Automatic heat up

Child lock  
 Hot surface indicator  
 Timer

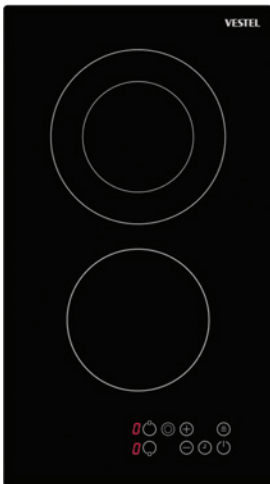

## DVHS 1.03 Domino Series 1

### Standard Features

30 cm ceramic hob  
 Front touch control  
 Ø 145 mm Highlight Element  
 1200W 700W/1700W  
 Child lock  
 Hot surface indicator  
 Key lock  
 Smart Pause  
 Timer

### Optional Features

Ø 180 mm Dual Highlight  
 Element

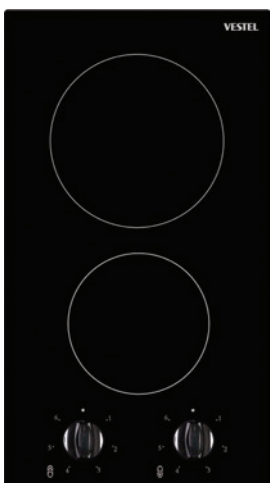

## DVHS 1.01 Domino Series 1

### Features

30 cm ceramic hob  
 Front knob control  
 Ø 145 mm Highlight Element  
 1200W  
 Ø 180 mm Highlight Element  
 1800W  
 Hot surface indicator light





## D G H S 1 . 0 3 *Domino Series 1*

### **Standard Features**

30 cm gas on glass hob  
 Domino series 1 design  
 Black glass  
 2 gas burners  
 Flame safety device

### **Optional Features**

Cast iron pan supports  
 Cast iron burner caps  
 Inox burner pans  
 One touch ignition



## D G H S 1 . 0 4 *Domino Series 1*

### **Standard Features**

30 cm gas on glass hob  
 Domino series 1 design  
 Black glass  
 Wok burner  
 Flame safety device

### **Optional Features**

Mat enamel pan support  
 Mat enamel burner pan  
 Inox burner pan  
 One touch ignition



## D G H S 1 . 0 1 *Domino Series 1*

### **Standard Features**

30 cm gas on glass hob  
 Domino series 1 design  
 Black glass  
 2 gas burners  
 Enamel pan supports  
 Enamel burner caps  
 Enamel burner pans  
 Flame safety device

### **Optional Features**

One touch ignition

## Built-In / Table-Top Hobs

### TT Gas/ Comnined/ Gas Securit Hobs

Flat / Surface  
Smoothline  
New Gen.  
PlusX

### TT Electric Hobs

Flat / Surface  
Smoothline  
New Gen.

## Hob Features

Hotplate Operation Indicator Light
Side Knob Control
Logo
Table Top Installation (not built-in)
Glass Lid
Burner Safety Valves
Button Ignition
One-touch-Ignition through knobs
Enamel Pan Supports
Cast Iron Pan Supports
Cast Iron Burner Caps
Coffee Adaptor
Wok Adaptor
Gas Conversion Kit
RoHS Compliance
CE Compliance
Carton Box Packaging

TABLE TOP HOB DESIGNS



New Generation Gas On Glass Design



New Generation Design



Standard Design

TABLE TOP AESTHETICS



New Generation Gas On Glass Table Top Hob Aesthetic



New Generation Table Top Hob Aesthetic



Standard Design "S-Type" Table Top Hob Aesthetic



Standard Design "Smootline" Table Top Hob Aesthetic



Standard Design "R-Type" Table Top Hob Aesthetic



Standard Design "Surface" Table Top Hob Aesthetic

TABLE TOP FRAME COLOR



White Painted



Black Painted



Inox Painted



Silver Painted



Stainless Steel

## TTGGH - S 2 . 0 1



### *Standard Features*

60cm gas on glass table top hob  
4 gas burners  
Front knob control  
Enamel burner pan  
Enamel burner caps and pan supports  
Flame Safety Device

### *Optional Features*

White optical glass cooktop  
White table top frame  
One touch ignition  
Inox cladded knobs

## TTGGH - S 2 . 0 2



### *Standard Features*

60cm gas on glass table top hob  
3 gas burners and 145mm hotplate  
Front knob control  
Black glass cooktop  
Enamel burner pan supports  
Flame Safety Device

### *Optional Features*

Cast Iron burner caps  
Cast Iron pan supports  
One touch ignition  
Stainless steel table top frame  
Inox cladded knobs  
Inox painted table top frame

## TTGGH - S 2 . 0 3



### *Standard Features*

60cm gas on glass table top hob  
4 gas burners  
Front knob control  
Black glass cooktop  
Enamel burner pan supports  
Flame Safety Device

### *Optional Features*

Wok Burner  
Cast Iron burner caps  
Cast Iron pan supports  
One touch ignition  
Inox cladded knobs  
Black table top frame



## TTGH - S 2.0 1



### Standard Features

- 60 cm table top gas hob
- New generation table top hob design
- 4 gas burners
- Side knob control
- Enamel cooktop
- Enamel burner pan supports
- Flame Safety Device

### Optional Features

- One touch ignition

## TTEH - S 2.0 1



### Standard Features

- 60 cm table top electric hob
- New generation table top hob design
- 4 solid hotplates (2x145mm)+(2x180mm)
- Side knob control
- Enamel cooktop

### Optional Features

- Rapid Hotplates (145mm and 180 mm)

## TTGH - S 2.0 2



### Standard Features

- 60 cm table top gas hob
- New generation table top hob design
- 4 gas burners
- Side knob control
- Flame Safety Device

### Optional Features

- Stainless steel cooktop
- Wok Burner
- One touch ignition
- Cast iron pan support
- Cast iron burner caps
- Glass cover lid
- Inox painted knobs

## TTGH - S1.01



### Standard Features

60 cm table top gas hob  
Standard type table top hob design  
Flat R-type cooktop aesthetics  
3 gas burners  
Ø180mm hotplate  
Side knob control  
Enamel pan supports and burner caps  
Flame Safety Device

### Optional Features

Stainless steel cooktop  
Inox painted table top frame  
One touch ignition  
Black Knobs

## TTEH - S1.02



### Standard Features

60 cm table top electrical hob  
Standard type table top hob design  
Flat S-type cooktop aesthetics  
4 solid hotplates  
(2x145mm)+(2x180mm)  
Side knob control

### Optional Features

Stainless steel cooktop  
Inox clad knobs  
Inox painted table top frame

## TTGH - S1.02



### Standard Features

60 cm table top gas hob  
Standard type table top hob design  
Smootline cooktop aesthetics  
3 gas burners  
Ø145mm hotplate  
Side knob control  
Enamel cooktop  
Enamel burner pan supports  
Flame Safety Device

### Optional Features

One touch ignition  
Inox painted knobs

## TTGH - S1.03



### Standard Features

- 60 cm table top gas hob
- Standard type table top hob design
- Smoothline cooktop aesthetics
- 4 gas burners
- Side knob control
- Enamel burner caps and pan supports
- Flame Safety Device

### Optional Features

- Stainless steel cooktop
- One touch ignition
- Inox painted knobs
- Inox painted table top frame

## TTGH - S1.04



### Standard Features

- 60 cm table top gas hob
- Standard type table top hob design
- Flat R-type cooktop aesthetics
- 4 gas burners
- Side knob control
- Enamel cooktop
- Enamel burner caps and pan supports
- Flame Safety Device

### Optional Features

- One touch ignition
- Glass lid

## TTGH - S1.05



### Standard Features

- 60 cm table top gas hob
- Standard type table top hob design
- Surface cooktop aesthetics
- 4 gas burners
- Side knob control
- Flame Safety Device

### Optional Features

- Stainless steel cooktop
- Wok Burner
- Cast Iron burner caps and pan supports
- One touch ignition
- Inox painted table top frame
- Glass lid
- Black knobs



## SPECIFICATIONS

*Dishwashers*





A1 SERIES 60cm Models BUILT-IN DISHWASHERS		A12	A1B	A13	A1C	A14	A1D	A15	A1E
<b>General Characteristics</b>									
<b>Number of place settings (PS)(1)</b>	12 PS (2 baskets)	Default	Default	Default	Default	Default	Default	Default	Default
	13 PS (2 baskets)	(o)	(o)	(o)	(o)	(o)	(o)	(o)	(o)
	13 PS (2 baskets + 3rd rack)	(o) with Aquazone	(o) with Aquazone	(o) with Aquazone	(o) with Aquazone	(o) with Aquazone	(o) with Aquazone	(o) with Aquazone	(o) with Aquazone
	14 PS (2 baskets + 3rd rack)	-	-	-	-	-	-	-	-
	15 PS (2 baskets + 3rd rack)	(o) with Aquazone and Turbo fan	(o) with Aquazone and Turbo fan	(o) with Aquazone and Turbo fan	(o) with Aquazone and Turbo fan	(o) with Aquazone and Turbo fan	(o) with Aquazone and Turbo fan	(o) with Aquazone and Turbo fan	(o) with Aquazone and Turbo fan
<b>Number of programmes</b>	3	3	4	4	5	5	6	6	
<b>Temperatures (°C)</b>	50-65	50-65	40-50-65	40-50-65	40-50-65-70	40-50-65-70	40-50-65-70	40-50-65-70	
<b>Control type</b>	Default	Button Control	Button Control	Button Control	Button Control	Button Control	Button Control	Button Control	Button Control
	Option	-	-	-	-	-	-	-	-
<b>Hidden heating element</b>	Yes	Yes	Yes	Yes	Yes	Yes	Yes	Yes	
<b>Filter type</b>	Metal	Default	Default	Default	Default	Default	Default	Default	Default
	Plastic	(o)	(o)	(o)	(o)	(o)	(o)	(o)	(o)
<b>Tub material</b>	Stainless Steel	Stainless Steel	Stainless Steel	Stainless Steel	Stainless Steel	Stainless Steel	Stainless Steel	Stainless Steel	
<b>Turbidity sensor (Smart Wash)</b>	(o) for 15 PS	(o) for 15 PS	(o) for 15 PS	(o) for 15 PS	(o) for 15 PS	(o) for 15 PS	(o) for 15 PS	(o) for 15 PS	
<b>Drying system</b>	Mini Active	Default	Default	Default	Default	Default	Default	Default	
	Super Active	(o)	(o)	(o)	(o)	(o)	(o)	(o)	
	Turbo	Default for 15 Ps	Default for 15 Ps	Default for 15 Ps	Default for 15 Ps	Default for 15 Ps	Default for 15 Ps	Default for 15 Ps	
<b>Electrical Diverter system</b>	-	-	-	-	-	-	-	-	
<b>Overflow &amp; leakage protection</b>	Yes	Yes	Yes	Yes	Yes	Yes	Yes	Yes	
<b>Heater protection</b>	Yes	Yes	Yes	Yes	Yes	Yes	Yes	Yes	
<b>Circulation pump</b>	Asynchronous	Yes	Yes	Yes	Yes	Yes	Yes	Yes	
	BLDC	-	-	-	-	-	-	-	
<b>Aquazone</b>	(o)	(o)	(o)	(o)	(o)	(o)	(o)	(o)	
<b>New Indoor Design</b>	(o)	(o)	(o)	(o)	(o)	(o)	(o)	(o)	
<b>Interior light</b>	one spot	(o)	(o)	(o)	(o)	(o)	(o)	(o)	
	four spot	(o)	(o)	(o)	(o)	(o)	(o)	(o)	
<b>Available Aesthetics*</b>	Freestanding	Angel, Carya, Daisy, Erica	Angel, Carya, Daisy, Erica	Angel, Carya, Daisy, Erica	Angel, Carya, Daisy, Erica	Angel, Carya, Daisy, Erica	Angel, Carya, Daisy, Erica	Angel, Carya, Daisy, Erica	
	Semi-Integrated	Daisy, Gardenya, Gardenya (Inox add-on)	Daisy, Gardenya, Gardenya (Inox add-on)	Daisy, Gardenya, Gardenya (Inox add-on)	Daisy, Gardenya, Gardenya (Inox add-on)	Daisy, Gardenya, Gardenya (Inox add-on)	Daisy, Gardenya, Gardenya (Inox add-on)	Daisy, Gardenya, Gardenya (Inox add-on)	
	Fully Integrated	-	-	-	-	-	-	-	
<b>Appliance Color Options</b>	Black, Dark Gray, Dark Inox, Dark Silver, Inox, White	Black, Dark Gray, Dark Inox, Dark Silver, Inox, White	Black, Dark Gray, Dark Inox, Dark Silver, Inox, White	Black, Dark Gray, Dark Inox, Dark Silver, Inox, White	Black, Dark Gray, Dark Inox, Dark Silver, Inox, White	Black, Dark Gray, Dark Inox, Dark Silver, Inox, White	Black, Dark Gray, Dark Inox, Dark Silver, Inox, White	Black, Dark Gray, Dark Inox, Dark Silver, Inox, White	
<b>Programmes</b>									
<b>Prewash</b>	-	-	-	-	-	-	Yes	Yes	
<b>Mini 14' (Jet Wash)</b>	-	-	-	-	-	-	-	-	
<b>Quick 30' 40°C</b>	-	-	Yes	Yes	Yes	Yes	Yes	Yes	
<b>Eco (Standard Programme)</b>	Yes	Yes	Yes	Yes	Yes	Yes	Yes	Yes	
<b>Super 50' 65°C (Quick Clean)</b>	Yes	Yes	Yes	Yes	Yes	Yes	Yes	Yes	
<b>Hygiene 70°C</b>	-	-	-	-	Yes	Yes	Yes	Yes	
<b>Intensive 65°C</b>	Yes	Yes	Yes	Yes	Yes	Yes	Yes	Yes	
<b>Auto**</b>	(o) for 15 PS	(o) for 15 PS	(o) for 15 PS	(o) for 15 PS	(o) for 15 PS	(o) for 15 PS	(o) for 15 PS	(o) for 15 PS	
<b>User Interface</b>									
<b>Start/Pause button</b>	Yes	Yes	Yes	Yes	Yes	Yes	Yes	Yes	
<b>DISPLAY TYPE [Mini / Large] (delay start, remaining time)</b>	-	Mini: LED	-	Mini: LED	-	Mini: LED	-	Mini: LED	
<b>Display Color</b>	Default	-	Red	-	Red	-	Red	-	
	Option	-	White	-	White	-	White	-	
<b>Prewash button</b>	-	-	-	-	-	-	-	-	
<b>Programme selection button</b>	Yes	Yes	Yes	Yes	Yes	Yes	Yes	Yes	
<b>Delay timer option</b>	3hr,6hr,9hr	Yes	-	Yes	-	Yes	-	Yes	
	1-2-3...-19hr	-	-	-	-	-	-	-	
	1-2-3...-24hr	-	Yes	-	Yes	-	Yes	-	
<b>Eco Wash - Half load option</b>	1 mode	Yes	Yes	Yes	Yes	Yes	Yes	Yes	
	3 modes	-	-	-	-	-	-	-	
<b>Tablet option</b>	Yes	Yes	Yes	Yes	Yes	Yes	Yes	Yes	
<b>Rinse-aid indicator</b>	Yes	Yes	Yes	Yes	Yes	Yes	Yes	Yes	
<b>Salt indicator</b>	Yes	Yes	Yes	Yes	Yes	Yes	Yes	Yes	
<b>Washing cycle indicators</b>	Yes	Yes	Yes	Yes	Yes	Yes	Yes	Yes	
<b>End of cycle indicator</b>	Yes	Yes	Yes	Yes	Yes	Yes	Yes	Yes	
<b>Child Lock</b>	Yes	Yes	Yes	Yes	Yes	Yes	Yes	Yes	
<b>Buzzer</b>	(o)	(o)	(o)	(o)	(o)	(o)	(o)	(o)	

A1 SERIES 60cm Models BUILT-IN DISHWASHERS		A12	A1B	A13	A1C	A14	A1D	A15	A1E
<b>Baskets &amp; Accessories</b>									
<b>3rd basket</b> [EasyTray, EcoTray or Comfort Tray]	12 PS	-	-	-	-	-	-	-	-
	13 PS	(o)	(o)	(o)	(o)	(o)	(o)	(o)	(o)
	14 PS	-	-	-	-	-	-	-	-
	15 PS	Yes	Yes	Yes	Yes	Yes	Yes	Yes	Yes
<b>Upper basket type [mesh type / peg type]</b>		(o)	(o)	(o)	(o)	(o)	(o)	(o)	(o)
<b>Adjustable upper basket</b> [empty/ loaded 2 level / loaded 3 level*]		(o)	(o)	(o)	(o)	(o)	(o)	(o)	(o)
<b>Number of mug shelves</b>		2 (std) / 4 (o)	2 (std) / 4 (o)	2 (std) / 4 (o)	2 (std) / 4 (o)	2 (std) / 4 (o)	2 (std) / 4 (o)	2 (std) / 4 (o)	2 (std) / 4 (o)
<b>Adjustable mug shelves</b>		Yes (peg type) / (o) (mesh type)	Yes (peg type) / (o) (mesh type)	Yes (peg type) / (o) (mesh type)	Yes (peg type) / (o) (mesh type)	Yes (peg type) / (o) (mesh type)	Yes (peg type) / (o) (mesh type)	Yes (peg type) / (o) (mesh type)	Yes (peg type) / (o) (mesh type)
<b>Mug shelves with soft touch rubber</b> (only with peg type basket)		(o)	(o)	(o)	(o)	(o)	(o)	(o)	(o)
<b>Foldable racks on upper basket</b> (only with peg type basket)		fixed (std) / 2 or 4 or 6 (o)	fixed (std) / 2 or 4 or 6 (o)	fixed (std) / 2 or 4 or 6 (o)	fixed (std) / 2 or 4 or 6 (o)	fixed (std) / 2 or 4 or 6 (o)	fixed (std) / 2 or 4 or 6 (o)	fixed (std) / 2 or 4 or 6 (o)	fixed (std) / 2 or 4 or 6 (o)
<b>Foldable racks on lower basket</b>		(o)	(o)	(o)	(o)	(o)	(o)	(o)	(o)
<b>Upper basket handle type [No / Wire / Plastic / Metal]</b>		(o)	(o)	(o)	(o)	(o)	(o)	(o)	(o)
<b>Lower basket handle type [No / Wire / Plastic / Metal]</b>		(o)	(o)	(o)	(o)	(o)	(o)	(o)	(o)
<b>Removable cutlery basket (Single piece)</b>		(o)(12/13ps) / No(15ps)	(o)(12/13ps) / No(15ps)	(o)(12/13ps) / No(15ps)	(o)(12/13ps) / No(15ps)	(o)(12/13ps) / No(15ps)	(o)(12/13ps) / No(15ps)	(o)(12/13ps) / No(15ps)	(o)(12/13ps) / No(15ps)
<b>Removable cutlery basket (Universal)</b>		No(12/13ps) / (o)(15ps)	No(12/13ps) / (o)(15ps)	No(12/13ps) / (o)(15ps)	No(12/13ps) / (o)(15ps)	No(12/13ps) / (o)(15ps)	No(12/13ps) / (o)(15ps)	No(12/13ps) / (o)(15ps)	No(12/13ps) / (o)(15ps)
<b>Removable cutlery basket (Modular) (2)</b>		(o)	(o)	(o)	(o)	(o)	(o)	(o)	(o)
<b>Removable cutlery basket (Sliding) (3)</b>		(o)(12/13ps) / No(15ps)	(o)(12/13ps) / No(15ps)	(o)(12/13ps) / No(15ps)	(o)(12/13ps) / No(15ps)	(o)(12/13ps) / No(15ps)	(o)(12/13ps) / No(15ps)	(o)(12/13ps) / No(15ps)	(o)(12/13ps) / No(15ps)
<b>Multi functional kit</b> (Extra mug shelves + higher rear part on lower basket)		(o)	(o)	(o)	(o)	(o)	(o)	(o)	(o)
<b>Bottle holder on lower basket</b>		(o)	(o)	(o)	(o)	(o)	(o)	(o)	(o)
<b>Wine stem support &amp; Spoon rack on upper basket (2)</b>		(o)	(o)	(o)	(o)	(o)	(o)	(o)	(o)
<b>Wine glass holder on lower basket</b>		(o) with 4 foldable racks	(o) with 4 foldable racks	(o) with 4 foldable racks	(o) with 4 foldable racks	(o) with 4 foldable racks	(o) with 4 foldable racks	(o) with 4 foldable racks	(o) with 4 foldable racks
<b>Top nozzle</b>	fixed type with 2 baskets	(o) with Aquazone	(o) with Aquazone	(o) with Aquazone	(o) with Aquazone	(o) with Aquazone	(o) with Aquazone	(o) with Aquazone	(o) with Aquazone
	rotating type	Default with 3rd basket	Default with 3rd basket	Default with 3rd basket	Default with 3rd basket	Default with 3rd basket	Default with 3rd basket	Default with 3rd basket	Default with 3rd basket
<b>Aquastop external hose</b>		(o)	(o)	(o)	(o)	(o)	(o)	(o)	(o)
<b>Antibacterial filter</b>		(o)	(o)	(o)	(o)	(o)	(o)	(o)	(o)
<b>Anti-siphon system</b>		(o)	(o)	(o)	(o)	(o)	(o)	(o)	(o)
<b>Technical Data (4)</b>									
<b>Sound level (dB(A) re 1 pW)</b>	12 PS	57 / 54 / 52 / 49 / 47 / 45	57 / 54 / 52 / 49 / 47 / 45	57 / 54 / 52 / 49 / 47 / 45	57 / 54 / 52 / 49 / 47 / 45	57 / 54 / 52 / 49 / 47 / 45	57 / 54 / 52 / 49 / 47 / 45	57 / 54 / 52 / 49 / 47 / 45	57 / 54 / 52 / 49 / 47 / 45
	13 PS	57 / 54 / 52 / 49 / 47 / 45	57 / 54 / 52 / 49 / 47 / 45	57 / 54 / 52 / 49 / 47 / 45	57 / 54 / 52 / 49 / 47 / 45	57 / 54 / 52 / 49 / 47 / 45	57 / 54 / 52 / 49 / 47 / 45	57 / 54 / 52 / 49 / 47 / 45	57 / 54 / 52 / 49 / 47 / 45
	14 PS	-	-	-	-	-	-	-	-
	15 PS	49 / 47 / 45	49 / 47 / 45	49 / 47 / 45	49 / 47 / 45	49 / 47 / 45	49 / 47 / 45	49 / 47 / 45	49 / 47 / 45
<b>Energy efficiency class</b>		A++	A++	A++	A++	A++	A++	A++	A++
<b>Energy efficiency index</b>	12 PS	55,8	55,8	55,8	55,8	55,8	55,8	55,8	55,8
	13 PS	55,6	55,6	55,6	55,6	55,6	55,6	55,6	55,6
	14 PS	-	-	-	-	-	-	-	-
	15 PS	55,8	55,8	55,8	55,8	55,8	55,8	55,8	55,8
<b>Cleaning efficiency class</b>		A	A	A	A	A	A	A	A
<b>Cleaning efficiency index</b>		1,13	1,13	1,13	1,13	1,13	1,13	1,13	1,13
<b>Drying efficiency class</b>		A	A	A	A	A	A	A	A
<b>Technical Data (4)</b>									
<b>Drying efficiency index</b>		1,09	1,09	1,09	1,09	1,09	1,09	1,09	1,09
<b>Standard programme water consumption (lt / cycle)</b>	Default	12,0	12,0	12,0	12,0	12,0	12,0	12,0	12,0
	with Aquazone	9,0	9,0	9,0	9,0	9,0	9,0	9,0	9,0
<b>Annual water consumption (lt / year)</b>	Default	3360	3360	3360	3360	3360	3360	3360	3360
	with Aquazone	2520	2520	2520	2520	2520	2520	2520	2520
<b>Duration of the standard programme (min)</b>	Default	205	205	205	205	205	205	205	205
	with Aquazone	221	221	221	221	221	221	221	221
<b>Standard programme energy consumption (kWh / cycle)</b>	12 PS	0,907	0,907	0,907	0,907	0,907	0,907	0,907	0,907
	13 PS	0,917	0,917	0,917	0,917	0,917	0,917	0,917	0,917
	14 PS	-	-	-	-	-	-	-	-
	15 PS	0,949	0,949	0,949	0,949	0,949	0,949	0,949	0,949
<b>Annual energy consumption (kWh / year)</b>	12 PS	258	258	258	258	258	258	258	258
	13 PS	261	261	261	261	261	261	261	261
	14 PS	-	-	-	-	-	-	-	-
	15 PS	270	270	270	270	270	270	270	270
<b>Off mode power consumption (W)</b>		0,50	0,50	0,50	0,50	0,50	0,50	0,50	0,50

A1 SERIES 60cm Models BUILT-IN DISHWASHERS		A12	A1B	A13	A1C	A14	A1D	A15	A1E
<b>Technical Data (4)</b>									
<b>Left-on mode power consumption (W)</b>		1,00	1,00	1,00	1,00	1,00	1,00	1,00	1,00
<b>Network standby mode power consumption (W)</b>		N/A	N/A	N/A	N/A	N/A	N/A	N/A	N/A
<b>Duration of left-on mode (min)</b>		15	15	15	15	15	15	15	15
<b>Power rating (W) / Heating element (W)</b>		1900 / 1800	1900 / 1800	1900 / 1800	1900 / 1800	1900 / 1800	1900 / 1800	1900 / 1800	1900 / 1800
<b>Plug Type</b>		EU / UK / Swiss / Italy / Israel / AU/NZ / China / Argentina / S.África	EU / UK / Swiss / Italy / Israel / AU/NZ / China / Argentina / S.África	EU / UK / Swiss / Italy / Israel / AU/NZ / China / Argentina / S.África	EU / UK / Swiss / Italy / Israel / AU/NZ / China / Argentina / S.África	EU / UK / Swiss / Italy / Israel / AU/NZ / China / Argentina / S.África	EU / UK / Swiss / Italy / Israel / AU/NZ / China / Argentina / S.África	EU / UK / Swiss / Italy / Israel / AU/NZ / China / Argentina / S.África	EU / UK / Swiss / Italy / Israel / AU/NZ / China / Argentina / S.África
<b>Power cord length (cm)</b>		165	165	165	165	165	165	165	165
<b>Water inlet hose length (cm)</b>	Default	147	147	147	147	147	147	147	147
	with Aquastop ext. hose	170	170	170	170	170	170	170	170
<b>Water outlet hose length (cm)</b>		200	200	200	200	200	200	200	200
<b>Voltage (V) / Frequency (Hz) / Fuse Rating (A)</b>		220-240 / 50 / 10	220-240 / 50 / 10	220-240 / 50 / 10	220-240 / 50 / 10	220-240 / 50 / 10	220-240 / 50 / 10	220-240 / 50 / 10	220-240 / 50 / 10
<b>Water pressure range (bar)</b>		0,3 - 10	0,3 - 10	0,3 - 10	0,3 - 10	0,3 - 10	0,3 - 10	0,3 - 10	0,3 - 10
<b>Dimensions</b>									
<b>Height (cm)</b>	Freestanding	85,0	85,0	85,0	85,0	85,0	85,0	85,0	85,0
	Semi-Integrated	82,0	82,0	82,0	82,0	82,0	82,0	82,0	82,0
	Fully Integrated	-	-	-	-	-	-	-	-
<b>Width (cm)</b>		59,8	59,8	59,8	59,8	59,8	59,8	59,8	59,8
<b>Depth (cm)</b>	Freestanding	59,8	59,8	59,8	59,8	59,8	59,8	59,8	59,8
	Semi-Integrated	57,0	57,0	57,0	57,0	57,0	57,0	57,0	57,0
	Fully Integrated	-	-	-	-	-	-	-	-
<b>Height adjustment (+cm)</b>	Freestanding	2	2	2	2	2	2	2	2
	Semi-Integrated	5	5	5	5	5	5	5	5
	Fully Integrated	-	-	-	-	-	-	-	-
<b>Adjustable Plinth for undertable usage (mm) Undertable</b>		(o) (80 or/ and 130)	(o) (80 or/ and 130)	(o) (80 or/ and 130)	(o) (80 or/ and 130)	(o) (80 or/ and 130)	(o) (80 or/ and 130)	(o) (80 or/ and 130)	(o) (80 or/ and 130)
<b>Possible adjustment of the plinth Undertable (horizontal / vertical) (mm / mm)</b>		0-100 / 0-50	0-100 / 0-50	0-100 / 0-50	0-100 / 0-50	0-100 / 0-50	0-100 / 0-50	0-100 / 0-50	0-100 / 0-50
<b>Height without worktop (cm) Undertable</b>		82,0	82,0	82,0	82,0	82,0	82,0	82,0	82,0
<b>Decorative panel height (max) (cm) Semi-Integrated</b>		59,7	59,7	59,7	59,7	59,7	59,7	59,7	59,7
<b>Plinth height (min) (cm) Semi-Integrated</b>		8	8	8	8	8	8	8	8
<b>Plinth depth (cm) Semi-Integrated</b>		3 - 8	3 - 8	3 - 8	3 - 8	3 - 8	3 - 8	3 - 8	3 - 8
<b>Packed dimensions (Width x Depth x Height) (cm)</b>	Freestanding	64.4 x 66.1 x 88.1	64.4 x 66.1 x 88.1	64.4 x 66.1 x 88.1	64.4 x 66.1 x 88.1	64.4 x 66.1 x 88.1	64.4 x 66.1 x 88.1	64.4 x 66.1 x 88.1	64.4 x 66.1 x 88.1
	Semi-Integrated	64.4 x 66.1 x 85.1	64.4 x 66.1 x 85.1	64.4 x 66.1 x 85.1	64.4 x 66.1 x 85.1	64.4 x 66.1 x 85.1	64.4 x 66.1 x 85.1	64.4 x 66.1 x 85.1	64.4 x 66.1 x 85.1
	Fully Integrated	-	-	-	-	-	-	-	-
<b>Stacking quantity (pcs)</b>	Freestanding	6 (2 baskets) / 4 (3rd basket)	6 (2 baskets) / 4 (3rd basket)	6 (2 baskets) / 4 (3rd basket)	6 (2 baskets) / 4 (3rd basket)	6 (2 baskets) / 4 (3rd basket)	6 (2 baskets) / 4 (3rd basket)	6 (2 baskets) / 4 (3rd basket)	6 (2 baskets) / 4 (3rd basket)
	Semi-Integrated	6	6	6	6	6	6	6	6
	Fully Integrated	-	-	-	-	-	-	-	-
<b>Gross/Net weight (kg)(5)</b>	Freestanding	49 /46 - 56 /53	49 /46 - 56 /53	49 /46 - 56 /53	49 /46 - 56 /53	49 /46 - 56 /53	49 /46 - 56 /53	49 /46 - 56 /53	49 /46 - 56 /53
	Semi-Integrated	43 /41	43 /41	43 /41	43 /41	43 /41	43 /41	43 /41	43 /41
	Fully Integrated	-	-	-	-	-	-	-	-
<b>Container loading (40"HC/ 40" / 20")</b>		162 /108 /54	162 /108 /54	162 /108 /54	162 /108 /54	162 /108 /54	162 /108 /54	162 /108 /54	162 /108 /54

Notes

(o) : Optional

(\*) : See roadmap for availability

(\*\*) : Auto programme can be chosen instead of Intensive programme (with turbidity sensor).

(1) : Turbo Fan feature & 3rd basket (& Aquazone for w/o diverter models) are default for 15 PS models.

For w/o diverter models; 3rd basket can be selected only with Aquazone"

(2) : Modular cutlery basket for 12/13 PS must be selected with wine stem support & spoon rack. Also wine stem support & spoon rack can be selected only for mesh type upper basket option.

(3) : Can be selected for lower basket with fixed type or with 4 foldable wire.

(4) : Based on the tests performed with Eco programme in accordance with European Household Dishwasher Performance Standards

(5) : Gross/Net Weights are shown as reference in the table. It should be calculated based on the final product features created from this general spec table.

A2 SERIES 60cm Models BUILT-IN DISHWASHERS		A21	A22	A23	A24	A25	A26
<b>General Characteristics</b>							
<b>Number of place settings (PS)(1)</b>	12 PS (2 baskets)	Default	Default	Default	Default	-	Default
	13 PS (2 baskets)	(o)	(o)	(o)	(o)	-	(o)
	13 PS (2 baskets + 3rd rack)	(o)	(o)	(o)	(o)	-	(o)
	14 PS (2 baskets + 3rd rack)	-	-	-	-	Default	-
	15 PS (2 baskets + 3rd rack)	(o) with Turbo fan	(o) with Turbo fan	(o) with Turbo fan	(o)	-	(o)
<b>Number of programmes</b>	6	7	8+	8+	8+	8+	
<b>Temperatures (°C)</b>	40-50-65	40-50-60-65	Auto-30-40-50-60-65-70	Auto-30-40-50-60-65-70	Auto-30-40-50-60-65-70	Auto-30-40-50-60-65-70	
<b>Control type</b>	Default	Button Control	Button Control	Button Control	Button Control	Button Control	Button Control
	Option	-	-	-	-	-	-
<b>Hidden heating element</b>	Yes	Yes	Yes	Yes	Yes	Yes	
<b>Filter type</b>	Metal	Default	Default	Default	Default	Default	Default
	Plastic	(o)	(o)	(o)	-	-	-
<b>Tub material</b>	Stainless Steel	Stainless Steel	Stainless Steel	Stainless Steel	Stainless Steel	Stainless Steel	
<b>Turbidity sensor (Smart Wash)</b>	(o)	(o)	Yes	Yes	Yes	Yes	
<b>Drying system</b>	Mini Active	Default	Default	Default	-	-	-
	Super Active	(o)	(o)	(o)	-	-	-
	Turbo	(o)	(o)	(o)	Default	Default	Default
<b>Electrical Diverter system</b>	Yes	Yes	Yes	Yes	Yes	Yes	
<b>Overflow &amp; leakage protection</b>	Yes	Yes	Yes	Yes	Yes	Yes	
<b>Heater protection</b>	Yes	Yes	Yes	Yes	Yes	Yes	
<b>Circulation pump</b>	Asynchronous	Yes	Yes	Yes	-	-	-
	BLDC	-	-	-	Yes	Yes	Yes
<b>Auto Door</b>	-	-	-	Yes	Yes	-	
<b>Water Box</b>	-	-	-	-	Yes	-	
<b>Triple &amp; Direct Wash*</b>	-	-	-	(o)	(o)	(o)	
<b>Aquazone</b>	-	-	-	-	-	-	
<b>Wi-fi*</b>	(o)	(o)	(o)	(o)	(o)	(o)	
<b>New Indoor Design</b>	(o)	(o)	(o)	(o)	(o)	(o)	
<b>Sliding Door</b>	-	-	-	-	-	-	
<b>Ion Tech</b>	(o)	(o)	(o)	(o)	(o)	(o)	
<b>Uvon Tech*</b>	-	-	-	(o)	(o)	(o)	
<b>InfoLED</b>	1,0	-	-	-	-	-	
	2,0 (Floor Indicator)	-	-	-	-	-	
<b>Interior light</b>	one spot	(o)	(o)	(o)	(o)	(o)	
	four spot	(o)	(o)	(o)	(o)	(o)	
<b>Available Aesthetics*</b>	Freestanding	Angel, Carya, Daisy, Erica	Angel, Carya, Daisy, Erica	Angel, Carya, Daisy, Erica	Angel, Carya, Daisy, Erica	Angel, Carya, Daisy, Erica	
	Semi-Integrated	Daisy, Gardenya, Gardenya (Inox add-on)	Daisy, Gardenya, Gardenya (Inox add-on)	Daisy, Gardenya, Gardenya (Inox add-on)	Daisy, Gardenya, Gardenya (Inox add-on)	Daisy, Gardenya, Gardenya (Inox add-on)	
	Fully Integrated	-	-	-	-	-	
<b>Appliance Color Options</b>	Black, Dark Gray, Dark Inox, Dark Silver, Inox, White	Black, Dark Gray, Dark Inox, Dark Silver, Inox, White	Black, Dark Gray, Dark Inox, Dark Silver, Inox, White	Black, Dark Gray, Dark Inox, Dark Silver, Inox, White	Black, Dark Gray, Dark Inox, Dark Silver, Inox, White	Black, Dark Gray, Dark Inox, Dark Silver, Inox, White	
<b>Programmes</b>							
<b>Prewash</b>	Yes	Yes	Yes	-	-	-	
<b>Mini 14' (Jet Wash)</b>	-	-	-	Yes	Yes	Yes	
<b>Quick 30' 40°C</b>	Yes	Yes	Yes	Yes	Yes	Yes	
<b>Eco (Standard Programme)</b>	Yes	Yes	Yes	Yes	Yes	Yes	
<b>Super 50' 65°C (Quick Clean)</b>	Yes	Yes	Yes	Yes	Yes	Yes	
<b>Delicate 40°C</b>	Yes	Yes	-	-	-	-	
<b>Daily 60°C / Hybrid Wash 60°C</b>	-	Yes	Yes	-	-	-	
<b>Dual Pro Wash 60°C</b>	-	-	-	Yes	Yes	Yes	
<b>Intensive 65°C</b>	Yes	Yes	-	-	-	-	
<b>Auto**</b>	(o)	(o)	-	-	-	-	
<b>Auto Delicate 30°C - 50°C</b>	-	-	Yes	Yes	Yes	Yes	
<b>Auto Normal 50°C - 60°C / Auto Flex 50°C - 60°C</b>	-	-	Yes	Yes	-	Yes	
<b>Auto Intensive 60°C - 70°C</b>	-	-	Yes	Yes	Yes (50°C-70°C)	Yes	
<b>Eco 5.4 lt / Save+ 5.4 lt</b>	-	-	-	-	Yes	-	
<b>User Interface</b>							
<b>Start/Pause button</b>	Yes	Yes	Yes	Yes	Yes	Yes	
<b>DISPLAY TYPE [Mini / Large] (delay start, remaining time)</b>	Mini or Large: LED	Mini or Large: LED	Mini or Large: LED	Mini or Large: LED	Mini or Large: LED	Mini or Large: LED	
<b>Display Color</b>	Default	Red	Red	Red	Red	Red	
	Option	White	White	White	White	White	
<b>Prewash button</b>	-	-	-	-	-	-	
<b>Programme selection button</b>	Yes	Yes	Yes	Yes	Yes	Yes	



A2 SERIES 60cm Models BUILT-IN DISHWASHERS		A21	A22	A23	A24	A25	A26
<b>User Interface</b>							
<b>Delay timer option</b>	3hr,6hr,9hr	-	-	-	-	-	-
	1-2-3-...-19hr	-	-	-	-	-	-
	1-2-3-...-24hr	Yes	Yes	Yes	Yes	Yes	Yes
<b>Eco Wash - Half load option</b>	1 mode	-	-	-	-	-	-
	3 modes	Yes	Yes	Yes	Yes	Yes	Yes
<b>Tablet option</b>		Yes	Yes	Yes	Yes	Yes	Yes
<b>Extra Hygiene option</b>		Yes	Yes	Yes	Yes	Yes	Yes
<b>Extra Rinse option</b>		Yes	Yes	Yes	-	-	-
<b>Extra Drying option</b>		Yes	Yes	Yes	-	-	Yes
<b>Extra Silent option (Silent Wash)</b>		-	-	-	Yes	Yes	Yes
<b>Extra Fast option</b>		-	-	-	Yes	Yes	Yes
<b>Energy Save option</b>		-	-	-	Yes	Yes	-
<b>Rinse-aid indicator</b>		Yes	Yes	Yes	Yes	Yes	Yes
<b>Salt indicator</b>		Yes	Yes	Yes	Yes	Yes	Yes
<b>Washing cycle indicators</b>		Yes	Yes	Yes	Yes	Yes	Yes
<b>End of cycle indicator</b>		Yes	Yes	Yes	Yes	Yes	Yes
<b>Child Lock</b>		Yes	Yes	Yes	Yes	Yes	Yes
<b>Buzzer</b>		(o)	(o)	(o)	Yes	Yes	(o)
<b>Baskets &amp; Accessories</b>							
<b>3rd basket [EasyTray, EcoTray or Comfort Tray]</b>	12 PS	-	-	-	-	-	-
	13 PS	(o)	(o)	(o)	(o)	-	(o)
	14 PS	-	-	-	-	Yes	-
	15 PS	Yes	Yes	Yes	Yes	-	Yes
<b>Upper basket type [mesh type / peg type]</b>		(o)	(o)	(o)	(o)	Peg	(o)
<b>Adjustable upper basket [empty/ loaded 2 level / loaded 3 level*]</b>		(o)	(o)	(o)	(o)	(o)	(o)
<b>Number of mug shelves</b>		2 (std) / 4 (o)	2 (std) / 4 (o)	2 (std) / 4 (o)	2 (std) / 4 (o)	4	2 (std) / 4 (o)
<b>Adjustable mug shelves</b>		Yes (peg type) / (o) (mesh type)	Yes (peg type) / (o) (mesh type)	Yes (peg type) / (o) (mesh type)	Yes (peg type) / (o) (mesh type)	Yes	Yes (peg type) / (o) (mesh type)
<b>Mug shelves with soft touch rubber (only with peg type basket)</b>		(o)	(o)	(o)	(o)	(o)	(o)
<b>Foldable racks on upper basket (only with peg type basket)</b>		fixed (std) / 2 or 4 or 6 (o)	fixed (std) / 2 or 4 or 6 (o)	fixed (std) / 2 or 4 or 6 (o)	fixed (std) / 2 or 4 or 6 (o)	4 or 6 (o)	fixed (std) / 2 or 4 or 6 (o)
<b>Foldable racks on lower basket</b>		(o)	(o)	(o)	(o)	Yes	(o)
<b>Upper basket handle type [No / Wire / Plastic / Metal]</b>		(o)	(o)	(o)	(o)	(o)	(o)
<b>Lower basket handle type [No / Wire / Plastic / Metal]</b>		(o)	(o)	(o)	(o)	(o)	(o)
<b>Removable cutlery basket (Single piece)</b>		(o)(12/13ps) / No(15ps)	(o)(12/13ps) / No(15ps)	(o)(12/13ps) / No(15ps)	(o)(12/13ps) / No(15ps)	-	(o)(12/13ps) / No(15ps)
<b>Removable cutlery basket (Universal)</b>		No(12/13ps) / (o)(15ps)	No(12/13ps) / (o)(15ps)	No(12/13ps) / (o)(15ps)	No(12/13ps) / (o)(15ps)	(o)	No(12/13ps) / (o)(15ps)
<b>Removable cutlery basket (Modular) (2)</b>		(o)	(o)	(o)	(o)	(o)	(o)
<b>Removable cutlery basket (Sliding) (3)</b>		(o)(12/13ps) / No(15ps)	(o)(12/13ps) / No(15ps)	(o)(12/13ps) / No(15ps)	(o)(12/13ps) / No(15ps)	-	(o)(12/13ps) / No(15ps)
<b>Multi functional kit (Extra mug shelves + higher rear part on lower basket)</b>		(o)	(o)	(o)	(o)	(o)	(o)
<b>Bottle holder on lower basket</b>		(o)	(o)	(o)	(o)	(o)	(o)
<b>Wine stem support &amp; Spoon rack on upper basket (2)</b>		(o)	(o)	(o)	(o)	-	(o)
<b>Wine glass holder on lower basket</b>		(o) with 4 foldable racks	(o) with 4 foldable racks	(o) with 4 foldable racks	(o) with 4 foldable racks	(o) with 4 foldable racks	(o) with 4 foldable racks
<b>Top nozzle</b>	fixed type with 2 baskets	(o)	(o)	(o)	(o)	-	(o)
	rotating type	Default with 3rd basket	Default with 3rd basket	Default with 3rd basket	Default with 3rd basket	Default	Default with 3rd basket
<b>Aquastop external hose</b>		(o)	(o)	(o)	(o)	(o)	(o)
<b>Antibacterial filter</b>		(o)	(o)	(o)	(o)	(o)	(o)
<b>Anti-siphon system</b>		(o)	(o)	(o)	(o)	(o)	(o)
<b>Technical Data (4)</b>							
<b>Sound level (dB(A) re 1 pW)</b>	12 PS	57 / 54 / 52 / 49 / 47 / 45	57 / 54 / 52 / 49 / 47 / 45	57 / 54 / 52 / 49 / 47 / 45	46 / 44	-	49 / 47 / 45 / 44 / 42 / 41
	13 PS	57 / 54 / 52 / 49 / 47 / 45	57 / 54 / 52 / 49 / 47 / 45	57 / 54 / 52 / 49 / 47 / 45	46 / 44	-	49 / 47 / 45 / 44 / 42 / 41
	14 PS	-	-	-	-	44	-
	15 PS	49 / 47 / 45	49 / 47 / 45	49 / 47 / 45	44 / 42	-	49 / 47 / 45 / 44 / 42 / 41 / 39
<b>Energy efficiency class</b>		A++	A++	A++	A+++	A+++ -20%	A+++
<b>Energy efficiency index</b>	12 PS	55,8	55,8	55,8	49,7	-	49,7
	13 PS	55,6	55,6	55,6	49,8	-	49,8
	14 PS	-	-	-	-	39,6	-
	15 PS	55,8	55,8	55,8	49,8	-	49,8
<b>Cleaning efficiency class</b>		A	A	A	A	A	A
<b>Cleaning efficiency index</b>		1,13	1,13	1,13	1,13	1,13	1,13
<b>Drying efficiency class</b>		A	A	A	A	A	A
<b>Drying efficiency index</b>		1,09	1,09	1,09	1,09	1,09	1,09

A2 SERIES 60cm Models BUILT-IN DISHWASHERS		A21	A22	A23	A24	A25	A26
<b>Technical Data (4)</b>							
<b>Standard programme water consumption (lt / cycle)</b>	Default	9,0	9,0	9,0	9,0	9,0	9,0
	with Aquazone	-	-	-	-	-	-
<b>Annual water consumption (lt / year)</b>	Default	2520	2520	2520	2520	2520	2520
	with Aquazone	-	-	-	-	-	-
<b>Duration of the standard programme (min)</b>	Default	171	171	171	239	207	270
	with Aquazone	-	-	-	-	-	-
<b>Standard programme energy consumption (kWh / cycle)</b>	12 PS	0,907	0,907	0,907	0,807	-	0,807
	13 PS	0,917	0,917	0,917	0,821	-	0,821
	14 PS	-	-	-	-	0,660	-
	15 PS	0,949	0,949	0,949	0,846	-	0,846
<b>Annual energy consumption (kWh / year)</b>	12 PS	258	258	258	230	-	230
	13 PS	261	261	261	234	-	234
	14 PS	-	-	-	-	189	-
	15 PS	270	270	270	241	-	241
<b>Off mode power consumption (W)</b>		0,50	0,50	0,50	0,50	0,50	0,50
<b>Left-on mode power consumption (W)</b>		1,00	1,00	1,00	1,00	1,00	1,00
<b>Network standby mode power consumption (W)</b>		N/A	N/A	N/A	N/A	N/A	N/A
<b>Duration of left-on mode (min)</b>		15	15	15	15	15	15
<b>Power rating (W) / Heating element (W)</b>		1900 / 1800	1900 / 1800	1900 / 1800	1900 / 1800	1900 / 1800	1900 / 1800
<b>Plug Type</b>		EU / UK / Swiss / Italy / Israel / AU/NZ / China / Argentina / S.Africa	EU / UK / Swiss / Italy / Israel / AU/NZ / China / Argentina / S.Africa	EU / UK / Swiss / Italy / Israel / AU/NZ / China / Argentina / S.Africa	EU / UK / Swiss / Italy / Israel / AU/NZ / China / Argentina / S.Africa	EU / UK / Swiss / Italy / Israel / AU/NZ / China / Argentina / S.Africa	EU / UK / Swiss / Italy / Israel / AU/NZ / China / Argentina / S.Africa
<b>Power cord length (cm)</b>		165	165	165	165	165	165
<b>Water inlet hose length (cm)</b>	Default	147	147	147	147	147	147
	with Aquastop ext. hose	170	170	170	170	170	170
<b>Water outlet hose length (cm)</b>		200	200	200	200	200	200
<b>Voltage (V) / Frequency (Hz) / Fuse Rating (A)</b>		220-240 / 50 / 10	220-240 / 50 / 10	220-240 / 50 / 10	220-240 / 50 / 10	220-240 / 50 / 10	220-240 / 50 / 10
<b>Water pressure range (bar)</b>		0,3 - 10	0,3 - 10	0,3 - 10	0,3 - 10	0,3 - 10	0,3 - 10
<b>Dimensions</b>							
<b>Height (cm)</b>	Freestanding	85,0	85,0	85,0	85,0	85,0	85,0
	Semi-Integrated	82,0	82,0	82,0	82,0	82,0	82,0
	Fully Integrated	-	-	-	-	-	-
<b>Width (cm)</b>		59,8	59,8	59,8	59,8	59,8	59,8
<b>Depth (cm)</b>	Freestanding	59,8	59,8	59,8	59,8	59,8	59,8
	Semi-Integrated	57,0	57,0	57,0	57,0	57,0	57,0
	Fully Integrated	-	-	-	-	-	-
<b>Height adjustment (+cm)</b>	Freestanding	2	2	2	2	2	2
	Semi-Integrated	5	5	5	5	5	5
	Fully Integrated	-	-	-	-	-	-
<b>Adjustable Plinth for undertable usage (mm) Undertable</b>		(o) (80 or/and 130)	(o) (80 or/and 130)	(o) (80 or/and 130)	(o) (80 or/and 130)	(o) (80 or/and 130)	(o) (80 or/and 130)
<b>Possible adjustment of the plinth Undertable (horizontal / vertical) (mm / mm)</b>		0-100 / 0-50	0-100 / 0-50	0-100 / 0-50	0-100 / 0-50	0-100 / 0-50	0-100 / 0-50
<b>Height without worktop (cm) Undertable</b>		82,0	82,0	82,0	82,0	82,0	82,0
<b>Decorative panel height (max) (cm) Semi-Integrated</b>		59,7	59,7	59,7	59,7	59,7	59,7
<b>Plinth height (min) (cm) Semi-Integrated</b>		8	8	8	8	8	8
<b>Plinth depth (cm) Semi-Integrated</b>		3 - 8	3 - 8	3 - 8	3 - 8	3 - 8	3 - 8
<b>Packed dimensions (Width x Depth x Height) (cm)</b>	Freestanding	64.4 x 66.1 x 88.1	64.4 x 66.1 x 88.1	64.4 x 66.1 x 88.1	64.4 x 66.1 x 88.1	64.4 x 66.1 x 88.1	64.4 x 66.1 x 88.1
	Semi-Integrated	64.4 x 66.1 x 85.1	64.4 x 66.1 x 85.1	64.4 x 66.1 x 85.1	64.4 x 66.1 x 85.1	64.4 x 66.1 x 85.1	64.4 x 66.1 x 85.1
	Fully Integrated	-	-	-	-	-	-
<b>Stacking quantity (pcs)</b>	Freestanding	6 (2 baskets) / 4 (3rd basket)	6 (2 baskets) / 4 (3rd basket)	6 (2 baskets) / 4 (3rd basket)	6 (2 baskets) / 4 (3rd basket)	4	6 (2 baskets) / 4 (3rd basket)
	Semi-Integrated	6	6	6	6	6	6
	Fully Integrated	-	-	-	-	-	-
<b>Gross/Net weight (kg)(5)</b>	Freestanding	49 /46 - 56 /53	49 /46 - 56 /53	49 /46 - 56 /53	49 /46 - 56 /53	56 /53	49 /46 - 56 /53
	Semi-Integrated	43 /41	43 /41	43 /41	43 /41	43 /41	43 /41
	Fully Integrated	-	-	-	-	-	-
<b>Container loading (40"HC/ 40" / 20")</b>		162 /108 /54	162 /108 /54	162 /108 /54	162 /108 /54	162 /108 /54	162 /108 /54

**Notes**

(o) : Optional

(\*) : See roadmap for availability

(\*\*) : Auto programme can be chosen instead of Intensive programme (with turbidity sensor).

(1) : Turbo Fan feature & 3rd basket (& Aquazone for w/o diverter models) are default for 15 PS models.

For w/o diverter models; 3rd basket can be selected only with Aquazone

(2) : Modular cutlery basket for 12/13 PS must be selected with wine stem support & spoon rack. Also wine stem support & spoon rack can be selected only for mesh type upper basket option.

(3) : Can be selected for lower basket with fixed type or with 4 foldable wire.

(4) : Based on the tests performed with Eco programme in accordance with European Household Dishwasher Performance Standards

(5) : Gross/Net Weights are shown as reference in the table. It should be calculated based on the final product features created from this general spect table.

A3 SERIES 60cm Models BUILT-IN DISHWASHERS		A31	A32	A33	A34	A35	A36
<b>General Characteristics</b>							
<b>Number of place settings (PS)(1)</b>	12 PS (2 baskets)	Default	Default	Default	Default	-	Default
	13 PS (2 baskets)	(o)	(o)	(o)	(o)	-	(o)
	13 PS (2 baskets + 3rd rack)	(o)	(o)	(o)	(o)	-	(o)
	14 PS (2 baskets + 3rd rack)	-	-	-	-	Default	-
	15 PS (2 baskets + 3rd rack)	(o) with Turbo fan	(o) with Turbo fan	(o)	(o)	-	(o)
<b>Number of programmes</b>	6+	8+	6+	8+	8+	8+	8+
<b>Temperatures (°C)</b>	Auto-30-40-50-60-65-70	Auto-30-40-50-60-65-70	Auto-30-40-50-60-65-70	Auto-30-40-50-60-65-70	Auto-30-40-50-60-65-70	Auto-30-40-50-60-65-70	Auto-30-40-50-60-65-70
<b>Control type</b>	Default	Button Control	Button Control	Button Control	Button Control	Button Control	Button Control
	Option	Touch Control	Touch Control	Touch Control	Touch Control	Touch Control	Touch Control
<b>Hidden heating element</b>		Yes	Yes	Yes	Yes	Yes	Yes
<b>Filter type</b>	Metal	Default	Default	Default	Default	Default	Default
	Plastic	(o)	(o)	-	-	-	-
<b>Tub material</b>		Stainless Steel	Stainless Steel	Stainless Steel	Stainless Steel	Stainless Steel	Stainless Steel
<b>Turbidity sensor (Smart Wash)</b>		Yes	Yes	Yes	Yes	Yes	Yes
<b>Drying system</b>	Mini Active	Default	Default	-	-	-	-
	Super Active	(o)	(o)	-	-	-	-
	Turbo	(o)	(o)	Default	Default	Default	Default
<b>Electrical Diverter system</b>		Yes	Yes	Yes	Yes	Yes	Yes
<b>Overflow &amp; leakage protection</b>		Yes	Yes	Yes	Yes	Yes	Yes
<b>Heater protection</b>		Yes	Yes	Yes	Yes	Yes	Yes
<b>Circulation pump</b>	Asynchronous	Yes	Yes	-	-	-	-
	BLDC	-	-	Yes	Yes	Yes	Yes
<b>Auto Door</b>		-	-	Yes	Yes	Yes	-
<b>Water Box</b>		-	-	-	-	Yes	-
<b>Triple &amp; Direct Wash*</b>		(o)	(o)	(o)	(o)	(o)	(o)
<b>Aquazone</b>		-	-	-	-	-	-
<b>Wi-fi*</b>		(o)	(o)	(o)	(o)	(o)	(o)
<b>New Indoor Design</b>		(o)	(o)	(o)	(o)	(o)	(o)
<b>Sliding Door</b>		-	-	-	-	-	-
<b>Ion Tech</b>		(o)	(o)	(o)	(o)	(o)	(o)
<b>Uvon Tech*</b>		-	-	(o)	(o)	(o)	(o)
<b>Interior light</b>	one spot	(o)	(o)	(o)	(o)	(o)	(o)
	four spot	(o)	(o)	(o)	(o)	(o)	(o)
<b>Available Aesthetics*</b>	Freestanding	Angel, Carya, Daisy, Erica	Angel, Carya, Daisy, Erica	Angel, Carya, Daisy, Erica	Angel, Carya, Daisy, Erica	Angel, Carya, Daisy, Erica	Angel, Carya, Daisy, Erica
	Semi-Integrated	Daisy, Gardenya, Gardenya (Inox add-on)	Daisy, Gardenya, Gardenya (Inox add-on)	Daisy, Gardenya, Gardenya (Inox add-on)	Daisy, Gardenya, Gardenya (Inox add-on)	Daisy, Gardenya, Gardenya (Inox add-on)	Daisy, Gardenya, Gardenya (Inox add-on)
	Fully Integrated	-	-	-	-	-	-
<b>Appliance Color Options</b>		Black, Dark Gray, Dark Inox, Dark Silver, Inox, White	Black, Dark Gray, Dark Inox, Dark Silver, Inox, White	Black, Dark Gray, Dark Inox, Dark Silver, Inox, White	Black, Dark Gray, Dark Inox, Dark Silver, Inox, White	Black, Dark Gray, Dark Inox, Dark Silver, Inox, White	Black, Dark Gray, Dark Inox, Dark Silver, Inox, White
<b>Programmes</b>							
<b>Prewash</b>		Yes	Yes	-	-	-	-
<b>Mini 14' (Jet Wash)</b>		Yes	Yes	Yes	Yes	Yes	Yes
<b>Quick 30' 40°C</b>		Yes	Yes	Yes	Yes	Yes	Yes
<b>Eco (Standard Programme)</b>		Yes	Yes	Yes	Yes	Yes	Yes
<b>Super 50' 65°C (Quick Clean)</b>		Yes	Yes	Yes	Yes	Yes	Yes
<b>Dual Pro Wash 60°C</b>		-	-	Yes	Yes	Yes	Yes
<b>Auto Delicate 30°C - 50°C</b>		-	Yes	-	Yes	Yes	Yes
<b>Auto Normal 50°C - 60°C / Auto Flex 50°C - 60°C</b>		-	Yes	-	Yes	-	Yes
<b>Auto Intensive 60°C - 70°C</b>		Yes	Yes	Yes	Yes	Yes (50°C - 70°C)	Yes
<b>Eco 5.4 lt / Save+ 5.4 lt</b>		-	-	-	-	Yes	-
<b>User Interface</b>							
<b>Start/Pause button</b>		Yes	Yes	Yes	Yes	Yes	Yes
<b>DISPLAY TYPE [Mini / Large] (delay start, remaining time)</b>		Large: Icon LED	Large: Icon LED	Large: Icon LED	Large: Icon LED	Large: Icon LED	Large: Icon LED
<b>Display Color</b>	Default	Red	Red	Red	Red	Red	Red
	Option	White	White	White	White	White	White
<b>Prewash button</b>		-	-	-	-	-	-
<b>Programme selection button</b>		Yes	Yes	Yes	Yes	Yes	Yes
<b>Delay timer option</b>	3hr,6hr,9hr	-	-	-	-	-	-
	1-2-3-...-19hr	-	-	-	-	-	-
	1-2-3-...-24hr	Yes	Yes	Yes	Yes	Yes	Yes
<b>Eco Wash - Half load option</b>	1 mode	-	-	-	-	-	-
	3 modes	Yes	Yes	Yes	Yes	Yes	Yes
<b>Tablet option</b>		Yes	Yes	Yes	Yes	Yes	Yes
<b>Extra Hygiene option</b>		Yes	Yes	Yes	Yes	Yes	Yes
<b>Extra Rinse option</b>		Yes	Yes	-	-	-	-
<b>Extra Drying option</b>		Yes	Yes	-	-	-	Yes
<b>Extra Silent option (Silent Wash)</b>		-	-	Yes	Yes	Yes	Yes
<b>Extra Fast option</b>		-	-	Yes	Yes	Yes	Yes

A3 SERIES 60cm Models BUILT-IN DISHWASHERS		A31	A32	A33	A34	A35	A36
<b>User Interface</b>							
Energy Save option		-	-	Yes	Yes	Yes	-
Rinse-aid indicator		Yes	Yes	Yes	Yes	Yes	Yes
Salt indicator		Yes	Yes	Yes	Yes	Yes	Yes
Washing cycle indicators		Yes	Yes	Yes	Yes	Yes	Yes
End of cycle indicator		Yes	Yes	Yes	Yes	Yes	Yes
Child Lock		Yes	Yes	Yes	Yes	Yes	Yes
Buzzer		Yes (Touch Control) / (o) Button Control	Yes (Touch Control) / (o) Button Control	Yes	Yes	Yes	Yes (Touch Control) / (o) Button Control
<b>Baskets &amp; Accessories</b>							
3rd basket [EasyTray, EcoTray or Comfort Tray]	12 PS	-	-	-	-	-	-
	13 PS	(o)	(o)	(o)	(o)	-	(o)
	14 PS	-	-	-	-	Yes	-
	15 PS	Yes	Yes	Yes	Yes	-	Yes
Upper basket type [mesh type / peg type]	(o)	(o)	(o)	(o)	Peg	(o)	
Adjustable upper basket [empty/ loaded 2 level / loaded 3 level*]	(o)	(o)	(o)	(o)	(o)	(o)	
Number of mug shelves	2 (std) / 4 (o)	2 (std) / 4 (o)	2 (std) / 4 (o)	2 (std) / 4 (o)	4	2 (std) / 4 (o)	
Adjustable mug shelves	Yes (peg type) / (o) (mesh type)	Yes (peg type) / (o) (mesh type)	Yes (peg type) / (o) (mesh type)	Yes (peg type) / (o) (mesh type)	Yes	Yes (peg type) / (o) (mesh type)	
Mug shelves with soft touch rubber (only with peg type basket)	(o)	(o)	(o)	(o)	(o)	(o)	
Foldable racks on upper basket (only with peg type basket)	fixed (std) / 2 or 4 or 6 (o)	fixed (std) / 2 or 4 or 6 (o)	fixed (std) / 2 or 4 or 6 (o)	fixed (std) / 2 or 4 or 6 (o)	4 or 6 (o)	fixed (std) / 2 or 4 or 6 (o)	
Foldable racks on lower basket	(o)	(o)	(o)	(o)	Yes	(o)	
Upper basket handle type [No / Wire / Plastic / Metal]	(o)	(o)	(o)	(o)	(o)	(o)	
Lower basket handle type [No / Wire / Plastic / Metal]	(o)	(o)	(o)	(o)	(o)	(o)	
Removable cutlery basket (Single piece)	(o)(12/13ps) / No(15ps)	(o)(12/13ps) / No(15ps)	(o)(12/13ps) / No(15ps)	(o)(12/13ps) / No(15ps)	(o)(12/13ps) / No(15ps)	-	(o)(12/13ps) / No(15ps)
Removable cutlery basket (Universal)	No(12/13ps) / (o)(15ps)	No(12/13ps) / (o)(15ps)	No(12/13ps) / (o)(15ps)	No(12/13ps) / (o)(15ps)	(o)	(o)	No(12/13ps) / (o)(15ps)
Removable cutlery basket (Modular) (2)	(o)	(o)	(o)	(o)	(o)	(o)	(o)
Removable cutlery basket (Sliding) (3)	(o)(12/13ps) / No(15ps)	(o)(12/13ps) / No(15ps)	(o)(12/13ps) / No(15ps)	(o)(12/13ps) / No(15ps)	(o)(12/13ps) / No(15ps)	-	(o)(12/13ps) / No(15ps)
Multi functional kit (Extra mug shelves + higher rear part on lower basket)	(o)	(o)	(o)	(o)	(o)	(o)	(o)
Bottle holder on lower basket	(o)	(o)	(o)	(o)	(o)	(o)	(o)
Wine stem support & Spoon rack on upper basket (2)	(o)	(o)	(o)	(o)	(o)	-	(o)
Wine glass holder on lower basket	(o) with 4 foldable racks	(o) with 4 foldable racks	(o) with 2 or more foldable racks	(o) with 4 foldable racks	(o) with 4 foldable racks	(o) with 4 foldable racks	(o) with 4 foldable racks
Top nozzle	fixed type with 2 baskets	(o)	(o)	(o)	(o)	-	(o)
	rotating type	Default with 3rd basket	Default with 3rd basket	Default with 3rd basket	Default with 3rd basket	Default	Default with 3rd basket
Aquastop external hose	(o)	(o)	(o)	(o)	(o)	(o)	(o)
Antibacterial filter	(o)	(o)	(o)	(o)	(o)	(o)	(o)
Anti-siphon system	(o)	(o)	(o)	(o)	(o)	(o)	(o)
<b>Technical Data (4)</b>							
Sound level (dB(A) re 1 pW)	12 PS	57 / 54 / 52 / 49 / 47 / 45	57 / 54 / 52 / 49 / 47 / 45	46 / 44	46 / 44	-	49 / 47 / 45 / 44 / 42 / 41
	13 PS	57 / 54 / 52 / 49 / 47 / 45	57 / 54 / 52 / 49 / 47 / 45	46 / 44	46 / 44	-	49 / 47 / 45 / 44 / 42 / 41
	14 PS	-	-	-	-	44	-
	15 PS	49 / 47 / 45	49 / 47 / 45	44 / 42	44 / 42	-	49 / 47 / 45 / 44 / 42 / 41 / 39
Energy efficiency class		A++	A++	A+++	A+++	A+++ -20%	A+++
Energy efficiency index	12 PS	55,8	55,8	49,7	49,7	-	49,7
	13 PS	55,6	55,6	49,8	49,8	-	49,8
	14 PS	-	-	-	-	39,6	-
	15 PS	55,8	55,8	49,8	49,8	-	49,8
Cleaning efficiency class		A	A	A	A	A	A
Cleaning efficiency index		1,13	1,13	1,13	1,13	1,13	1,13
Drying efficiency class		A	A	A	A	A	A
Drying efficiency index		1,09	1,09	1,09	1,09	1,09	1,09
Standard programme water consumption (lt / cycle)	Default	9,0	9,0	9,0	9,0	9,0	9,0
	with Aquazone	-	-	-	-	-	-
Annual water consumption (lt / year)	Default	2520	2520	2520	2520	2520	2520
	with Aquazone	-	-	-	-	-	-
Duration of the standard programme (min)	Default	171	171	239	239	207	270
	with Aquazone	-	-	-	-	-	-
Standard programme energy consumption (kWh / cycle)	12 PS	0,907	0,907	0,807	0,807	-	0,807
	13 PS	0,917	0,917	0,821	0,821	-	0,821
	14 PS	-	-	-	-	0,660	-
	15 PS	0,949	0,949	0,846	0,846	-	0,846
Annual energy consumption (kWh / year)	12 PS	258	258	230	230	-	230
	13 PS	261	261	234	234	-	234
	14 PS	-	-	-	-	189	-
	15 PS	270	270	241	241	-	241
Off mode power consumption (W)		0,50	0,50	0,50	0,50	0,50	0,50
Left-on mode power consumption (W)		1,00	1,00	1,00	1,00	1,00	1,00
Network standby mode power consumption (W)		N/A	N/A	N/A	N/A	N/A	N/A



A3 SERIES 60cm Models BUILT-IN DISHWASHERS		A31	A32	A33	A34	A35	A36
<b>Technical Data (4)</b>							
<b>Duration of left-on mode (min)</b>		15	15	15	15	15	15
<b>Power rating (W) / Heating element (W)</b>		1900 / 1800	1900 / 1800	1900 / 1800	1900 / 1800	1900 / 1800	1900 / 1800
<b>Plug Type</b>		EU / UK / Swiss / Italy / Israel / AU/NZ / China / Argentina / S.Africa	EU / UK / Swiss / Italy / Israel / AU/NZ / China / Argentina / S.Africa	EU / UK / Swiss / Italy / Israel / AU/NZ / China / Argentina / S.Africa	EU / UK / Swiss / Italy / Israel / AU/NZ / China / Argentina / S.Africa	EU / UK / Swiss / Italy / Israel / AU/NZ / China / Argentina / S.Africa	EU / UK / Swiss / Italy / Israel / AU/NZ / China / Argentina / S.Africa
<b>Power cord length (cm)</b>		165	165	165	165	165	165
<b>Water inlet hose length (cm)</b>	Default	147	147	147	147	147	147
	with Aquastop ext. hose	170	170	170	170	170	170
<b>Water outlet hose length (cm)</b>		200	200	200	200	200	200
<b>Voltage (V) / Frequency (Hz) / Fuse Rating (A)</b>		220-240 / 50 / 10	220-240 / 50 / 10	220-240 / 50 / 10	220-240 / 50 / 10	220-240 / 50 / 10	220-240 / 50 / 10
<b>Water pressure range (bar)</b>		0,3 - 10	0,3 - 10	0,3 - 10	0,3 - 10	0,3 - 10	0,3 - 10
<b>Dimensions</b>							
<b>Height (cm)</b>	Freestanding	85,0	85,0	85,0	85,0	85,0	85,0
	Semi-Integrated	82,0	82,0	82,0	82,0	82,0	82,0
	Fully Integrated	-	-	-	-	-	-
<b>Width (cm)</b>		59,8	59,8	59,8	59,8	59,8	59,8
<b>Depth (cm)</b>	Freestanding	59,8	59,8	59,8	59,8	59,8	59,8
	Semi-Integrated	57,0	57,0	57,0	57,0	57,0	57,0
	Fully Integrated	-	-	-	-	-	-
<b>Height adjustment (+cm)</b>	Freestanding	2	2	2	2	2	2
	Semi-Integrated	5	5	5	5	5	5
	Fully Integrated	-	-	-	-	-	-
<b>Adjustable Plinth for undertable usage (mm) Undertable</b>		(o) (80 or/and 130)	(o) (80 or/and 130)	(o) (80 or/and 130)	(o) (80 or/and 130)	(o) (80 or/and 130)	(o) (80 or/and 130)
<b>Possible adjustment of the plinth Undertable (horizontal / vertical) (mm / mm)</b>		0-100 / 0-50	0-100 / 0-50	0-100 / 0-50	0-100 / 0-50	0-100 / 0-50	0-100 / 0-50
<b>Height without worktop (cm) Undertable</b>		82,0	82,0	82,0	82,0	82,0	82,0
<b>Decorative panel height (max) (cm) Semi-Integrated</b>		59,7	59,7	59,7	59,7	59,7	59,7
<b>Plinth height (min) (cm) Semi-Integrated</b>		8	8	8	8	8	8
<b>Plinth depth (cm) Semi-Integrated</b>		3 - 8	3 - 8	3 - 8	3 - 8	3 - 8	3 - 8
<b>Packed dimensions (Width x Depth x Height) (cm)</b>	Freestanding	64.4 x 66.1 x 88.1	64.4 x 66.1 x 88.1	64.4 x 66.1 x 88.1	64.4 x 66.1 x 88.1	64.4 x 66.1 x 88.1	64.4 x 66.1 x 88.1
	Semi-Integrated	64.4 x 66.1 x 85.1	64.4 x 66.1 x 85.1	64.4 x 66.1 x 85.1	64.4 x 66.1 x 85.1	64.4 x 66.1 x 85.1	64.4 x 66.1 x 85.1
	Fully Integrated	-	-	-	-	-	-
<b>Stacking quantity (pcs)</b>	Freestanding	6 (2 baskets) / 4 (3rd basket)	6 (2 baskets) / 4 (3rd basket)	6 (2 baskets) / 4 (3rd basket)	6 (2 baskets) / 4 (3rd basket)	4	6 (2 baskets) / 4 (3rd basket)
	Semi-Integrated	6	6	6	6	6	6
	Fully Integrated	-	-	-	-	-	-
<b>Gross/Net weight (kg)(5)</b>	Freestanding	49 /46 - 56 /53	49 /46 - 56 /53	49 /46 - 56 /53	49 /46 - 56 /53	56 /53	49 /46 - 56 /53
	Semi-Integrated	43 /41	43 /41	43 /41	43 /41	43 /41	43 /41
	Fully Integrated	-	-	-	-	-	-
<b>Container loading (40"HC/ 40"/ 20")</b>		162 /108 /54	162 /108 /54	162 /108 /54	162 /108 /54	162 /108 /54	162 /108 /54

Notes

(o) : Optional

(\*) : See roadmap for availability

(\*\*) : Auto programme can be chosen instead of Intensive programme (with turbidity sensor).

(1) : Turbo Fan feature & 3rd basket (& Aquazone for w/o diverter models) are default for 15 PS models.

For w/o diverter models; 3rd basket can be selected only with Aquazone

(2) : Modular cutlery basket for 12/13 PS must be selected with wine stem support & spoon rack. Also wine stem support & spoon rack can be selected only for mesh type upper basket option.

(3) : Can be selected for lower basket with fixed type or with 4 foldable wire.

(4) : Based on the tests performed with Eco programme in accordance with European Household Dishwasher Performance Standards

(5) : Gross/Net Weights are shown as reference in the table. It should be calculated based on the final product features created from this general spec table.

A4 SERIES 60cm Models BUILT-IN DISHWASHERS		A41	A42	A43	A44	A45
<b>General Characteristics</b>						
<b>Number of place settings (PS)(l)</b>	12 PS (2 baskets)	Default	Default	Default	Default	-
	13 PS (2 baskets)	(o)	(o)	(o)	(o)	-
	13 PS (2 baskets + 3rd rack)	(o)	(o)	(o)	(o)	-
	14 PS (2 baskets + 3rd rack)	-	-	-	-	Default
	15 PS (2 baskets + 3rd rack)	(o) with Turbo fan	(o) with Turbo fan	(o)	(o)	-
<b>Number of programmes</b>	6+	7+	10+	10+	10+	
<b>Temperatures (°C)</b>	Auto-40-50-60-65-70	Auto-30-40-50-60-65-70	Auto-30-40-50-60-65-70	Auto-30-40-50-60-70	Auto-30-40-50-60-65-70	
<b>Control type</b>	Default	Touch Control	Touch Control	Touch Control	Touch Control	Touch Control
	Option	-	-	-	-	-
<b>Hidden heating element</b>	Yes	Yes	Yes	Yes	Yes	
<b>Filter type</b>	Metal	Default	Default	Default	Default	Default
	Plastic	(o)	(o)	-	-	-
<b>Tub material</b>	Stainless Steel	Stainless Steel	Stainless Steel	Stainless Steel	Stainless Steel	
<b>Turbidity sensor (Smart Wash)</b>	Yes	Yes	Yes	Yes	Yes	
<b>Drying system</b>	Mini Active	Default	Default	-	-	-
	Super Active	(o)	(o)	-	-	-
	Turbo	(o)	(o)	Default	Default	Default
<b>Electrical Diverter system</b>	Yes	Yes	Yes	Yes	Yes	
<b>Overflow &amp; leakage protection</b>	Yes	Yes	Yes	Yes	Yes	
<b>Heater protection</b>	Yes	Yes	Yes	Yes	Yes	
<b>Circulation pump</b>	Asynchronous	-	-	-	-	-
	BLDC	Yes	Yes	Yes	Yes	Yes
<b>Auto Door</b>	-	-	-	Yes	Yes	
<b>Water Box</b>	-	-	-	-	Yes	
<b>Triple &amp; Direct Wash*</b>	(o)	(o)	(o)	(o)	(o)	
<b>Aquazone</b>	-	-	-	-	-	
<b>Wi-fi*</b>	(o)	(o)	(o)	(o)	(o)	
<b>New Indoor Design</b>	(o)	(o)	(o)	(o)	(o)	
<b>Sliding Door</b>	-	-	-	-	-	
<b>Ion Tech</b>	(o)	(o)	(o)	(o)	(o)	
<b>Uvon Tech*</b>	-	-	-	(o)	(o)	
<b>InfoLED</b>	1,0	-	-	-	-	-
	2,0 (Floor Indicator)	-	-	-	-	-
<b>Interior light</b>	one spot	(o)	(o)	(o)	(o)	(o)
	four spot	(o)	(o)	(o)	(o)	(o)
<b>Available Aesthetics*</b>	Freestanding	Angel, Carya, Daisy, Erica	Angel, Carya, Daisy, Erica	Angel, Carya, Daisy, Erica	Angel, Carya, Daisy, Erica	Angel, Carya, Daisy, Erica
	Semi-Integrated	Daisy, Gardenya, Gardenya (Inox add-on)	Daisy, Gardenya, Gardenya (Inox add-on)	Daisy, Gardenya, Gardenya (Inox add-on)	Daisy, Gardenya, Gardenya (Inox add-on)	Daisy, Gardenya, Gardenya (Inox add-on)
	Fully Integrated	-	-	-	-	-
<b>Appliance Color Options</b>	Black, Dark Gray, Dark Inox, Dark Silver, Inox, White	Black, Dark Gray, Dark Inox, Dark Silver, Inox, White	Black, Dark Gray, Dark Inox, Dark Silver, Inox, White	Black, Dark Gray, Dark Inox, Dark Silver, Inox, White	Black, Dark Gray, Dark Inox, Dark Silver, Inox, White	
<b>Programmes</b>						
<b>Prewash</b>	Yes	Yes	Yes	Yes	Yes	
<b>Mini 14' (Jet Wash)</b>	-	Yes	Yes	Yes	Yes	
<b>Quick 30' 40°C</b>	Yes	Yes	Yes	Yes	Yes	
<b>Eco (Standard Programme)</b>	Yes	Yes	Yes	Yes	Yes	
<b>Super 50' 65°C (Quick Clean)</b>	Yes	Yes	Yes	Yes	Yes	
<b>Daily 60°C / Hybrid Wash 60°C</b>	-	-	Yes	Yes	-	
<b>Dual Pro Wash 60°C</b>	Yes	Yes	Yes	Yes	Yes	
<b>Auto Delicate 30°C - 50°C</b>	-	-	Yes	Yes	Yes	
<b>Auto Normal 50°C - 60°C / Auto Flex 50°C - 60°C</b>	-	-	Yes	Yes	Yes	
<b>Auto Intensive 60°C - 70°C</b>	Yes	Yes	Yes	Yes	-	
<b>Steam Wash</b>	-	-	-	-	Yes	
<b>Eco 5.4 lt / Save+ 5.4 lt</b>	-	-	-	-	Yes	
<b>User Interface</b>						
<b>Start/Pause button</b>	Yes	Yes	Yes	Yes	Yes	
<b>DISPLAY TYPE [Mini / Large] (delay start, remaining time)</b>	Large: Full Touch + Icon LED	Large: Full Touch + Icon LED	Large: Full Touch + Icon LED	Large: Full Touch + Icon LED	Large: Full Touch + Icon LED	
<b>Display Color</b>	Default	White	White	White	White	
	Option	-	-	-	-	
<b>Programme selection button</b>	Yes	Yes	Yes	Yes	Yes	

A4 SERIES 60cm Models BUILT-IN DISHWASHERS		A41	A42	A43	A44	A45
<b>User Interface</b>						
Delay timer option	3hr,6hr,9hr	-	-	-	-	-
	1-2-3-...-19hr	-	-	-	-	-
	1-2-3-...-24hr	Yes	Yes	Yes	Yes	Yes
Eco Wash - Half load option	1 mode	-	-	-	-	-
	3 modes	Yes	Yes	Yes	Yes	Yes
Tablet option		Yes	Yes	Yes	Yes	Yes
Extra Hygiene option		Yes	Yes	Yes	Yes	Yes
Extra Rinse option		-	-	-	-	-
Extra Drying option		-	Yes	Yes	Yes	Yes
Extra Silent option (Silent Wash)		-	Yes	Yes	Yes	Yes
Extra Fast option		Yes	Yes	Yes	Yes	Yes
Energy Save option		-	-	-	Yes	Yes
Rinse-aid indicator		Yes	Yes	Yes	Yes	Yes
Salt indicator		Yes	Yes	Yes	Yes	Yes
Washing cycle indicators		Yes	Yes	Yes	Yes	Yes
End of cycle indicator		Yes	Yes	Yes	Yes	Yes
Child Lock		Yes	Yes	Yes	Yes	Yes
Buzzer		Yes	Yes	Yes	Yes	Yes
<b>Baskets &amp; Accessories</b>						
3rd basket [EasyTray, EcoTray or Comfort Tray]	12 PS	-	-	-	-	-
	13 PS	(o)	(o)	(o)	(o)	-
	14 PS	-	-	-	-	Yes
	15 PS	Yes	Yes	Yes	Yes	-
Upper basket type [mesh type / peg type]		(o)	(o)	(o)	(o)	Peg
Adjustable upper basket [empty/ loaded 2 level / loaded 3 level*]		(o)	(o)	(o)	(o)	(o)
Number of mug shelves		2 (std) / 4 (o)	2 (std) / 4 (o)	2 (std) / 4 (o)	2 (std) / 4 (o)	4
Adjustable mug shelves		Yes (peg type) / (mesh type) (o)	Yes (peg type) / (mesh type) (o)	Yes (peg type) / (mesh type) (o)	Yes (peg type) / (mesh type) (o)	Yes
Mug shelves with soft touch rubber (only with peg type basket)		(o)	(o)	(o)	(o)	(o)
Foldable racks on upper basket (only with peg type basket)		fixed (std) / 2 or 4 or 6 (o)	fixed (std) / 2 or 4 or 6 (o)	fixed (std) / 2 or 4 or 6 (o)	fixed (std) / 2 or 4 or 6 (o)	4 or 6 (o)
Foldable racks on lower basket		(o)	(o)	(o)	(o)	Yes
Upper basket handle type [No / Wire / Plastic / Metal]		(o)	(o)	(o)	(o)	(o)
Lower basket handle type [No / Wire / Plastic / Metal]		(o)	(o)	(o)	(o)	(o)
Removable cutlery basket (Single piece)		(o)(12/13ps) / No(15ps)	(o)(12/13ps) / No(15ps)	(o)(12/13ps) / No(15ps)	(o)(12/13ps) / No(15ps)	-
Removable cutlery basket (Universal)		No(12/13ps) / (o)(15ps)	No(12/13ps) / (o)(15ps)	No(12/13ps) / (o)(15ps)	No(12/13ps) / (o)(15ps)	(o)
Removable cutlery basket (Modular) (2)		(o)	(o)	(o)	(o)	(o)
Removable cutlery basket (Sliding) (3)		(o)(12/13ps) / No(15ps)	(o)(12/13ps) / No(15ps)	(o)(12/13ps) / No(15ps)	(o)(12/13ps) / No(15ps)	-
Multi functional kit (Extra mug shelves + higher rear part on lower basket)		(o)	(o)	(o)	(o)	(o)
Bottle holder on lower basket		(o)	(o)	(o)	(o)	(o)
Wine stem support & Spoon rack on upper basket (2)		(o)	(o)	(o)	(o)	-
Wine glass holder on lower basket		(o) with 4 foldable racks	(o) with 4 foldable racks	(o) with 4 foldable racks	(o) with 4 foldable racks	(o) with 4 foldable racks
Top nozzle	fixed type with 2 baskets	(o)	(o)	(o)	(o)	-
	rotating type	Default with 3rd basket	Default with 3rd basket	Default with 3rd basket	Default with 3rd basket	Default
Aquastop external hose		(o)	(o)	(o)	(o)	(o)
Antibacterial filter		(o)	(o)	(o)	(o)	(o)
Anti-siphon system		(o)	(o)	(o)	(o)	(o)
<b>Technical Data (4)</b>						
Sound level (dB(A) re 1 pW)	12 PS	47	46 / 44	49 / 47 / 45 / 44 / 42 / 41	46 / 44	-
	13 PS	47	46 / 44	49 / 47 / 45 / 44 / 42 / 41	46 / 44	-
	14 PS	-	-	-	-	44
	15 PS	47	44 / 42	49 / 47 / 45 / 44 / 42 / 41 / 39	44 / 42	-
Energy efficiency class		A++	A++	A+++	A+++	A+++ -20%
Energy efficiency index	12 PS	55,8	55,8	49,7	49,7	-
	13 PS	55,6	55,6	49,8	49,8	-
	14 PS	-	-	-	-	39,6
	15 PS	55,9	55,8	49,8	49,8	-
Cleaning efficiency class		A	A	A	A	A
Cleaning efficiency index		1,13	1,13	1,13	1,13	1,13
Drying efficiency class		A	A	A	A	A
Drying efficiency index		1,09	1,09	1,09	1,09	1,09

A4 SERIES 60cm Models BUILT-IN DISHWASHERS		A41	A42	A43	A44	A45
<b>Technical Data (4)</b>						
Standard programme water consumption (lt / cycle)	Default	9,0	9,0	9,0	9,0	9,0
	with Aquazone	-	-	-	-	-
Annual water consumption (lt / year)	Default	2520	2520	2520	2520	2520
	with Aquazone	-	-	-	-	-
Duration of the standard programme (min)	Default	159	239	270	239	207
	with Aquazone	-	-	-	-	-
Standard programme energy consumption (kWh / cycle)	12 PS	0,906	0,907	0,807	0,807	-
	13 PS	0,917	0,917	0,821	0,821	-
	14 PS	-	-	-	-	0,660
	15 PS	0,949	0,949	0,846	0,846	-
Annual energy consumption (kWh / year)	12 PS	258	258	230	230	-
	13 PS	261	261	234	234	-
	14 PS	-	-	-	-	189
	15 PS	270	270	241	241	-
Off mode power consumption (W)		0,50	0,50	0,50	0,50	0,50
Left-on mode power consumption (W)		1,00	1,00	1,00	1,00	1,00
Network standby mode power consumption (W)		N/A	N/A	N/A	N/A	N/A
Duration of left-on mode (min)		15	15	15	15	15
Power rating (W) / Heating element (W)		1900 / 1800	1900 / 1800	1900 / 1800	1900 / 1800	1900 / 1800
Plug Type		EU / UK / Swiss / Italy / Israel / AU/NZ / China / Argentina / S.Africa	EU / UK / Swiss / Italy / Israel / AU/NZ / China / Argentina / S.Africa	EU / UK / Swiss / Italy / Israel / AU/NZ / China / Argentina / S.Africa	EU / UK / Swiss / Italy / Israel / AU/NZ / China / Argentina / S.Africa	EU / UK / Swiss / Italy / Israel / AU/NZ / China / Argentina / S.Africa
Power cord length (cm)		165	165	165	165	165
Water inlet hose length (cm)	Default	147	147	147	147	147
	with Aquastop ext. hose	170	170	170	170	170
Water outlet hose length (cm)		200	200	200	200	200
Voltage (V) / Frequency (Hz) / Fuse Rating (A)		220-240 / 50 / 10	220-240 / 50 / 10	220-240 / 50 / 10	220-240 / 50 / 10	220-240 / 50 / 10
Water pressure range (bar)		0,3 - 10	0,3 - 10	0,3 - 10	0,3 - 10	0,3 - 10
<b>Dimensions</b>						
Height (cm)	Freestanding	85,0	85,0	85,0	85,0	85,0
	Semi-Integrated	82,0	82,0	82,0	82,0	82,0
	Fully Integrated	-	-	-	-	-
Width (cm)		59,8	59,8	59,8	59,8	59,8
Depth (cm)	Freestanding	59,8	59,8	59,8	59,8	59,8
	Semi-Integrated	57,0	57,0	57,0	57,0	57,0
	Fully Integrated	-	-	-	-	-
Height adjustment (+cm)	Freestanding	2	2	2	2	2
	Semi-Integrated	5	5	5	5	5
	Fully Integrated	-	-	-	-	-
Adjustable Plinth for undertable usage (mm) Undertable		(o) (80 or/and 130)	(o) (80 or/and 130)	(o) (80 or/and 130)	(o) (80 or/and 130)	(o) (80 or/and 130)
Possible adjustment of the plinth Undertable (horizontal / vertical) (mm / mm)		0-100 / 0-50	0-100 / 0-50	0-100 / 0-50	0-100 / 0-50	0-100 / 0-50
Height without worktop (cm) Undertable		82,0	82,0	82,0	82,0	82,0
Decorative panel height (max) (cm) Semi-Integrated		59,7	59,7	59,7	59,7	59,7
Plinth height (min) (cm) Semi-Integrated		8	8	8	8	8
Plinth depth (cm) Semi-Integrated		3 - 8	3 - 8	3 - 8	3 - 8	3 - 8
Packed dimensions (Width x Depth x Height) (cm)	Freestanding	64.4 x 66.1 x 88.1	64.4 x 66.1 x 88.1	64.4 x 66.1 x 88.1	64.4 x 66.1 x 88.1	64.4 x 66.1 x 88.1
	Semi-Integrated	64.4 x 66.1 x 85.1	64.4 x 66.1 x 85.1	64.4 x 66.1 x 85.1	64.4 x 66.1 x 85.1	64.4 x 66.1 x 85.1
	Fully Integrated	-	-	-	-	-
Stacking quantity (pcs)	Freestanding	6 (2 baskets) / 4 (3rd basket)	6 (2 baskets) / 4 (3rd basket)	6 (2 baskets) / 4 (3rd basket)	6 (2 baskets) / 4 (3rd basket)	4
	Semi-Integrated	6	6	6	6	6
	Fully Integrated	-	-	-	-	-
Gross/Net weight (kg)(5)	Freestanding	57 /55 - 64 /62	57 /55 - 64 /62	57 /55 - 64 /62	49 /46 - 56 /53	56 /53
	Semi-Integrated	43 /41	43 /41	43 /41	43 /41	43 /41
	Fully Integrated	-	-	-	-	-
Container loading (40"HC/ 40" / 20")		162 /108 /54	162 /108 /54	162 /108 /54	162 /108 /54	162 /108 /54

Notes

(o) : Optional

(\*) : See roadmap for availability

(\*\*) : Auto programme can be chosen instead of Intensive programme (with turbidity sensor).

(1) : Turbo Fan feature & 3rd basket (& Aquazone for w/o diverter models) are default for 15 PS models.

For w/o diverter models; 3rd basket can be selected only with Aquazone

(2) : Modular cutlery basket for 12/13 PS must be selected with wine stem support & spoon rack. Also wine stem support & spoon rack can be selected only for mesh type upper basket option.

(3) : Can be selected for lower basket with fixed type or with 4 foldable wire.

(4) : Based on the tests performed with Eco programme in accordance with European Household Dishwasher Performance Standards

(5) : Gross/Net Weights are shown as reference in the table. It should be calculated based on the final product features created from this general spect table.



X SERIES 60cm Models BUILT-IN DISHWASHERS		X11	X1A	X12	X1B	X13	X1C	X14	X1D	X15	X1E	X16	X1F
<b>General Characteristics</b>													
<b>Number of place settings (PS)(1)</b>	12 PS (2 baskets)	Default	Default	Default	Default	Default	Default	Default	Default	Default	Default	Default	Default
	13 PS (2 baskets)	(o)	(o)	(o)	(o)	(o)	(o)	(o)	(o)	(o)	(o)	(o)	(o)
	13 PS (2 baskets + 3rd rack)	(o) with Aquazone	(o) with Aquazone	(o) with Aquazone	(o) with Aquazone	(o) with Aquazone	(o) with Aquazone	(o) with Aquazone	(o) with Aquazone	(o) with Aquazone	(o) with Aquazone	(o) with Aquazone	(o) with Aquazone
	14 PS (2 baskets + 3rd rack)	-	-	-	-	-	-	-	-	-	-	-	-
	15 PS (2 baskets + 3rd rack)	-	-	-	-	-	-	-	-	-	-	-	-
<b>Number of programmes</b>		2	2	3	3	4	4	5	5	6	6	7	7
<b>Temperatures (°C)</b>		50-65	50-65	50-65	50-65	40-50-65	40-50-65	40-50-65-70	40-50-65-70	40-50-65-70	40-50-65-70	40-50-65-70	40-50-65-70
<b>Control type</b>	Default	Knob Control	Knob Control	Knob Control	Knob Control	Knob Control	Knob Control	Knob Control	Knob Control	Knob Control	Knob Control	Knob Control	Knob Control
	Option	-	-	-	-	-	-	-	-	-	-	-	-
<b>Hidden heating element</b>		Yes	Yes	Yes	Yes	Yes	Yes	Yes	Yes	Yes	Yes	Yes	Yes
<b>Filter type</b>	Metal	Default	Default	Default	Default	Default	Default	Default	Default	Default	Default	Default	Default
	Plastic	(o)	(o)	(o)	(o)	(o)	(o)	(o)	(o)	(o)	(o)	(o)	(o)
<b>Tub material</b>		Stainless Steel	Stainless Steel	Stainless Steel	Stainless Steel	Stainless Steel	Stainless Steel	Stainless Steel	Stainless Steel	Stainless Steel	Stainless Steel	Stainless Steel	Stainless Steel
<b>Turbidity sensor (Smart Wash)</b>		-	-	-	-	-	-	-	-	-	-	-	-
<b>Drying system</b>	Mini Active	Default	Default	Default	Default	Default	Default	Default	Default	Default	Default	Default	Default
	Super Active	(o)	(o)	(o)	(o)	(o)	(o)	(o)	(o)	(o)	(o)	(o)	(o)
	Turbo	-	-	-	-	-	-	-	-	-	-	-	-
<b>Overflow &amp; leakage protection</b>		Yes	Yes	Yes	Yes	Yes	Yes	Yes	Yes	Yes	Yes	Yes	Yes
<b>Heater protection</b>		Yes	Yes	Yes	Yes	Yes	Yes	Yes	Yes	Yes	Yes	Yes	Yes
<b>Circulation pump</b>	Asynchronous	Yes	Yes	Yes	Yes	Yes	Yes	Yes	Yes	Yes	Yes	Yes	Yes
<b>Aquazone</b>		(o)	(o)	(o)	(o)	(o)	(o)	(o)	(o)	(o)	(o)	(o)	(o)
<b>New Indoor Design</b>		(o)	(o)	(o)	(o)	(o)	(o)	(o)	(o)	(o)	(o)	(o)	(o)
<b>Available Aesthetics</b>	Freestanding	Belis, Camelia, Flora, Giada, Odysseus, Smyrna, Tigris, Viola	Belis, Camelia, Flora, Giada, Odysseus, Smyrna, Tigris, Viola	Belis, Camelia, Flora, Giada, Odysseus, Smyrna, Tigris, Viola	Belis, Camelia, Flora, Giada, Odysseus, Smyrna, Tigris, Viola	Belis, Camelia, Flora, Giada, Odysseus, Smyrna, Tigris, Viola	Belis, Camelia, Flora, Giada, Odysseus, Smyrna, Tigris, Viola	Belis, Camelia, Flora, Giada, Odysseus, Smyrna, Tigris, Viola	Belis, Camelia, Flora, Giada, Odysseus, Smyrna, Tigris, Viola	Belis, Camelia, Flora, Giada, Odysseus, Smyrna, Tigris, Viola	Belis, Camelia, Flora, Giada, Odysseus, Smyrna, Tigris, Viola	Belis, Camelia, Flora, Giada, Odysseus, Smyrna, Tigris, Viola	Belis, Camelia, Flora, Giada, Odysseus, Smyrna, Tigris, Viola
	Semi-Integrated	Camelia, Silva, Silva (Inox add-on)	Camelia, Silva, Silva (Inox add-on)	Camelia, Silva, Silva (Inox add-on)	Camelia, Silva, Silva (Inox add-on)	Camelia, Silva, Silva (Inox add-on)	Camelia, Silva, Silva (Inox add-on)	Camelia, Silva, Silva (Inox add-on)	Camelia, Silva, Silva (Inox add-on)	Camelia, Silva, Silva (Inox add-on)	Camelia, Silva, Silva (Inox add-on)	Camelia, Silva, Silva (Inox add-on)	Camelia, Silva, Silva (Inox add-on)
	Fully Integrated	-	-	-	-	-	-	-	-	-	-	-	-
<b>Appliance Color Options</b>		Black, Dark Gray, Dark Inox, Dark Silver, Inox, White	Black, Dark Gray, Dark Inox, Dark Silver, Inox, White	Black, Dark Gray, Dark Inox, Dark Silver, Inox, White	Black, Dark Gray, Dark Inox, Dark Silver, Inox, White	Black, Dark Gray, Dark Inox, Dark Silver, Inox, White	Black, Dark Gray, Dark Inox, Dark Silver, Inox, White	Black, Dark Gray, Dark Inox, Dark Silver, Inox, White	Black, Dark Gray, Dark Inox, Dark Silver, Inox, White	Black, Dark Gray, Dark Inox, Dark Silver, Inox, White	Black, Dark Gray, Dark Inox, Dark Silver, Inox, White	Black, Dark Gray, Dark Inox, Dark Silver, Inox, White	Black, Dark Gray, Dark Inox, Dark Silver, Inox, White
<b>Programmes</b>													
<b>Prewash</b>		-	-	-	-	-	-	-	-	Yes	Yes	Yes	Yes
<b>Quick 30' 40°C</b>		-	-	-	-	Yes	Yes	Yes	Yes	Yes	Yes	Yes	Yes
<b>Eco (Standard Programme)</b>		Yes	Yes	Yes	Yes	Yes	Yes	Yes	Yes	Yes	Yes	Yes	Yes
<b>Super 50' 65°C (Quick Clean)</b>		-	-	Yes	Yes	Yes	Yes	Yes	Yes	Yes	Yes	Yes	Yes
<b>Delicate 40°C</b>		-	-	-	-	-	-	-	-	-	-	Yes	Yes
<b>Hygiene 70°C</b>		-	-	-	-	-	-	Yes	Yes	Yes	Yes	Yes	Yes
<b>Intensive 65°C</b>		Yes	Yes	Yes	Yes	Yes	Yes	Yes	Yes	Yes	Yes	Yes	Yes
<b>Start/Pause button</b>		Yes	Yes	Yes	Yes	Yes	Yes	Yes	Yes	Yes	Yes	Yes	Yes
<b>DISPLAY TYPE (delay start, remaining time)</b>		-	LED	-	LED	-	LED	-	LED	-	LED	-	LED
<b>Display Color</b>	Default	-	Red	-	Red	-	Red	-	Red	-	Red	-	Red
	Option	-	-	-	-	-	-	-	-	-	-	-	-
<b>Programme selection button</b>		Knob	Knob	Knob	Knob	Knob	Knob	Knob	Knob	Knob	Knob	Knob	Knob
<b>Delay timer option</b>	3hr,6hr,9hr	Yes	-	Yes	-	Yes	-	Yes	-	Yes	-	Yes	-
	1-2-3-...-19hr	-	Yes	-	Yes	-	Yes	-	Yes	-	Yes	-	Yes
	1-2-3-...-24hr	-	-	-	-	-	-	-	-	-	-	-	-
<b>Eco Wash - Half load option</b>	1 mode	Yes	Yes	Yes	Yes	Yes	Yes	Yes	Yes	Yes	Yes	Yes	Yes
	3 modes	-	-	-	-	-	-	-	-	-	-	-	-
<b>Rinse-aid indicator</b>		Yes	Yes	Yes	Yes	Yes	Yes	Yes	Yes	Yes	Yes	Yes	Yes
<b>Salt indicator</b>		Yes	Yes	Yes	Yes	Yes	Yes	Yes	Yes	Yes	Yes	Yes	Yes
<b>Washing cycle indicators</b>		Yes	Yes	Yes	Yes	Yes	Yes	Yes	Yes	Yes	Yes	Yes	Yes
<b>End of cycle indicator</b>		Yes	Yes	Yes	Yes	Yes	Yes	Yes	Yes	Yes	Yes	Yes	Yes
<b>Child Lock</b>		-	Yes	-	Yes	-	Yes	-	Yes	-	Yes	-	Yes
<b>Baskets &amp; Accessories</b>													
<b>3rd basket [EasyTray, EcoTray or Comfort Tray]</b>	12 PS	-	-	-	-	-	-	-	-	-	-	-	-
	13 PS	(o)	(o)	(o)	(o)	(o)	(o)	(o)	(o)	(o)	(o)	(o)	(o)
	14 PS	-	-	-	-	-	-	-	-	-	-	-	-
	15 PS	-	-	-	-	-	-	-	-	-	-	-	-
<b>Upper basket type [mesh type / peg type]</b>		(o)	(o)	(o)	(o)	(o)	(o)	(o)	(o)	(o)	(o)	(o)	(o)
<b>Adjustable upper basket [empty/ loaded 2 level / loaded 3 level*]</b>		(o)	(o)	(o)	(o)	(o)	(o)	(o)	(o)	(o)	(o)	(o)	(o)
<b>Number of mug shelves</b>		2 (std)/4 (o)	2 (std)/4 (o)	2 (std)/4 (o)	2 (std)/4 (o)	2 (std)/4 (o)	2 (std)/4 (o)	2 (std)/4 (o)	2 (std)/4 (o)	2 (std)/4 (o)	2 (std)/4 (o)	2 (std)/4 (o)	2 (std)/4 (o)

X SERIES 60cm Models BUILT-IN DISHWASHERS		X11	X1A	X12	X1B	X13	X1C	X14	X1D	X15	X1E	X16	X1F
<b>Baskets &amp; Accessories</b>													
Adjustable mug shelves		Yes (peg type) / (o) (mesh type)	Yes (peg type) / (o) (mesh type)	Yes (peg type) / (o) (mesh type)	Yes (peg type) / (o) (mesh type)	Yes (peg type) / (o) (mesh type)	Yes (peg type) / (o) (mesh type)	Yes (peg type) / (o) (mesh type)	Yes (peg type) / (o) (mesh type)	Yes (peg type) / (o) (mesh type)	Yes (peg type) / (o) (mesh type)	Yes (peg type) / (o) (mesh type)	Yes (peg type) / (o) (mesh type)
Mug shelves with soft touch rubber (only with peg type basket)		(o)	(o)	(o)	(o)	(o)	(o)	(o)	(o)	(o)	(o)	(o)	(o)
Foldable racks on upper basket (only with peg type basket)		fixed (std) / 2 or 4 or 6 (o)	fixed (std) / 2 or 4 or 6 (o)	fixed (std) / 2 or 4 or 6 (o)	fixed (std) / 2 or 4 or 6 (o)	fixed (std) / 2 or 4 or 6 (o)	fixed (std) / 2 or 4 or 6 (o)	fixed (std) / 2 or 4 or 6 (o)	fixed (std) / 2 or 4 or 6 (o)	fixed (std) / 2 or 4 or 6 (o)	fixed (std) / 2 or 4 or 6 (o)	fixed (std) / 2 or 4 or 6 (o)	fixed (std) / 2 or 4 or 6 (o)
Foldable racks on lower basket		(o)	(o)	(o)	(o)	(o)	(o)	(o)	(o)	(o)	(o)	(o)	(o)
Upper basket handle type [No / Wire / Plastic / Metal]		(o)	(o)	(o)	(o)	(o)	(o)	(o)	(o)	(o)	(o)	(o)	(o)
Lower basket handle type [No / Wire / Plastic / Metal]		(o)	(o)	(o)	(o)	(o)	(o)	(o)	(o)	(o)	(o)	(o)	(o)
Removable cutlery basket (Single piece)		(o)	(o)	(o)	(o)	(o)	(o)	(o)	(o)	(o)	(o)	(o)	(o)
Removable cutlery basket (Universal)		-	-	-	-	-	-	-	-	-	-	-	-
Removable cutlery basket (Modular) (2)		(o)	(o)	(o)	(o)	(o)	(o)	(o)	(o)	(o)	(o)	(o)	(o)
Removable cutlery basket (Sliding) (3)		(o)	(o)	(o)	(o)	(o)	(o)	(o)	(o)	(o)	(o)	(o)	(o)
Multi functional kit (Extra mug shelves + higher rear part on lower basket)		(o)	(o)	(o)	(o)	(o)	(o)	(o)	(o)	(o)	(o)	(o)	(o)
Bottle holder on lower basket		(o)	(o)	(o)	(o)	(o)	(o)	(o)	(o)	(o)	(o)	(o)	(o)
Wine stem support & Spoon rack on upper basket (2)		(o)	(o)	(o)	(o)	(o)	(o)	(o)	(o)	(o)	(o)	(o)	(o)
Wine glass holder on lower basket		(o) with 4 foldable racks	(o) with 4 foldable racks	(o) with 4 foldable racks	(o) with 4 foldable racks	(o) with 4 foldable racks	(o) with 4 foldable racks	(o) with 4 foldable racks	(o) with 4 foldable racks	(o) with 4 foldable racks	(o) with 4 foldable racks	(o) with 4 foldable racks	(o) with 4 foldable racks
Top nozzle	fixed type with 2 baskets	(o) with Aquazone	(o) with Aquazone	(o) with Aquazone	(o) with Aquazone	(o) with Aquazone	(o) with Aquazone	(o) with Aquazone	(o) with Aquazone	(o) with Aquazone	(o) with Aquazone	(o) with Aquazone	(o) with Aquazone
	rotating type	Default with 3rd basket	Default with 3rd basket	Default with 3rd basket	Default with 3rd basket	Default with 3rd basket	Default with 3rd basket	Default with 3rd basket	Default with 3rd basket	Default with 3rd basket	Default with 3rd basket	Default with 3rd basket	Default with 3rd basket
AquaStop external hose		(o)	(o)	(o)	(o)	(o)	(o)	(o)	(o)	(o)	(o)	(o)	(o)
Antibacterial filter		(o)	(o)	(o)	(o)	(o)	(o)	(o)	(o)	(o)	(o)	(o)	(o)
Anti-siphon system		(o)	(o)	(o)	(o)	(o)	(o)	(o)	(o)	(o)	(o)	(o)	(o)
<b>Technical Data (4)</b>													
Sound level (dB(A) re 1 pW)	12 PS	57 / 54 / 52 / 49 / 47 / 45	57 / 54 / 52 / 49 / 47 / 45	57 / 54 / 52 / 49 / 47 / 45	57 / 54 / 52 / 49 / 47 / 45	57 / 54 / 52 / 49 / 47 / 45	57 / 54 / 52 / 49 / 47 / 45	57 / 54 / 52 / 49 / 47 / 45	57 / 54 / 52 / 49 / 47 / 45	57 / 54 / 52 / 49 / 47 / 45	57 / 54 / 52 / 49 / 47 / 45	57 / 54 / 52 / 49 / 47 / 45	57 / 54 / 52 / 49 / 47 / 45
	13 PS	57 / 54 / 52 / 49 / 47 / 45	57 / 54 / 52 / 49 / 47 / 45	57 / 54 / 52 / 49 / 47 / 45	57 / 54 / 52 / 49 / 47 / 45	57 / 54 / 52 / 49 / 47 / 45	57 / 54 / 52 / 49 / 47 / 45	57 / 54 / 52 / 49 / 47 / 45	57 / 54 / 52 / 49 / 47 / 45	57 / 54 / 52 / 49 / 47 / 45	57 / 54 / 52 / 49 / 47 / 45	57 / 54 / 52 / 49 / 47 / 45	57 / 54 / 52 / 49 / 47 / 45
	14 PS	-	-	-	-	-	-	-	-	-	-	-	-
	15 PS	-	-	-	-	-	-	-	-	-	-	-	-
Energy efficiency class		A++	A++	A++	A++	A++	A++	A++	A++	A++	A++	A++	A++
Energy efficiency index	12 PS	55,8	55,8	55,8	55,8	55,8	55,8	55,8	55,8	55,8	55,8	55,8	55,8
	13 PS	55,6	55,6	55,6	55,6	55,6	55,6	55,6	55,6	55,6	55,6	55,6	55,6
	14 PS	-	-	-	-	-	-	-	-	-	-	-	-
	15 PS	-	-	-	-	-	-	-	-	-	-	-	-
Cleaning efficiency class		A	A	A	A	A	A	A	A	A	A	A	A
Cleaning efficiency index		1,13	1,13	1,13	1,13	1,13	1,13	1,13	1,13	1,13	1,13	1,13	1,13
Drying efficiency class		A	A	A	A	A	A	A	A	A	A	A	A
Drying efficiency index		1,09	1,09	1,09	1,09	1,09	1,09	1,09	1,09	1,09	1,09	1,09	1,09
Standard programme water consumption (lt / cycle)	Default	12,0	12,0	12,0	12,0	12,0	12,0	12,0	12,0	12,0	12,0	12,0	12,0
	with Aquazone	9,0	9,0	9,0	9,0	9,0	9,0	9,0	9,0	9,0	9,0	9,0	9,0
Annual water consumption (lt / year)	Default	3360	3360	3360	3360	3360	3360	3360	3360	3360	3360	3360	3360
	with Aquazone	2520	2520	2520	2520	2520	2520	2520	2520	2520	2520	2520	2520
Duration of the standard programme (min)	Default	165	165	165	165	165	165	165	165	165	165	165	165
	with Aquazone	221	221	221	221	221	221	221	221	221	221	221	221
Standard programme energy consumption (kWh / cycle)	12 PS	0,900	0,900	0,900	0,900	0,900	0,900	0,900	0,900	0,900	0,900	0,900	0,900
	13 PS	0,910	0,910	0,910	0,910	0,910	0,910	0,910	0,910	0,910	0,910	0,910	0,910
	14 PS	-	-	-	-	-	-	-	-	-	-	-	-
	15 PS	-	-	-	-	-	-	-	-	-	-	-	-
Annual energy consumption (kWh / year)	12 PS	258	258	258	258	258	258	258	258	258	258	258	258
	13 PS	261	261	261	261	261	261	261	261	261	261	261	261
	14 PS	-	-	-	-	-	-	-	-	-	-	-	-
	15 PS	-	-	-	-	-	-	-	-	-	-	-	-
Off mode power consumption (W)		0,50	0,50	0,50	0,50	0,50	0,50	0,50	0,50	0,50	0,50	0,50	0,50
Left-on mode power consumption (W)		1,00	1,00	1,00	1,00	1,00	1,00	1,00	1,00	1,00	1,00	1,00	1,00
Network standby mode power consumption (W)		N/A	N/A	N/A	N/A	N/A	N/A	N/A	N/A	N/A	N/A	N/A	N/A
Duration of left-on mode (min)		N/A	N/A	N/A	N/A	N/A	N/A	N/A	N/A	N/A	N/A	N/A	N/A
Power rating (W) / Heating element (W)		1900 / 1800	1900 / 1800	1900 / 1800	1900 / 1800	1900 / 1800	1900 / 1800	1900 / 1800	1900 / 1800	1900 / 1800	1900 / 1800	1900 / 1800	1900 / 1800
Plug Type EU / UK / Swiss / Italy / Israel / AU/NZ / China / Argentina / S.Africa													
Power cord length (cm)		165	165	165	165	165	165	165	165	165	165	165	165
Water inlet hose length (cm)	Default	147	147	147	147	147	147	147	147	147	147	147	147
	with AquaStop ext. hose	170	170	170	170	170	170	170	170	170	170	170	170
Water outlet hose length (cm)		200	200	200	200	200	200	200	200	200	200	200	200
Voltage (V) / Frequency (Hz) / Fuse Rating (A)		220-240 / 50 / 10	220-240 / 50 / 10	220-240 / 50 / 10	220-240 / 50 / 10	220-240 / 50 / 10	220-240 / 50 / 10	220-240 / 50 / 10	220-240 / 50 / 10	220-240 / 50 / 10	220-240 / 50 / 10	220-240 / 50 / 10	220-240 / 50 / 10
Water pressure range (bar)		0,3 - 10	0,3 - 10	0,3 - 10	0,3 - 10	0,3 - 10	0,3 - 10	0,3 - 10	0,3 - 10	0,3 - 10	0,3 - 10	0,3 - 10	0,3 - 10

X SERIES 60cm Models BUILT-IN DISHWASHERS		X11	X1A	X12	X1B	X13	X1C	X14	X1D	X15	X1E	X16	X1F
<b>Dimensions</b>													
<b>Height (cm)</b>	Freestanding	85,0	85,0	85,0	85,0	85,0	85,0	85,0	85,0	85,0	85,0	85,0	85,0
	Semi-Integrated	82,0	82,0	82,0	82,0	82,0	82,0	82,0	82,0	82,0	82,0	82,0	82,0
	Fully Integrated	-	-	-	-	-	-	-	-	-	-	-	-
<b>Width (cm)</b>		59,8	59,8	59,8	59,8	59,8	59,8	59,8	59,8	59,8	59,8	59,8	59,8
<b>Depth (cm)</b>	Freestanding	59,8	59,8	59,8	59,8	59,8	59,8	59,8	59,8	59,8	59,8	59,8	59,8
	Semi-Integrated	57,0	57,0	57,0	57,0	57,0	57,0	57,0	57,0	57,0	57,0	57,0	57,0
	Fully Integrated	-	-	-	-	-	-	-	-	-	-	-	-
<b>Height adjustment (+cm)</b>	Freestanding	2	2	2	2	2	2	2	2	2	2	2	2
	Semi-Integrated	5	5	5	5	5	5	5	5	5	5	5	5
	Fully Integrated	-	-	-	-	-	-	-	-	-	-	-	-
<b>Adjustable Plinth for undertable usage (mm) Undertable</b>		(o) (80 or/ and 130)	(o) (80 or/ and 130)	(o) (80 or/ and 130)	(o) (80 or/ and 130)	(o) (80 or/ and 130)	(o) (80 or/ and 130)	(o) (80 or/ and 130)	(o) (80 or/ and 130)	(o) (80 or/ and 130)	(o) (80 or/ and 130)	(o) (80 or/ and 130)	(o) (80 or/ and 130)
<b>Possible adjustment of the plinth Undertable (horizontal / vertical) (mm / mm)</b>		0-100 / 0-50	0-100 / 0-50	0-100 / 0-50	0-100 / 0-50	0-100 / 0-50	0-100 / 0-50	0-100 / 0-50	0-100 / 0-50	0-100 / 0-50	0-100 / 0-50	0-100 / 0-50	0-100 / 0-50
<b>Height without worktop (cm) Undertable</b>		82,0	82,0	82,0	82,0	82,0	82,0	82,0	82,0	82,0	82,0	82,0	82,0
<b>Decorative panel height (max) (cm) Semi-Integrated</b>		59,7	59,7	59,7	59,7	59,7	59,7	59,7	59,7	59,7	59,7	59,7	59,7
<b>Plinth height (min) (cm) Semi-Integrated</b>		8	8	8	8	8	8	8	8	8	8	8	8
<b>Plinth depth (cm) Semi-Integrated</b>		3 - 8	3 - 8	3 - 8	3 - 8	3 - 8	3 - 8	3 - 8	3 - 8	3 - 8	3 - 8	3 - 8	3 - 8
<b>Packed dimensions (Width x Depth x Height) (cm)</b>	Freestanding	64.4 x 66.1 x 88.1											
	Semi-Integrated	64.4 x 66.1 x 85.1											
	Fully Integrated	-	-	-	-	-	-	-	-	-	-	-	-
<b>Stacking quantity (pcs)</b>	Freestanding	6 (2 baskets) / 4 (3rd basket)											
	Semi-Integrated	6	6	6	6	6	6	6	6	6	6	6	6
	Fully Integrated	-	-	-	-	-	-	-	-	-	-	-	-
<b>Gross/Net weight (kg)(5)</b>	Freestanding	49 /46 - 56 /53											
	Semi-Integrated	43 /41	43 /41	43 /41	43 /41	43 /41	43 /41	43 /41	43 /41	43 /41	43 /41	43 /41	43 /41
	Fully Integrated	-	-	-	-	-	-	-	-	-	-	-	-
<b>Container loading (40"HC / 40" / 20")</b>		162 /108 /54											

Notes

(o) : Optional

(\*\*) : Auto programme can be chosen instead of Intensive programme (with turbidity sensor)

(1) : Turbo Fan feature & 3rd basket (& Aquazone for w/o diverter models) are default for 15 PS models.

For w/o diverter models; 3rd basket can be selected only with Aquazone.

Touch control is available with negative LCD display (Aran and Daphne only)"

(2) : Modular cutlery basket for 12/13 PS must be selected with wine stem support & spoon rack. Also wine stem support & spoon rack can be selected only for mesh type upper basket option.

(3) : Can be selected for lower basket with fixed type or with 4 foldable wire.

(4) : Based on the tests performed with Eco programme in accordance with European Household Dishwasher Performance Standards

(5) : Gross/Net Weights are shown as reference in the table. It should be calculated based on the final product features created from this general spec table.

Y SERIES 60cm Models BUILT-IN DISHWASHERS		Y11	Y1A	Y12	Y1B	Y13	Y1C	Y14	Y1D	Y15	Y1E	Y1F	Y21	Y22	Y23	Y24	Y25	Y26			
<b>General Characteristics</b>																					
<b>Number of place settings (PS)(1)</b>	12 PS (2 baskets)	Default																			
	13 PS (2 baskets)	(o)																			
	13 PS (2 baskets + 3rd rack)	(o) with Aquazone											(o)								
	14 PS (2 baskets + 3rd rack)	-																			
	15 PS (2 baskets + 3rd rack)	(o) with Aquazone and Turbo fan											(o) with Turbo fan					(o)			
<b>Number of programmes</b>	2	2	3	3	4	4	5	5	6	6	7	6	7	8	9+	9+	9+				
<b>Temperatures (°C)</b>	50-65				40-50-65							40-50-60-65	40-50-65	40-50-60-65			Auto-30-40-50-60-65-70				
<b>Control type</b>	Default	Button Control																			
	Option	-	-	-	-	-	-	-	-	-	-	-	-	-	-	-	-	-	-	-	
<b>Hidden heating element</b>	Yes	Yes	Yes	Yes	Yes	Yes	Yes	Yes	Yes	Yes	Yes	Yes	Yes	Yes	Yes	Yes	Yes	Yes	Yes		
<b>Filter type</b>	Metal	Default																			
	Plastic	(o)	(o)	(o)	(o)	(o)	(o)	(o)	(o)	(o)	(o)	(o)	(o)	(o)	(o)	(o)	(o)	(o)	-	-	
<b>Tub material</b>	Stainless Steel																				
<b>Turbidity sensor (Smart Wash)</b>	(o)	(o)	(o)	(o)	(o)	(o)	(o)	(o)	(o)	(o)	(o)	(o)	(o)	(o)	(o)	(o)	(o)	Yes	Yes	Yes	
<b>Drying system</b>	Mini Active	Default																			
	Super Active	(o)	(o)	(o)	(o)	(o)	(o)	(o)	(o)	(o)	(o)	(o)	(o)	(o)	(o)	(o)	(o)	(o)	-	-	
	Turbo	(o)	(o)	(o)	(o)	(o)	(o)	(o)	(o)	(o)	(o)	(o)	(o)	(o)	(o)	(o)	(o)	(o)	Default		
<b>Electrical Diverter system</b>	-	-	-	-	-	-	-	-	-	-	-	-	Yes	Yes	Yes	Yes	Yes	Yes	Yes		
<b>Overflow &amp; leakage protection</b>	Yes	Yes	Yes	Yes	Yes	Yes	Yes	Yes	Yes	Yes	Yes	Yes	Yes	Yes	Yes	Yes	Yes	Yes	Yes		
<b>Heater protection</b>	Yes	Yes	Yes	Yes	Yes	Yes	Yes	Yes	Yes	Yes	Yes	Yes	Yes	Yes	Yes	Yes	Yes	Yes	Yes		
<b>Circulation pump</b>	Asynchronous	Yes	Yes	Yes	Yes	Yes	Yes	Yes	Yes	Yes	Yes	Yes	Yes	Yes	Yes	Yes	Yes	-	-		
	BLDC	-	-	-	-	-	-	-	-	-	-	-	-	-	-	-	-	Yes	Yes		
<b>Auto Door</b>	-	-	-	-	-	-	-	-	-	-	-	-	-	-	-	-	-	Yes	-		
<b>Water Box</b>	-	-	-	-	-	-	-	-	-	-	-	-	-	-	-	-	-	-	-		
<b>Triple &amp; Direct Wash</b>	-	-	-	-	-	-	-	-	-	-	-	-	-	-	-	(o)*	(o)	-	-		
<b>Aquazone</b>	(o)	(o)	(o)	(o)	(o)	(o)	(o)	(o)	(o)	(o)	(o)	(o)	(o)	(o)	(o)	(o)	(o)	(o)	(o)		
<b>Wi-fi</b>	-	-	-	-	-	-	-	-	-	-	-	-	-	-	-	-	-	-	-		
<b>New Indoor Design</b>	(o)	(o)	(o)	(o)	(o)	(o)	(o)	(o)	(o)	(o)	(o)	(o)	(o)	(o)	(o)	(o)	(o)	(o)	(o)		
<b>Ion Tech</b>	(o)	(o)	(o)	(o)	(o)	(o)	(o)	(o)	(o)	(o)	(o)	(o)	(o)	(o)	(o)	(o)	(o)	(o)	(o)		
<b>Uvon Tech</b>	-	-	-	-	-	-	-	-	-	-	-	-	-	-	-	-	-	-	-		
<b>InfoLED</b>	1,0	-	-	-	-	-	-	-	-	-	-	-	-	-	-	-	-	-	-		
	2,0 (Floor Indicator)	-	-	-	-	-	-	-	-	-	-	-	-	-	-	-	-	-	-		
<b>Interior light</b>	one spot	(o)	(o)	(o)	(o)	(o)	(o)	(o)	(o)	(o)	(o)	(o)	(o)	(o)	(o)	(o)	(o)	(o)	(o)		
	four spot	(o)	(o)	(o)	(o)	(o)	(o)	(o)	(o)	(o)	(o)	(o)	(o)	(o)	(o)	(o)	(o)	(o)	(o)		
<b>Available Aesthetics</b>	Freestanding	Belis Y, Camelia Y, Flora Y, Tigris Y, Viola Y																			
	Semi-Integrated	Camelia Y, Silva Y, Silva Y (Inox add-on)																			
	Fully Integrated	-	-	-	-	-	-	-	-	-	-	-	-	-	-	-	-	-	-	-	
<b>Appliance Color Options</b>	Black, Dark Gray, Dark Inox, Dark Silver, Inox, White																				
<b>Programmes</b>																					
<b>Prewash</b>	-	-	-	-	-	-	-	-	-	Yes	Yes	Yes	Yes	Yes	Yes	Yes	Yes	Yes	Yes		
<b>Mini 14' (Jet Wash)</b>	-	-	-	-	-	-	-	-	-	-	-	-	-	-	-	-	-	Yes	Yes		
<b>Quick 30' 40°C</b>	-	-	-	-	Yes	Yes	Yes	Yes	Yes	Yes	Yes	Yes	Yes	Yes	Yes	Yes	Yes	Yes	Yes		
<b>Eco (Standard Programme)</b>	Yes	Yes	Yes	Yes	Yes	Yes	Yes	Yes	Yes	Yes	Yes	Yes	Yes	Yes	Yes	Yes	Yes	Yes	Yes		
<b>Super 50' 65°C (Quick Clean)</b>	-	-	Yes	Yes	Yes	Yes	Yes	Yes	Yes	Yes	Yes	Yes	Yes	Yes	Yes	Yes	Yes	Yes	Yes		
<b>Super 55' 60°C</b>	-	-	-	-	-	-	-	-	-	-	-	-	-	-	-	-	-	-	-		
<b>Delicate 40°C</b>	-	-	-	-	-	-	Yes	Yes	Yes	Yes	Yes	Yes	Yes	Yes	Yes	-	-	-	-		
<b>Normal 55°C / Flexi Wash 55°C</b>	-	-	-	-	-	-	-	-	-	-	-	-	-	-	-	Yes	-	-	-		
<b>Daily 60°C / Hybrid Wash 60°C</b>	-	-	-	-	-	-	-	-	-	-	-	Yes	-	Yes	Yes	Yes	-	-	-		
<b>Dual Pro Wash 60°C</b>	-	-	-	-	-	-	-	-	-	-	-	-	-	-	-	-	-	Yes	Yes		
<b>Hygiene 60°C</b>	-	-	-	-	-	-	-	-	-	-	-	-	-	-	-	-	-	-	-		
<b>Hygiene 70°C</b>	-	-	-	-	-	-	-	-	-	-	-	-	-	-	-	-	-	-	Yes		
<b>Intensive 65°C</b>	Yes	Yes	Yes	Yes	Yes	Yes	Yes	Yes	Yes	Yes	Yes	Yes	Yes	Yes	Yes	Yes	Yes	-	-		
<b>Auto**</b>	(o)	(o)	(o)	(o)	(o)	(o)	(o)	(o)	(o)	(o)	(o)	(o)	(o)	(o)	(o)	(o)	(o)	-	-		
<b>Auto Delicate 30°C - 50°C</b>	-	-	-	-	-	-	-	-	-	-	-	-	-	-	-	-	-	Yes	-		
<b>Auto Normal 50°C - 60°C / Auto Flex 50°C - 60°C</b>	-	-	-	-	-	-	-	-	-	-	-	-	-	-	-	-	-	Yes	-		
<b>Auto Intensive 60°C - 70°C</b>	-	-	-	-	-	-	-	-	-	-	-	-	-	-	-	-	-	Yes	Yes		
<b>Steam Wash</b>	-	-	-	-	-	-	-	-	-	-	-	-	-	-	-	-	-	Yes	Yes		
<b>User Interface</b>																					
<b>Start/Pause button</b>	Yes	Yes	Yes	Yes	Yes	Yes	Yes	Yes	Yes	Yes	Yes	Yes	Yes	Yes	Yes	Yes	Yes	Yes	Yes		
<b>DISPLAY TYPE (delay start, remaining time)</b>	-	LED	-	LED	-	LED	-	LED	-	LED	LED	LED	LED	LED	LED	LED	LED	LED	LED		
<b>Display Color</b>	Default	-	Red	-	Red	-	Red	-	Red	-	Red	Red	Red	Red	Red	Red	Red	Red	Red		
	Option	-	-	-	-	-	-	-	-	-	-	-	-	-	-	-	-	-	-		
<b>Programme selection button</b>	Yes	Yes	Yes	Yes	Yes	Yes	Yes	Yes	Yes	Yes	Yes	Yes	Yes	Yes	Yes	Yes	Yes	Yes	Yes		
<b>Delay timer option</b>	3hr,6hr,9hr	Yes	-	Yes	-	Yes	-	Yes	-	Yes	-	Yes	-	Yes	-	Yes	-	Yes	-		
	1-2-3-...-19hr	-	Yes	-	Yes	-	Yes	-	Yes	-	Yes	-	Yes	-	Yes	-	Yes	-	Yes		
	1-2-3-...-24hr	-	-	-	-	-	-	-	-	-	-	-	-	-	-	-	-	-	-		



Y SERIES 60cm Models BUILT-IN DISHWASHERS		Y11	Y1A	Y12	Y1B	Y13	Y1C	Y14	Y1D	Y15	Y1E	Y1F	Y21	Y22	Y23	Y24	Y25	Y26		
<b>User Interface</b>																				
Eco Wash - Half load option	1 mode	Yes	Yes	Yes	Yes	Yes	Yes	Yes	Yes	Yes	Yes	Yes	-	-	-	-	-	-		
	3 modes	-	-	-	-	-	-	-	-	-	-	-	Yes	Yes	Yes	Yes	Yes	Yes		
Tablet option		-	Yes	-	Yes	-	Yes	-	Yes	-	Yes	Yes	Yes	Yes	Yes	Yes	Yes	Yes		
Extra Hygiene option		-	Yes	-	Yes	-	Yes	-	Yes	-	Yes	Yes	Yes	Yes	Yes	Yes	Yes	Yes		
Extra Rinse option		-	Yes	-	Yes	-	Yes	-	Yes	-	Yes	Yes	Yes	Yes	Yes	Yes	Yes	Yes		
Extra Drying option		-	Yes	-	Yes	-	Yes	-	Yes	-	Yes	Yes	Yes	Yes	Yes	Yes	Yes	Yes		
Extra Silent option (Silent Wash)		-	-	-	-	-	-	-	-	-	-	-	-	-	-	-	Yes	Yes		
Extra Fast option		-	-	-	-	-	-	-	-	-	-	-	-	-	-	-	Yes	Yes		
Energy Save option		-	-	-	-	-	-	-	-	-	-	-	-	-	-	-	Yes	-		
Rinse-aid indicator		Yes	Yes	Yes	Yes	Yes	Yes	Yes	Yes	Yes	Yes	Yes	Yes	Yes	Yes	Yes	Yes	Yes		
Salt indicator		Yes	Yes	Yes	Yes	Yes	Yes	Yes	Yes	Yes	Yes	Yes	Yes	Yes	Yes	Yes	Yes	Yes		
Washing cycle indicators		Yes	Yes	Yes	Yes	Yes	Yes	Yes	Yes	Yes	Yes	Yes	Yes	Yes	Yes	Yes	Yes	Yes		
End of cycle indicator		Yes	Yes	Yes	Yes	Yes	Yes	Yes	Yes	Yes	Yes	Yes	Yes	Yes	Yes	Yes	Yes	Yes		
Child Lock		-	Yes	-	Yes	-	Yes	-	Yes	-	Yes	Yes	Yes	Yes	Yes	Yes	Yes	Yes		
Buzzer		-	-	-	-	-	-	-	-	-	-	-	-	-	-	-	Yes	-		
<b>Baskets &amp; Accessories</b>																				
3rd basket [EasyTray, EcoTray or Comfort Tray]	12 PS	-	-	-	-	-	-	-	-	-	-	-	-	-	-	-	-	-		
	13 PS	(o)	(o)	(o)	(o)	(o)	(o)	(o)	(o)	(o)	(o)	(o)	(o)	(o)	(o)	(o)	(o)	(o)		
	14 PS	-	-	-	-	-	-	-	-	-	-	-	-	-	-	-	-	-		
	15 PS	Yes	Yes	Yes	Yes	Yes	Yes	Yes	Yes	Yes	Yes	Yes	Yes	Yes	Yes	Yes	Yes	Yes		
Upper basket type [mesh type / peg type]		(o)	(o)	(o)	(o)	(o)	(o)	(o)	(o)	(o)	(o)	(o)	(o)	(o)	(o)	(o)	(o)	(o)		
Adjustable upper basket [empty/ loaded 2 level / loaded 3 level*]		(o)	(o)	(o)	(o)	(o)	(o)	(o)	(o)	(o)	(o)	(o)	(o)	(o)	(o)	(o)	(o)	(o)		
Number of mug shelves		2 (std) / 4 (o)	2 (std) / 4 (o)	2 (std) / 4 (o)	2 (std) / 4 (o)	2 (std) / 4 (o)	2 (std) / 4 (o)	2 (std) / 4 (o)	2 (std) / 4 (o)	2 (std) / 4 (o)	2 (std) / 4 (o)	2 (std) / 4 (o)	2 (std) / 4 (o)	2 (std) / 4 (o)	2 (std) / 4 (o)	2 (std) / 4 (o)	2 (std) / 4 (o)	2 (std) / 4 (o)		
Adjustable mug shelves		Yes (peg type) / (o) (mesh type)																		
Mug shelves with soft touch rubber (only with peg type basket)		(o)	(o)	(o)	(o)	(o)	(o)	(o)	(o)	(o)	(o)	(o)	(o)	(o)	(o)	(o)	(o)	(o)		
Foldable racks on upper basket (only with peg type basket)		fixed (std) / 2 or 4 or 6 (o)																		
Foldable racks on lower basket		(o)	(o)	(o)	(o)	(o)	(o)	(o)	(o)	(o)	(o)	(o)	(o)	(o)	(o)	(o)	(o)	(o)		
Upper basket handle type [No / Wire / Plastic / Metal]		(o)	(o)	(o)	(o)	(o)	(o)	(o)	(o)	(o)	(o)	(o)	(o)	(o)	(o)	(o)	(o)	(o)		
Lower basket handle type [No / Wire / Plastic / Metal]		(o)	(o)	(o)	(o)	(o)	(o)	(o)	(o)	(o)	(o)	(o)	(o)	(o)	(o)	(o)	(o)	(o)		
Removable cutlery basket (Single piece)		(o)(12/13ps) / No(15ps)																		
Removable cutlery basket (Universal)		No(12/13ps) / (o)(15ps)																		
Removable cutlery basket (Modular) (2)		(o)	(o)	(o)	(o)	(o)	(o)	(o)	(o)	(o)	(o)	(o)	(o)	(o)	(o)	(o)	(o)	(o)		
Removable cutlery basket (Sliding) (3)		(o)(12/13ps) / No(15ps)																		
Multi functional kit (Extra mug shelves + higher rear part on lower basket)		(o)	(o)	(o)	(o)	(o)	(o)	(o)	(o)	(o)	(o)	(o)	(o)	(o)	(o)	(o)	(o)	(o)		
Bottle holder on lower basket		(o)	(o)	(o)	(o)	(o)	(o)	(o)	(o)	(o)	(o)	(o)	(o)	(o)	(o)	(o)	(o)	(o)		
Wine stem support & Spoon rack on upper basket (2)		(o)	(o)	(o)	(o)	(o)	(o)	(o)	(o)	(o)	(o)	(o)	(o)	(o)	(o)	(o)	(o)	(o)		
Wine glass holder on lower basket		(o) with 4 foldable racks																		
Top nozzle	fixed type with 2 baskets	(o) with Aquazone										(o)								
	rotating type	Default with 3rd basket																		
Aquastop external hose		(o)	(o)	(o)	(o)	(o)	(o)	(o)	(o)	(o)	(o)	(o)	(o)	(o)	(o)	(o)	(o)	(o)		
Antibacterial filter		(o)	(o)	(o)	(o)	(o)	(o)	(o)	(o)	(o)	(o)	(o)	(o)	(o)	(o)	(o)	(o)	(o)		
Anti-siphon system		(o)	(o)	(o)	(o)	(o)	(o)	(o)	(o)	(o)	(o)	(o)	(o)	(o)	(o)	(o)	(o)	(o)		
<b>Technical Data (4)</b>																				
Sound level (dB(A) re 1pW)	12 PS	57 / 54 / 49 / 47 / 45	57 / 54 / 49 / 47 / 45	57 / 54 / 49 / 47 / 45	57 / 54 / 49 / 47 / 45	57 / 54 / 49 / 47 / 45	57 / 54 / 49 / 47 / 45	57 / 54 / 49 / 47 / 45	57 / 54 / 49 / 47 / 45	57 / 54 / 49 / 47 / 45	57 / 54 / 49 / 47 / 45	57 / 54 / 49 / 47 / 45	57 / 54 / 49 / 47 / 45	57 / 54 / 49 / 47 / 45	57 / 54 / 49 / 47 / 45	57 / 54 / 49 / 47 / 45	57 / 54 / 49 / 47 / 45	46 / 44	49 / 47 / 44 / 42 / 41	
	13 PS	57 / 54 / 49 / 47 / 45	57 / 54 / 49 / 47 / 45	57 / 54 / 49 / 47 / 45	57 / 54 / 49 / 47 / 45	57 / 54 / 49 / 47 / 45	57 / 54 / 49 / 47 / 45	57 / 54 / 49 / 47 / 45	57 / 54 / 49 / 47 / 45	57 / 54 / 49 / 47 / 45	57 / 54 / 49 / 47 / 45	57 / 54 / 49 / 47 / 45	57 / 54 / 49 / 47 / 45	57 / 54 / 49 / 47 / 45	57 / 54 / 49 / 47 / 45	57 / 54 / 49 / 47 / 45	57 / 54 / 49 / 47 / 45	46 / 44	49 / 47 / 44 / 42 / 41	
	14 PS	-	-	-	-	-	-	-	-	-	-	-	-	-	-	-	-	-	-	-
	15 PS	49 / 47 / 45	49 / 47 / 45	49 / 47 / 45	49 / 47 / 45	49 / 47 / 45	49 / 47 / 45	49 / 47 / 45	49 / 47 / 45	49 / 47 / 45	49 / 47 / 45	49 / 47 / 45	49 / 47 / 45	49 / 47 / 45	49 / 47 / 45	49 / 47 / 45	49 / 47 / 45	49 / 47 / 45	44 / 42	49 / 47 / 44 / 42 / 39
Energy efficiency class		A++	A++	A++	A++	A++	A++	A++	A++	A++	A++	A++	A++	A++	A++	A++	A++	A++		
Energy efficiency index	12 PS	55,8	55,8	55,8	55,8	55,8	55,8	55,8	55,8	55,8	55,8	55,8	55,8	55,8	55,8	55,8	55,8	55,9	49,7	
	13 PS	55,6	55,6	55,6	55,6	55,6	55,6	55,6	55,6	55,6	55,6	55,6	55,6	55,6	55,6	55,6	55,6	55,7	49,9	
	14 PS	-	-	-	-	-	-	-	-	-	-	-	-	-	-	-	-	-	-	
	15 PS	55,8	55,8	55,8	55,8	55,8	55,8	55,8	55,8	55,8	55,8	55,8	55,8	55,8	55,8	55,8	55,8	55,9	49,9	
Cleaning efficiency class		A	A	A	A	A	A	A	A	A	A	A	A	A	A	A	A	A		
Cleaning efficiency index		1,13	1,13	1,13	1,13	1,13	1,13	1,13	1,13	1,13	1,13	1,13	1,13	1,13	1,13	1,13	1,13	1,13		
Drying efficiency class		A	A	A	A	A	A	A	A	A	A	A	A	A	A	A	A	A		
Drying efficiency index		1,09	1,09	1,09	1,09	1,09	1,09	1,09	1,09	1,09	1,09	1,09	1,09	1,09	1,09	1,09	1,09	1,09		
Standard programme water consumption (lt / cycle)	Default	12,0	12,0	12,0	12,0	12,0	12,0	12,0	12,0	12,0	12,0	12,0	12,0	12,0	12,0	12,0	12,0	12,0		
	with Aquazone	9,0	9,0	9,0	9,0	9,0	9,0	9,0	9,0	9,0	9,0	9,0	-	-	-	-	-	-		
Annual water consumption (lt / year)	Default	3360	3360	3360	3360	3360	3360	3360	3360	3360	3360	3360	2520	2520	2520	2520	2520	2520		
	with Aquazone	2520	2520	2520	2520	2520	2520	2520	2520	2520	2520	2520	-	-	-	-	-	-		

Y SERIES 60cm Models BUILT-IN DISHWASHERS		Y11	Y1A	Y12	Y1B	Y13	Y1C	Y14	Y1D	Y15	Y1E	Y1F	Y21	Y22	Y23	Y24	Y25	Y26
Duration of the standard programme (min)	Default	165	165	165	165	165	165	165	165	165	165	165	171	171	171	171	239	254
	with Aquazone	221	221	221	221	221	221	221	221	221	221	221	-	-	-	-	-	-
Standard programme energy consumption (kWh / cycle)	12 PS	0,900	0,900	0,900	0,900	0,900	0,900	0,900	0,900	0,900	0,900	0,900	0,900	0,900	0,900	0,901	0,800	0,800
	13 PS	0,910	0,910	0,910	0,910	0,910	0,910	0,910	0,910	0,910	0,910	0,910	0,910	0,910	0,910	0,912	0,815	0,815
	14 PS	-	-	-	-	-	-	-	-	-	-	-	-	-	-	-	-	-
	15 PS	0,942	0,942	0,942	0,942	0,942	0,942	0,942	0,942	0,942	0,942	0,942	0,942	0,942	0,942	0,943	0,840	0,840
Annual energy consumption (kWh / year)	12 PS	258	258	258	258	258	258	258	258	258	258	258	258	258	258	230	230	230
	13 PS	261	261	261	261	261	261	261	261	261	261	261	261	261	261	234	234	234
	14 PS	-	-	-	-	-	-	-	-	-	-	-	-	-	-	-	-	-
	15 PS	270	270	270	270	270	270	270	270	270	270	270	270	270	270	241	241	241
Off mode power consumption (W)		0,50	0,50	0,50	0,50	0,50	0,50	0,50	0,50	0,50	0,50	0,50	0,50	0,50	0,50	0,50	0,50	0,50
Left-on mode power consumption (W)		1,00	1,00	1,00	1,00	1,00	1,00	1,00	1,00	1,00	1,00	1,00	1,00	1,00	1,00	1,00	1,00	1,00
Network standby mode power consumption (W)		N/A	N/A	N/A	N/A	N/A	N/A	N/A	N/A	N/A	N/A	N/A	N/A	N/A	N/A	N/A	N/A	N/A
Duration of left-on mode (min)		N/A	N/A	N/A	N/A	N/A	N/A	N/A	N/A	N/A	N/A	N/A	N/A	N/A	N/A	N/A	N/A	N/A
Power rating (W) / Heating element (W)		1900 / 1800	1900 / 1800	1900 / 1800	1900 / 1800	1900 / 1800	1900 / 1800	1900 / 1800	1900 / 1800	1900 / 1800	1900 / 1800	1900 / 1800	1900 / 1800	1900 / 1800	1900 / 1800	1900 / 1800	1900 / 1800	1900 / 1800
Plug Type		EU / UK / Swiss / Italy / Israel / AU/NZ / China / Argentina / S.Africa																
Power cord length (cm)		165	165	165	165	165	165	165	165	165	165	165	165	165	165	165	165	165
Water inlet hose length (cm)	Default	147	147	147	147	147	147	147	147	147	147	147	147	147	147	147	147	147
	with Aquastop ext. hose	170	170	170	170	170	170	170	170	170	170	170	170	170	170	170	170	170
Water outlet hose length (cm)		200	200	200	200	200	200	200	200	200	200	200	200	200	200	200	200	200
Voltage (V) / Frequency (Hz) / Fuse Rating (A)		220-240 / 50 / 10																
Water pressure range (bar)		0,3 - 10																
Dimensions																		
Height (cm)	Freestanding	85,0	85,0	85,0	85,0	85,0	85,0	85,0	85,0	85,0	85,0	85,0	85,0	85,0	85,0	85,0	85,0	85,0
	Semi-Integrated	82,0	82,0	82,0	82,0	82,0	82,0	82,0	82,0	82,0	82,0	82,0	82,0	82,0	82,0	82,0	82,0	82,0
	Fully Integrated	-	-	-	-	-	-	-	-	-	-	-	-	-	-	-	-	-
Width (cm)		59,8	59,8	59,8	59,8	59,8	59,8	59,8	59,8	59,8	59,8	59,8	59,8	59,8	59,8	59,8	59,8	59,8
Depth (cm)	Freestanding	59,8	59,8	59,8	59,8	59,8	59,8	59,8	59,8	59,8	59,8	59,8	59,8	59,8	59,8	59,8	59,8	59,8
	Semi-Integrated	57,0	57,0	57,0	57,0	57,0	57,0	57,0	57,0	57,0	57,0	57,0	57,0	57,0	57,0	57,0	57,0	57,0
	Fully Integrated	-	-	-	-	-	-	-	-	-	-	-	-	-	-	-	-	-
Height adjustment (+cm)	Freestanding	2	2	2	2	2	2	2	2	2	2	2	2	2	2	2	2	2
	Semi-Integrated	5	5	5	5	5	5	5	5	5	5	5	5	5	5	5	5	5
	Fully Integrated	-	-	-	-	-	-	-	-	-	-	-	-	-	-	-	-	-
Adjustable Plinth for undertable usage (mm) Undertable		(o) (80 or/and 130)																
Possible adjustment of the plinth Undertable (horizontal / vertical) (mm / mm)		0-100 / 0-50																
Height without worktop (cm) Undertable		82,0	82,0	82,0	82,0	82,0	82,0	82,0	82,0	82,0	82,0	82,0	82,0	82,0	82,0	82,0	82,0	82,0
Decorative panel height (max) (cm) Semi-Integrated		59,7	59,7	59,7	59,7	59,7	59,7	59,7	59,7	59,7	59,7	59,7	59,7	59,7	59,7	59,7	59,7	59,7
Plinth height (min) (cm) Semi-Integrated		8	8	8	8	8	8	8	8	8	8	8	8	8	8	8	8	8
Plinth depth (cm) Semi-Integrated		3-8	3-8	3-8	3-8	3-8	3-8	3-8	3-8	3-8	3-8	3-8	3-8	3-8	3-8	3-8	3-8	3-8
Packed dimensions (Width x Depth x Height) (cm)	Freestanding	64.4 x 66.1 x 88.1																
	Semi-Integrated	64.4 x 66.1 x 85.1																
	Fully Integrated	-	-	-	-	-	-	-	-	-	-	-	-	-	-	-	-	-
Stacking quantity (pcs)	Freestanding	6 (2 baskets) / 4 (3rd basket)																
	Semi-Integrated	6	6	6	6	6	6	6	6	6	6	6	6	6	6	6	6	6
	Fully Integrated	-	-	-	-	-	-	-	-	-	-	-	-	-	-	-	-	-
Gross/Net weight (kg)(5)	Freestanding	49 /46 - 56 /53																
	Semi-Integrated	43 /41	43 /41	43 /41	43 /41	43 /41	43 /41	43 /41	43 /41	43 /41	43 /41	43 /41	43 /41	43 /41	43 /41	43 /41	43 /41	43 /41
	Fully Integrated	-	-	-	-	-	-	-	-	-	-	-	-	-	-	-	-	-
Container loading (40"HC/ 40" / 20")		162 /108 /54																

Notes

(o) : Optional

(\*\*): Auto programme can be chosen instead of Intensive programme (with turbidity sensor)

(1): Turbo Fan feature & 3rd basket (& Aquazone for w/o diverter models) are default for 15 PS models.

For w/o diverter models; 3rd basket can be selected only with Aquazone.

Touch control is available with negative LCD display (Aron and Daphne only)"

(2) : Modular cutlery basket for 12/13 PS must be selected with wine stem support & spoon rack. Also wine stem support & spoon rack can be selected only for mesh type upper basket option.

(3) : Can be selected for lower basket with fixed type or with 4 foldable wire.

(4) : Based on the tests performed with Eco programme in accordance with European Household Dishwasher Performance Standards

(5) : Gross/Net Weights are shown as reference in the table. It should be calculated based on the final product features created from this general spect table.

T1-2 SERIES 60cm Models BUILT-IN DISHWASHERS		T11	T12	T13	T21	T24	T25	T26
<b>General Characteristics</b>								
<b>Number of place settings (PS)(1)</b>	12 PS (2 baskets)	Default	Default	Default	Default	Default	-	Default
	13 PS (2 baskets)	(o)	(o)	(o)	(o)	(o)	-	(o)
	13 PS (2 baskets + 3rd rack)	(o) with Aquazone	(o) with Aquazone	(o) with Aquazone	(o)	(o)	-	(o)
	14 PS (2 baskets + 3rd rack)	-	-	-	-	-	Default	-
	15 PS (2 baskets + 3rd rack)	(o) with Aquazone and Turbo fan	(o) with Aquazone and Turbo fan	(o) with Aquazone and Turbo fan	(o) with Turbo fan	(o)	-	(o)
<b>Number of programmes</b>	3	4	6	8+	8+	8+	8+	8+
<b>Temperatures (°C)</b>	50-65	40-50-65	40-50-65	Auto-30-40-50-60-65-70	Auto-30-40-50-60-65-70	Auto-30-40-50-60-65-70	Auto-30-40-50-60-65-70	Auto-30-40-50-60-65-70
<b>Control type</b>	Default	Button Control	Button Control	Button Control	Button Control	Button Control	Button Control	Button Control
	Option	-	-	-	-	-	-	-
<b>Hidden heating element</b>		Yes	Yes	Yes	Yes	Yes	Yes	Yes
<b>Filter type</b>	Metal	Default	Default	Default	Default	Default	Default	Default
	Plastic	(o)	(o)	(o)	(o)	-	-	-
<b>Tub material</b>		Stainless Steel	Stainless Steel	Stainless Steel	Stainless Steel	Stainless Steel	Stainless Steel	Stainless Steel
<b>Turbidity sensor (Smart Wash)</b>		(o)	(o)	(o)	Yes	Yes	Yes	Yes
<b>Drying system</b>	Mini Active	Default	Default	Default	Default	-	-	-
	Super Active	(o)	(o)	(o)	(o)	-	-	-
	Turbo	(o)	(o)	(o)	(o)	Default	Default	Default
<b>Electrical Diverter system</b>		-	-	-	Yes	Yes	Yes	Yes
<b>Overflow &amp; leakage protection</b>		Yes	Yes	Yes	Yes	Yes	Yes	Yes
<b>Heater protection</b>		Yes	Yes	Yes	Yes	Yes	Yes	Yes
<b>Circulation pump</b>	Asynchronous	Yes	Yes	Yes	Yes	-	-	-
	BLDC	-	-	-	-	Yes	Yes	Yes
<b>Auto Door</b>		-	-	-	-	Yes	Yes	-
<b>Water Box</b>		-	-	-	-	-	Yes	-
<b>Triple &amp; Direct Wash</b>		-	-	-	-	(o)	(o)	-
<b>Aquazone</b>		(o)	(o)	(o)	-	-	-	-
<b>Wi-fi</b>		-	-	-	-	-	-	-
<b>New Indoor Design</b>		(o)	(o)	(o)	(o)	(o)	(o)	(o)
<b>Sliding Door</b>		-	-	-	-	-	-	-
<b>Ion Tech</b>		(o)	(o)	(o)	(o)	(o)	(o)	(o)
<b>Uvon Tech</b>		-	-	-	-	-	-	-
<b>InfoLED</b>	1,0	-	-	-	-	-	-	-
	2,0 (Floor Indicator)	-	-	-	-	-	-	-
<b>Interior light</b>	one spot	(o)	(o)	(o)	(o)	(o)	(o)	(o)
	four spot	(o)	(o)	(o)	(o)	(o)	(o)	(o)
<b>Available Aesthetics</b>	Freestanding	Amaranth, Claros, Pagos, Spilos, Themis	Amaranth, Claros, Pagos, Spilos, Themis	Amaranth, Claros, Pagos, Spilos, Themis	Amaranth, Claros, Pagos, Spilos, Themis	Amaranth, Claros, Pagos, Spilos, Themis	Amaranth, Claros, Pagos, Spilos, Themis	Amaranth, Claros, Pagos, Spilos, Themis
	Semi-Integrated	Amaranth	Amaranth	Amaranth	Amaranth	Amaranth	Amaranth	Amaranth
	Fully Integrated	-	-	-	-	-	-	-
<b>Appliance Color Options</b>		Black, Dark Gray, Dark Inox, Dark Silver, Inox, White	Black, Dark Gray, Dark Inox, Dark Silver, Inox, White	Black, Dark Gray, Dark Inox, Dark Silver, Inox, White	Black, Dark Gray, Dark Inox, Dark Silver, Inox, White	Black, Dark Gray, Dark Inox, Dark Silver, Inox, White	Black, Dark Gray, Dark Inox, Dark Silver, Inox, White	Black, Dark Gray, Dark Inox, Dark Silver, Inox, White
<b>Programmes</b>								
<b>Prewash</b>		-	-	Yes	Yes	-	-	-
<b>Mini 14' (Jet Wash)</b>		-	-	-	-	Yes	Yes	Yes
<b>Quick 30' 40°C</b>		-	Yes	Yes	Yes	Yes	Yes	Yes
<b>Eco (Standard Programme)</b>		Yes	Yes	Yes	Yes	Yes	Yes	Yes
<b>Super 50' 65°C (Quick Clean)</b>		Yes	Yes	Yes	Yes	Yes	Yes	Yes
<b>Super 55' 60°C</b>		-	-	-	-	-	-	-
<b>Delicate 40°C</b>		-	-	Yes	-	-	-	-
<b>Normal 55°C / Flexi Wash 55°C</b>		-	-	-	-	-	-	-
<b>Daily 60°C / Hybrid Wash 60°C</b>		-	-	-	Yes	-	-	-
<b>Dual Pro Wash 60°C</b>		-	-	-	-	Yes	Yes	Yes
<b>Hygiene 60°C</b>		-	-	-	-	-	-	-
<b>Hygiene 70°C</b>		-	-	-	-	Yes	Yes	Yes
<b>Intensive 65°C</b>		Yes	Yes	Yes	-	-	-	-
<b>Auto**</b>		(o)	(o)	(o)	-	-	-	-
<b>Auto Delicate 30°C - 50°C</b>		-	-	-	Yes	Yes	Yes	Yes
<b>Auto Normal 50°C - 60°C / Auto Flex 50°C - 60°C</b>		-	-	-	Yes	-	-	-
<b>Auto Intensive 60°C - 70°C</b>		-	-	-	Yes	Yes (50°C-70°C)	Yes (50°C-70°C)	Yes (50°C-70°C)

T1-2 SERIES 60cm Models BUILT-IN DISHWASHERS		T11	T12	T13	T21	T24	T25	T26
<b>User Interface</b>								
<b>Start/Pause button</b>		Yes	Yes	Yes	Yes	Yes	Yes	Yes
<b>DISPLAY TYPE (delay start, remaining time)</b>		-	LED	LED	LED	LED	LED	LED
<b>Display Color</b>	Default	-	Red	Red	Red	Red	Red	Red
	Option	-	-	-	-	-	-	-
<b>Programme selection button</b>		Yes	Yes	Yes	Yes	Yes	Yes	Yes
<b>Delay timer option</b>	3hr,6hr,9hr	-	-	-	-	-	-	-
	1-2-3-...-19hr	-	-	-	-	-	-	-
	1-2-3-...-24hr	-	Yes	Yes	Yes	Yes	Yes	Yes
<b>Eco Wash - Half load option</b>	1 mode	Yes	Yes	Yes	-	-	-	-
	3 modes	-	-	-	Yes	Yes	Yes	Yes
<b>Tablet option</b>		-	-	Yes	Yes	Yes	Yes	Yes
<b>Extra Hygiene option</b>		-	-	Yes	Yes	-	-	-
<b>Extra Rinse option</b>		-	-	-	Yes	-	-	-
<b>Extra Drying option</b>		-	-	-	Yes	-	-	Yes
<b>Extra Silent option (Silent Wash)</b>		-	-	-	-	Yes	Yes	Yes
<b>Extra Fast option</b>		-	-	-	-	Yes	Yes	Yes
<b>Energy Save option</b>		-	-	-	-	Yes	Yes	-
<b>Rinse-aid indicator</b>		Yes	Yes	Yes	Yes	Yes	Yes	Yes
<b>Salt indicator</b>		Yes	Yes	Yes	Yes	Yes	Yes	Yes
<b>Washing cycle indicators</b>		Yes	Yes	Yes	Yes	Yes	Yes	Yes
<b>End of cycle indicator</b>		Yes	Yes	Yes	Yes	Yes	Yes	Yes
<b>Child Lock</b>		Yes	Yes	Yes	Yes	Yes	Yes	Yes
<b>Buzzer</b>		-	-	-	-	Yes	Yes	-
<b>Baskets &amp; Accessories</b>								
<b>3rd basket [EasyTray, EcoTray or Comfort Tray]</b>	12 PS	-	-	-	-	-	-	-
	13 PS	(o)	(o)	(o)	(o)	(o)	-	(o)
	14 PS	-	-	-	-	-	Yes	-
	15 PS	Yes	Yes	Yes	Yes	Yes	-	Yes
<b>Upper basket type [mesh type / peg type]</b>		(o)	(o)	(o)	(o)	(o)	Peg	(o)
<b>Adjustable upper basket [empty/ loaded 2 level / loaded 3 level*]</b>		(o)	(o)	(o)	(o)	(o)	(o)	(o)
<b>Number of mug shelves</b>		2 (std) / 4 (o)	2 (std) / 4 (o)	2 (std) / 4 (o)	2 (std) / 4 (o)	2 (std) / 4 (o)	4	2 (std) / 4 (o)
<b>Adjustable mug shelves</b>		Yes (peg type) / (o) (mesh type)	Yes (peg type) / (o) (mesh type)	Yes (peg type) / (o) (mesh type)	Yes (peg type) / (o) (mesh type)	Yes (peg type) / (o) (mesh type)	Yes	Yes (peg type) / (o) (mesh type)
<b>Mug shelves with soft touch rubber (only with peg type basket)</b>		(o)	(o)	(o)	(o)	(o)	(o)	(o)
<b>Foldable racks on upper basket (only with peg type basket)</b>		fixed (std) / 2 or 4 or 6 (o)	fixed (std) / 2 or 4 or 6 (o)	fixed (std) / 2 or 4 or 6 (o)	fixed (std) / 2 or 4 or 6 (o)	fixed (std) / 2 or 4 or 6 (o)	4 or 6 (o)	fixed (std) / 2 or 4 or 6 (o)
<b>Foldable racks on lower basket</b>		(o)	(o)	(o)	(o)	(o)	Yes	(o)
<b>Upper basket handle type [No / Wire / Plastic / Metal]</b>		(o)	(o)	(o)	(o)	(o)	-	(o)
<b>Lower basket handle type [No / Wire / Plastic / Metal]</b>		(o)	(o)	(o)	(o)	(o)	(o)	(o)
<b>Removable cutlery basket (Single piece)</b>		(o)(12/13ps) / No(15ps)	(o)(12/13ps) / No(15ps)	(o)(12/13ps) / No(15ps)	(o)(12/13ps) / No(15ps)	(o)(12/13ps) / No(15ps)	-	(o)(12/13ps) / No(15ps)
<b>Removable cutlery basket (Universal)</b>		No(12/13ps) / (o)(15ps)	No(12/13ps) / (o)(15ps)	No(12/13ps) / (o)(15ps)	No(12/13ps) / (o)(15ps)	No(12/13ps) / (o)(15ps)	(o)	No(12/13ps) / (o)(15ps)
<b>Removable cutlery basket (Modular) (2)</b>		(o)	(o)	(o)	(o)	(o)	(o)	(o)
<b>Removable cutlery basket (Sliding) (3)</b>		(o)(12/13ps) / No(15ps)	(o)(12/13ps) / No(15ps)	(o)(12/13ps) / No(15ps)	(o)(12/13ps) / No(15ps)	(o)(12/13ps) / No(15ps)	-	(o)(12/13ps) / No(15ps)
<b>Multi functional kit (Extra mug shelves + higher rear part on lower basket)</b>		(o)	(o)	(o)	(o)	(o)	(o)	(o)
<b>Bottle holder on lower basket</b>		(o)	(o)	(o)	(o)	(o)	(o)	(o)
<b>Wine stem support &amp; Spoon rack on upper basket (2)</b>		(o)	(o)	(o)	(o)	(o)	-	(o)
<b>Wine glass holder on lower basket</b>		(o) with 4 foldable racks	(o) with 4 foldable racks	(o) with 4 foldable racks	(o) with 4 foldable racks	(o) with 4 foldable racks	(o) with 4 foldable racks	(o) with 4 foldable racks
<b>Top nozzle</b>	fixed type with 2 baskets	(o) with Aquazone	(o) with Aquazone	(o) with Aquazone	(o)	(o)	-	(o)
	rotating type	Default with 3rd basket	Default with 3rd basket	Default with 3rd basket	Default with 3rd basket	Default with 3rd basket	Default	Default with 3rd basket
<b>Aquastop external hose</b>		(o)	(o)	(o)	(o)	(o)	(o)	(o)
<b>Antibacterial filter</b>		(o)	(o)	(o)	(o)	(o)	(o)	(o)
<b>Anti-siphon system</b>		(o)	(o)	(o)	(o)	(o)	(o)	(o)
<b>Technical Data (4)</b>								
<b>Sound level (dB(A) re 1 pW)</b>	12 PS	57 / 54 / 52 / 49 / 47 / 45	57 / 54 / 52 / 49 / 47 / 45	57 / 54 / 52 / 49 / 47 / 45	57 / 54 / 52 / 49 / 47 / 45	46 / 44	-	49 / 47 / 45 / 44 / 42 / 41
	13 PS	57 / 54 / 52 / 49 / 47 / 45	57 / 54 / 52 / 49 / 47 / 45	57 / 54 / 52 / 49 / 47 / 45	57 / 54 / 52 / 49 / 47 / 45	46 / 44	-	49 / 47 / 45 / 44 / 42 / 41
	14 PS	-	-	-	-	-	44	-
	15 PS	49 / 47 / 45	49 / 47 / 45	49 / 47 / 45	49 / 47 / 45	44 / 42	-	49 / 47 / 45 / 44 / 42 / 41 / 39
<b>Energy efficiency class</b>		A++	A++	A++	A++	A+++	A+++ -20%	A+++
<b>Energy efficiency index</b>	12 PS	55,8	55,8	55,8	55,8	49,8	-	49,7
	13 PS	55,6	55,6	55,6	55,6	49,9	-	49,9
	14 PS	-	-	-	-	-	39,7	-
	15 PS	55,8	55,8	55,8	55,3	49,5	-	49,9
<b>Cleaning efficiency class</b>		A	A	A	A	A	A	A
<b>Cleaning efficiency index</b>		1,13	1,13	1,13	1,13	1,13	1,13	1,13
<b>Drying efficiency class</b>		A	A	A	A	A	A	A



T1-2 SERIES 60cm Models BUILT-IN DISHWASHERS		T11	T12	T13	T21	T24	T25	T26
<b>Technical Data (4)</b>								
<b>Drying efficiency index</b>		1,09	1,09	1,09	1,09	1,09	1,09	1,09
<b>Standard programme water consumption (lt / cycle)</b>	Default	12,0	12,0	12,0	9,0	9,0	9,0	9,0
	with Aquazone	9,0	9,0	9,0	-	-	-	-
<b>Annual water consumption (lt / year)</b>	Default	3360	3360	3360	2520	2520	2520	2520
	with Aquazone	2520	2520	2520	-	-	-	-
<b>Duration of the standard programme (min)</b>	Default	165	165	165	171	239	207	254
	with Aquazone	221	221	221	-	-	-	-
<b>Standard programme energy consumption (kWh / cycle)</b>	12 PS	0,900	0,900	0,900	0,900	0,806	-	0,800
	13 PS	0,910	0,910	0,910	0,910	0,820	-	0,815
	14 PS	-	-	-	-	-	0,659	-
	15 PS	0,942	0,942	0,942	0,932	0,838	-	0,840
<b>Annual energy consumption (kWh / year)</b>	12 PS	258	258	258	258	230	-	230
	13 PS	261	261	261	261	234	-	234
	14 PS	-	-	-	-	-	189	-
	15 PS	270	270	270	267	239	-	241
<b>Off mode power consumption (W)</b>		0,50	0,50	0,50	0,50	0,10	0,10	0,50
<b>Left-on mode power consumption (W)</b>		1,00	1,00	1,00	1,00	1,00	1,00	1,00
<b>Network standby mode power consumption (W)</b>		N/A	N/A	N/A	N/A	N/A	N/A	N/A
<b>Duration of left-on mode (min)</b>		N/A	N/A	N/A	N/A	N/A	N/A	N/A
<b>Power rating (W) / Heating element (W)</b>		1900 / 1800	1900 / 1800	1900 / 1800	1900 / 1800	1900 / 1800	1900 / 1800	1900 / 1800
<b>Plug Type</b>		EU / UK / Swiss / Italy / Israel / AU/NZ / China / Argentina / S.Africa	EU / UK / Swiss / Italy / Israel / AU/NZ / China / Argentina / S.Africa	EU / UK / Swiss / Italy / Israel / AU/NZ / China / Argentina / S.Africa	EU / UK / Swiss / Italy / Israel / AU/NZ / China / Argentina / S.Africa	EU / UK / Swiss / Italy / Israel / AU/NZ / China / Argentina / S.Africa	EU / UK / Swiss / Italy / Israel / AU/NZ / China / Argentina / S.Africa	EU / UK / Swiss / Italy / Israel / AU/NZ / China / Argentina / S.Africa
<b>Power cord length (cm)</b>		165	165	165	165	165	165	165
<b>Water inlet hose length (cm)</b>	Default	147	147	147	147	147	147	147
	with Aquastop ext. hose	170	170	170	170	170	170	170
<b>Water outlet hose length (cm)</b>		200	200	200	200	200	200	200
<b>Voltage (V) / Frequency (Hz) / Fuse Rating (A)</b>		220-240 / 50 / 10	220-240 / 50 / 10	220-240 / 50 / 10	220-240 / 50 / 10	220-240 / 50 / 10	220-240 / 50 / 10	220-240 / 50 / 10
<b>Water pressure range (bar)</b>		0,3 - 10	0,3 - 10	0,3 - 10	0,3 - 10	0,3 - 10	0,3 - 10	0,3 - 10
<b>Dimensions</b>								
<b>Height (cm)</b>	Freestanding	85,0	85,0	85,0	85,0	85,0	85,0	85,0
	Semi-Integrated	82,0	82,0	82,0	82,0	82,0	82,0	82,0
	Fully Integrated	-	-	-	-	-	-	-
<b>Width (cm)</b>		59,8	59,8	59,8	59,8	59,8	59,8	59,8
<b>Depth (cm)</b>	Freestanding	59,8	59,8	59,8	59,8	59,8	59,8	59,8
	Semi-Integrated	57,0	57,0	57,0	57,0	57,0	57,0	57,0
	Fully Integrated	-	-	-	-	-	-	-
<b>Height adjustment (+cm)</b>	Freestanding	2	2	2	2	2	2	2
	Semi-Integrated	5	5	5	5	5	5	5
	Fully Integrated	-	-	-	-	-	-	-
<b>Adjustable Plinth for undertable usage (mm) Undertable</b>		(o) (80 or/and 130)	(o) (80 or/and 130)	(o) (80 or/and 130)	(o) (80 or/and 130)	(o) (80 or/and 130)	(o) (80 or/and 130)	(o) (80 or/and 130)
<b>Possible adjustment of the plinth Undertable (horizontal / vertical) (mm / mm)</b>		0-100 / 0-50	0-100 / 0-50	0-100 / 0-50	0-100 / 0-50	0-100 / 0-50	0-100 / 0-50	0-100 / 0-50
<b>Height without worktop (cm) Undertable</b>		82,0	82,0	82,0	82,0	82,0	82,0	82,0
<b>Decorative panel height (max) (cm) Semi-Integrated</b>		59,7	59,7	59,7	59,7	59,7	59,7	59,7
<b>Plinth height (min) (cm) Semi-Integrated</b>		8	8	8	8	8	8	8
<b>Plinth depth (cm) Semi-Integrated</b>		3 - 8	3 - 8	3 - 8	3 - 8	3 - 8	3 - 8	3 - 8
<b>Packed dimensions (Width x Depth x Height) (cm)</b>	Freestanding	64.4 x 66.1 x 88.1	64.4 x 66.1 x 88.1	64.4 x 66.1 x 88.1	64.4 x 66.1 x 88.1	64.4 x 66.1 x 88.1	64.4 x 66.1 x 88.1	64.4 x 66.1 x 88.1
	Semi-Integrated	64.4 x 66.1 x 85.1	64.4 x 66.1 x 85.1	64.4 x 66.1 x 85.1	64.4 x 66.1 x 85.1	64.4 x 66.1 x 85.1	64.4 x 66.1 x 85.1	64.4 x 66.1 x 85.1
	Fully Integrated	-	-	-	-	-	-	-
<b>Stacking quantity (pcs)</b>	Freestanding	6 (2 baskets) / 4 (3rd basket)	6 (2 baskets) / 4 (3rd basket)	6 (2 baskets) / 4 (3rd basket)	6 (2 baskets) / 4 (3rd basket)	6 (2 baskets) / 4 (3rd basket)	4	6 (2 baskets) / 4 (3rd basket)
	Semi-Integrated	6	6	6	6	6	6	6
	Fully Integrated	-	-	-	-	-	-	-
<b>Gross/Net weight (kg)(5)</b>	Freestanding	49 /46 - 56 /53	49 /46 - 56 /53	49 /46 - 56 /53	49 /46 - 56 /53	49 /46 - 56 /53	56 /53	49 /46 - 56 /53
	Semi-Integrated	43 /41	43 /41	43 /41	43 /41	43 /41	43 /41	43 /41
	Fully Integrated	-	-	-	-	-	-	-
<b>Container loading (40"HC/ 40" / 20")</b>		162 /108 /54	162 /108 /54	162 /108 /54	162 /108 /54	162 /108 /54	162 /108 /54	162 /108 /54

Notes

(o) : Optional

(\*\*) : Auto programme can be chosen instead of Intensive programme (with turbidity sensor)

(1) : Turbo Fan feature & 3rd basket (& Aquazone for w/o diverter models) are default for 15 PS models.

For w/o diverter models; 3rd basket can be selected only with Aquazone.

Touch control is available with negative LCD display (Aron and Daphne only)"

(2) : Modular cutlery basket for 12/13 PS must be selected with wine stem support & spoon rack. Also wine stem support & spoon rack can be selected only for mesh type upper basket option.

(3) : Can be selected for lower basket with fixed type or with 4 foldable wire.

(4) : Based on the tests performed with Eco programme in accordance with European Household Dishwasher Performance Standards

(5) : Gross/Net Weights are shown as reference in the table. It should be calculated based on the final product features created from this general spec table.

T3 SERIES 60cm Models BUILT-IN DISHWASHERS		T31	T32	T34	T35	T36
<b>General Characteristics</b>						
<b>Number of place settings (PS)(1)</b>	12 PS (2 baskets)	Default	Default	Default	-	Default
	13 PS (2 baskets)	(o)	(o)	(o)	-	(o)
	13 PS (2 baskets + 3rd rack)	(o)	(o)	(o)	-	(o)
	14 PS (2 baskets + 3rd rack)	-	-	-	Default	-
	15 PS (2 baskets + 3rd rack)	(o) with Turbo fan	(o) with Turbo fan	(o)	-	(o)
<b>Number of programmes</b>	6+	8+	8+	8+	8+	
<b>Temperatures (°C)</b>	Auto-30-40-50-60-65-70	Auto-30-40-50-60-65-70	Auto-30-40-50-60-65-70	Auto-30-40-50-60-65-70	Auto-30-40-50-60-65-70	
<b>Control type</b>	Default	Button Control	Button Control	Button Control	Button Control	Button Control
	Option	-	-	-	-	-
<b>Hidden heating element</b>	Yes	Yes	Yes	Yes	Yes	
<b>Filter type</b>	Metal	Default	Default	Default	Default	Default
	Plastic	(o)	(o)	-	-	-
<b>Tube material</b>	Stainless Steel	Stainless Steel	Stainless Steel	Stainless Steel	Stainless Steel	
<b>Turbidity sensor (Smart Wash)</b>	Yes	Yes	Yes	Yes	Yes	
<b>Drying system</b>	Mini Active	Default	Default	-	-	-
	Super Active	(o)	(o)	-	-	-
	Turbo	(o)	(o)	Default	Default	Default
<b>Electrical Diverter system</b>	Yes	Yes	Yes	Yes	Yes	
<b>Overflow &amp; leakage protection</b>	Yes	Yes	Yes	Yes	Yes	
<b>Heater protection</b>	Yes	Yes	Yes	Yes	Yes	
<b>Circulation pump</b>	Asynchronous	Yes	Yes	-	-	-
	BLDC	-	-	Yes	Yes	Yes
<b>Auto Door</b>	-	-	Yes	Yes	-	
<b>Water Box</b>	-	-	-	Yes	-	
<b>Triple &amp; Direct Wash</b>	(o)	(o)	(o)	(o)	-	
<b>Aquazone</b>	-	-	-	-	-	
<b>Wi-fi</b>	-	-	-	-	-	
<b>New Indoor Design</b>	(o)	(o)	(o)	(o)	(o)	
<b>Sliding Door</b>	-	-	-	-	-	
<b>Ion Tech</b>	(o)	(o)	(o)	(o)	(o)	
<b>Uvon Tech</b>	-	-	-	-	-	
<b>Interior light</b>	one spot	(o)	(o)	(o)	(o)	(o)
	four spot	(o)	(o)	(o)	(o)	(o)
<b>Available Aesthetics</b>	Freestanding	Ares, Gizem, Hemera, Patara	Ares, Gizem, Hemera, Patara	Ares, Gizem, Hemera, Patara	Ares, Gizem, Hemera, Patara	Ares, Gizem, Hemera, Patara
	Semi-Integrated	Ares, Patara	Ares, Patara	Ares, Patara	Ares, Patara	Ares, Patara
	Fully Integrated	-	-	-	-	-
<b>Appliance Color Options</b>	Black, Dark Gray, Dark Inox, Dark Silver, Inox, White	Black, Dark Gray, Dark Inox, Dark Silver, Inox, White	Black, Dark Gray, Dark Inox, Dark Silver, Inox, White	Black, Dark Gray, Dark Inox, Dark Silver, Inox, White	Black, Dark Gray, Dark Inox, Dark Silver, Inox, White	
<b>Programmes</b>						
<b>Prewash</b>	Yes	Yes	-	-	-	
<b>Mini 14' (Jet Wash)</b>	Yes	Yes	Yes	Yes	Yes	
<b>Quick 30' 40°C</b>	Yes	Yes	Yes	Yes	Yes	
<b>Eco (Standard Programme)</b>	Yes	Yes	Yes	Yes	Yes	
<b>Super 50' 65°C (Quick Clean)</b>	Yes	Yes	Yes	Yes	Yes	
<b>Dual Pro Wash 60°C</b>	-	-	Yes	Yes	Yes	
<b>Hygiene 60°C</b>	-	-	-	-	-	
<b>Hygiene 70°C</b>	-	-	Yes	Yes	Yes	
<b>Auto Delicate 30°C - 50°C</b>	-	Yes	Yes	Yes	Yes	
<b>Auto Normal 50°C - 60°C / Auto Flex 50°C - 60°C</b>	-	Yes	-	-	-	
<b>Auto Intensive 60°C - 70°C</b>	Yes	Yes	Yes (50°C - 70°C)	Yes (50°C - 70°C)	Yes (50°C - 70°C)	
<b>User Interface</b>						
<b>Start/Pause button</b>	Yes	Yes	Yes	Yes	Yes	
<b>DISPLAY TYPE (delay start, remaining time)</b>	Icon LED	Icon LED	Icon LED	Icon LED	Icon LED	
<b>Display Color</b>	Default	Amber	Amber	Amber	Amber	
	Option	White	White	White	White	
<b>Prewash button</b>	-	-	-	-	-	
<b>Programme selection button</b>	Yes	Yes	Yes	Yes	Yes	
<b>Delay timer option</b>	3hr,6hr,9hr	-	-	-	-	
	1-2-3-...-19hr	-	-	-	-	
	1-2-3-...-24hr	Yes	Yes	Yes	Yes	
<b>Eco Wash - Half load option</b>	1 mode	-	-	-	-	
	3 modes	Yes	Yes	Yes	Yes	
<b>Tablet option</b>	Yes	Yes	Yes	Yes	Yes	
<b>Extra Hygiene option</b>	Yes	Yes	-	-	-	
<b>Extra Rinse option</b>	-	-	-	-	-	
<b>Extra Drying option</b>	Yes	Yes	-	-	Yes	
<b>Extra Silent option (Silent Wash)</b>	-	-	Yes	Yes	Yes	
<b>Extra Fast option</b>	-	-	Yes	Yes	Yes	
<b>Energy Save option</b>	-	-	Yes	Yes	-	

T3 SERIES 60cm Models BUILT-IN DISHWASHERS		T31	T32	T34	T35	T36
<b>User Interface</b>						
Rinse-aid indicator		Yes	Yes	Yes	Yes	Yes
Salt indicator		Yes	Yes	Yes	Yes	Yes
Washing cycle indicators		Yes	Yes	Yes	Yes	Yes
End of cycle indicator		Yes	Yes	Yes	Yes	Yes
Child Lock		Yes	Yes	Yes	Yes	Yes
Buzzer		Yes	Yes	Yes	Yes	Yes
<b>Baskets &amp; Accessories</b>						
3rd basket [EasyTray, EcoTray or Comfort Tray]	12 PS	-	-	-	-	-
	13 PS	(o)	(o)	(o)	-	(o)
	14 PS	-	-	-	Yes	-
	15 PS	Yes	Yes	Yes	-	Yes
Upper basket type [mesh type / peg type]		(o)	(o)	(o)	Peg	(o)
Adjustable upper basket [empty/ loaded 2 level / loaded 3 level*]		(o)	(o)	(o)	(o)	(o)
Number of mug shelves		2 (std) / 4 (o)	2 (std) / 4 (o)	2 (std) / 4 (o)	4	2 (std) / 4 (o)
Adjustable mug shelves		Yes (peg type) / (mesh type) (o)	Yes (peg type) / (mesh type) (o)	Yes (peg type) / (mesh type) (o)	Yes	Yes (peg type) / (mesh type) (o)
Mug shelves with soft touch rubber (only with peg type basket)		(o)	(o)	(o)	(o)	(o)
Foldable racks on upper basket (only with peg type basket)		fixed (std) / 2 or 4 or 6 (o)	fixed (std) / 2 or 4 or 6 (o)	fixed (std) / 2 or 4 or 6 (o)	4 or 6 (o)	fixed (std) / 2 or 4 or 6 (o)
Foldable racks on lower basket		(o)	(o)	(o)	Yes	(o)
Upper basket handle type [No / Wire / Plastic / Metal]		(o)	(o)	(o)	-	(o)
Lower basket handle type [No / Wire / Plastic / Metal]		(o)	(o)	(o)	(o)	(o)
Removable cutlery basket (Single piece)		(o)(12/13ps) / No(15ps)	(o)(12/13ps) / No(15ps)	(o)(12/13ps) / No(15ps)	-	(o)(12/13ps) / No(15ps)
Removable cutlery basket (Universal)		No(12/13ps) / (o)(15ps)	No(12/13ps) / (o)(15ps)	No(12/13ps) / (o)(15ps)	(o)	No(12/13ps) / (o)(15ps)
Removable cutlery basket (Modular) (2)		(o)	(o)	(o)	(o)	(o)
Removable cutlery basket (Sliding) (3)		(o)(12/13ps) / No(15ps)	(o)(12/13ps) / No(15ps)	(o)(12/13ps) / No(15ps)	-	(o)(12/13ps) / No(15ps)
Multi functional kit (Extra mug shelves + higher rear part on lower basket)		(o)	(o)	(o)	(o)	(o)
Bottle holder on lower basket		(o)	(o)	(o)	(o)	(o)
Wine stem support & Spoon rack on upper basket (2)		(o)	(o)	(o)	-	(o)
Wine glass holder on lower basket		(o) with 4 foldable racks	(o) with 4 foldable racks	(o) with 4 foldable racks	(o) with 4 foldable racks	(o) with 4 foldable racks
Top nozzle	fixed type with 2 baskets	(o)	(o)	(o)	-	(o)
	rotating type	Default with 3rd basket	Default with 3rd basket	Default with 3rd basket	Default	Default with 3rd basket
Aquastop external hose		(o)	(o)	(o)	(o)	(o)
Antibacterial filter		(o)	(o)	(o)	(o)	(o)
Anti-siphon system		(o)	(o)	(o)	(o)	(o)
<b>Technical Data (4)</b>						
Sound level (dB(A) re 1pW)	12 PS	57 / 54 / 52 / 49 / 47 / 45	57 / 54 / 52 / 49 / 47 / 45	46 / 44	-	49 / 47 / 45 / 44 / 42 / 41
	13 PS	57 / 54 / 52 / 49 / 47 / 45	57 / 54 / 52 / 49 / 47 / 45	46 / 44	-	49 / 47 / 45 / 44 / 42 / 41
	14 PS	-	-	-	44	-
	15 PS	49 / 47 / 45	49 / 47 / 45	44 / 42	-	49 / 47 / 45 / 44 / 42 / 41 / 39
Energy efficiency class		A++	A++	A+++	A+++ -20%	A+++
Energy efficiency index	12 PS	55,8	55,8	49,8	-	49,7
	13 PS	55,6	55,6	49,9	-	49,9
	14 PS	-	-	-	39,7	-
	15 PS	55,3	55,3	49,5	-	49,9
Cleaning efficiency class		A	A	A	A	A
Cleaning efficiency index		1,13	1,13	1,13	1,13	1,13
Drying efficiency class		A	A	A	A	A
Drying efficiency index		1,09	1,09	1,09	1,09	1,09
Standard programme water consumption (lt / cycle)	Default	9,0	9,0	9,0	9,0	9,0
	with Aquazone	-	-	-	-	-
Annual water consumption (lt / year)	Default	2520	2520	2520	2520	2520
	with Aquazone	-	-	-	-	-
Duration of the standard programme (min)	Default	171	171	239	207	270
	with Aquazone	-	-	-	-	-
Standard programme energy consumption (kWh / cycle)	12 PS	0,900	0,900	0,806	-	0,800
	13 PS	0,910	0,910	0,820	-	0,815
	14 PS	-	-	-	0,659	-
	15 PS	0,932	0,932	0,838	-	0,840
Annual energy consumption (kWh / year)	12 PS	258	258	230	-	230
	13 PS	261	261	234	-	234
	14 PS	-	-	-	189	-
	15 PS	267	267	239	-	241
Off mode power consumption (W)		0,50	0,50	0,10	0,10	0,50
Left-on mode power consumption (W)		1,00	1,00	1,00	1,00	1,00
Network standby mode power consumption (W)		N/A	N/A	N/A	N/A	N/A
Duration of left-on mode (min)		N/A	N/A	N/A	N/A	N/A

T3 SERIES 60cm Models BUILT-IN DISHWASHERS		T31	T32	T34	T35	T36
<b>Technical Data (4)</b>						
<b>Power rating (W) / Heating element (W)</b>		1900 / 1800	1900 / 1800	1900 / 1800	1900 / 1800	1900 / 1800
<b>Plug Type</b>		EU / UK / Swiss / Italy / Israel / AU/NZ / China / Argentina / S.Africa	EU / UK / Swiss / Italy / Israel / AU/NZ / China / Argentina / S.Africa	EU / UK / Swiss / Italy / Israel / AU/NZ / China / Argentina / S.Africa	EU / UK / Swiss / Italy / Israel / AU/NZ / China / Argentina / S.Africa	EU / UK / Swiss / Italy / Israel / AU/NZ / China / Argentina / S.Africa
<b>Power cord length (cm)</b>		165	165	165	165	165
<b>Water inlet hose length (cm)</b>	Default	147	147	147	147	147
	with Aquastop ext. hose	170	170	170	170	170
<b>Water outlet hose length (cm)</b>		200	200	200	200	200
<b>Voltage (V) / Frequency (Hz) / Fuse Rating (A)</b>		220-240 / 50 / 10	220-240 / 50 / 10	220-240 / 50 / 10	220-240 / 50 / 10	220-240 / 50 / 10
<b>Water pressure range (bar)</b>		0,3 - 10	0,3 - 10	0,3 - 10	0,3 - 10	0,3 - 10
<b>Dimensions</b>						
<b>Height (cm)</b>	Freestanding	85,0	85,0	85,0	85,0	85,0
	Semi-Integrated	82,0	82,0	82,0	82,0	82,0
	Fully Integrated	-	-	-	-	-
<b>Width (cm)</b>		59,8	59,8	59,8	59,8	59,8
<b>Depth (cm)</b>	Freestanding	59,8	59,8	59,8	59,8	59,8
	Semi-Integrated	57,0	57,0	57,0	57,0	57,0
	Fully Integrated	-	-	-	-	-
<b>Height adjustment (+cm)</b>	Freestanding	2	2	2	2	2
	Semi-Integrated	5	5	5	5	5
	Fully Integrated	-	-	-	-	-
<b>Adjustable Plinth for undertable usage (mm) Undertable</b>		(o) (80 or/and 130)	(o) (80 or/and 130)	(o) (80 or/and 130)	(o) (80 or/and 130)	(o) (80 or/and 130)
<b>Possible adjustment of the plinth Undertable (horizontal / vertical) (mm / mm)</b>		0-100 / 0-50	0-100 / 0-50	0-100 / 0-50	0-100 / 0-50	0-100 / 0-50
<b>Height without worktop (cm) Undertable</b>		82,0	82,0	82,0	82,0	82,0
<b>Decorative panel height (max) (cm) Semi-Integrated</b>		59,7	59,7	59,7	59,7	59,7
<b>Plinth height (min) (cm) Semi-Integrated</b>		8	8	8	8	8
<b>Plinth depth (cm) Semi-Integrated</b>		3 - 8	3 - 8	3 - 8	3 - 8	3 - 8
<b>Packed dimensions (Width x Depth x Height) (cm)</b>	Freestanding	64.4 x 66.1 x 88.1	64.4 x 66.1 x 88.1	64.4 x 66.1 x 88.1	64.4 x 66.1 x 88.1	64.4 x 66.1 x 88.1
	Semi-Integrated	64.4 x 66.1 x 85.1	64.4 x 66.1 x 85.1	64.4 x 66.1 x 85.1	64.4 x 66.1 x 85.1	64.4 x 66.1 x 85.1
	Fully Integrated	-	-	-	-	-
<b>Stacking quantity (pcs)</b>	Freestanding	6 (2 baskets) / 4 (3rd basket)	6 (2 baskets) / 4 (3rd basket)	6 (2 baskets) / 4 (3rd basket)	4	6 (2 baskets) / 4 (3rd basket)
	Semi-Integrated	6	6	6	6	6
	Fully Integrated	-	-	-	-	-
<b>Gross/Net weight (kg)(5)</b>	Freestanding	49 /46 - 56 /53	49 /46 - 56 /53	49 /46 - 56 /53	56 /53	49 /46 - 56 /53
	Semi-Integrated	43 /41	43 /41	43 /41	43 /41	43 /41
	Fully Integrated	-	-	-	-	-
<b>Container loading (40"HC / 40" / 20")</b>		162 /108 /54	162 /108 /54	162 /108 /54	162 /108 /54	162 /108 /54

Notes

(o) : Optional

(\*\*): Auto programme can be chosen instead of Intensive programme (with turbidity sensor)

(1): Turbo Fan feature & 3rd basket (& Aquazone for w/o diverter models) are default for 15 PS models.

For w/o diverter models; 3rd basket can be selected only with Aquazone.

Touch control is available with negative LCD display (Aron and Daphne only)"

(2) : Modular cutlery basket for 12/13 PS must be selected with wine stem support & spoon rack. Also wine stem support & spoon rack can be selected only for mesh type upper basket option.

(3) : Can be selected for lower basket with fixed type or with 4 foldable wire.

(4) : Based on the tests performed with Eco programme in accordance with European Household Dishwasher Performance Standards

(5) : Gross/Net Weights are shown as reference in the table. It should be calculated based on the final product features created from this general spect table.



60cm Models INTEGRATED		D13	D21	Z21	D22	D41	D46*	D43*
<b>General Characteristics</b>								
<b>Number of place settings (PS)(1)</b>	12 PS (2 baskets)	Default	Default	Default	Default	Default	Default	Default
	13 PS (2 baskets + 3rd rack)	(o)	(o)	(o)	(o)	(o)	(o)	(o)
	14 PS (2 baskets + 3rd rack)	(o) with Aquazone	(o) with Aquazone	(o) with Aquazone	(o) with Aquazone	(o)	(o)	(o)
	15 PS (2 baskets + 3rd rack)	(o) with Aquazone and Turbo fan	(o) with Aquazone and Turbo fan	(o) with Aquazone and Turbo fan	(o) with Aquazone and Turbo fan	(o) with Turbo fan	(o)	(o)
<b>Number of programmes</b>	4	5	5	6	9+	9+	9+	
<b>Temperatures (°C)</b>	50-65	40-50-65-70	40-50-65-70	40-50-65-70	Auto-30-40-50-60-70	Auto-30-40-50-60-65-70	Auto-30-40-50-60-65-70	
<b>Control type</b>	Default Option	Button Control -	Button Control -	Button Control -	Button Control -	Button Control -	Button Control -	
<b>Hidden heating element</b>		Yes	Yes	Yes	Yes	Yes	Yes	
<b>Filter type</b>	Metal Plastic	Default (o)	Default (o)	Default (o)	Default (o)	Default (o)	Default (o)	
<b>Tub material</b>		Stainless Steel	Stainless Steel	Stainless Steel	Stainless Steel	Stainless Steel	Stainless Steel	
<b>Turbidity sensor (Smart Wash)</b>		(o)	(o)	(o)	(o)	Yes	Yes	
<b>Drying system</b>	Mini Active	Default	Default	Default	Default	Default	-	
	Super Active	(o)	(o)	(o)	(o)	(o)	-	
	Turbo	(o)	(o)	(o)	(o)	(o)	Default	
<b>Electrical Diverter system</b>		-	-	-	-	Yes	Yes	
<b>Overflow &amp; leakage protection</b>		Yes	Yes	Yes	Yes	Yes	Yes	
<b>Heater protection</b>		Yes	Yes	Yes	Yes	Yes	Yes	
<b>Circulation pump</b>	Asynchronous BLDC	Yes -	Yes -	Yes -	Yes -	Yes -	Yes -	
<b>Auto Door</b>		-	-	-	-	-	-	
<b>Water Box</b>		-	-	-	-	-	-	
<b>Triple &amp; Direct Wash</b>		-	-	-	-	(o)	-	
<b>Aquazone</b>		(o)	(o)	(o)	(o)	-	-	
<b>New Indoor Design</b>		(o)	(o)	(o)	(o)	(o)	(o)	
<b>Sliding Door</b>		(o)	(o)	(o)	(o)	(o)	(o)	
<b>Ion Tech</b>		(o)	(o)	(o)	(o)	(o)	(o)	
<b>InfoLED</b>	1,0	-	-	-	-	(o)	(o)	
	2,0 (Floor Indicator)	(o)	(o)	(o)	(o)	(o)	(o)	
<b>Interior light</b>	one spot	-	(o)	(o)	(o)	(o)	(o)	
	four spot	(o)	(o)	(o)	(o)	(o)	(o)	
<b>Available Aesthetics</b>	Freestanding	-	-	-	-	-	-	
	Semi-Integrated	-	-	-	-	-	-	
	Fully Integrated	Astrum, Rhea, Rhea (Inox Cladding, Inox Half Cladding, Inox add-on)*	Astrum, Rhea, Rhea (Inox Cladding, Inox Half Cladding, Inox add-on)*	Astrum, Rhea, Rhea (Inox Cladding, Inox Half Cladding, Inox add-on)*	Astrum, Rhea, Rhea (Inox Cladding, Inox Half Cladding, Inox add-on)*	Astrum, Rhea, Rhea (Inox Cladding, Inox Half Cladding, Inox add-on)*	Astrum, Rhea, Rhea (Inox Cladding, Inox Half Cladding, Inox add-on)*	
<b>Programmes</b>								
<b>Prewash</b>		Yes	Yes	Yes	Yes	Yes	-	
<b>Mini 14' (Jet Wash)</b>		-	-	-	-	-	Yes	
<b>Quick 30' 40°C</b>		-	Yes	Yes	Yes	Yes	Yes	
<b>Eco (Standard Programme)</b>		Yes	Yes	Yes	Yes	Yes	Yes	
<b>Super 50' 65°C (Quick Clean)</b>		Yes	Yes	Yes	Yes	-	Yes	
<b>Super 55' 60°C</b>		-	-	-	-	Yes	-	
<b>Dual Pro Wash 60°C</b>		-	-	-	-	-	Yes	
<b>Hygiene 60°C</b>		-	-	-	-	Yes	-	
<b>Hygiene 70°C</b>		-	-	-	Yes	-	Yes	
<b>Intensive 65°C</b>		Yes	Yes	Yes	Yes	-	-	
<b>Auto*</b>		(o)	(o)	(o)	(o)	-	-	
<b>Auto Delicate 30°C - 50°C</b>		-	-	-	-	Yes	Yes	
<b>Auto Normal 50°C - 60°C / Auto Flex 50°C - 60°C</b>		-	-	-	-	Yes	Yes	
<b>Auto Intensive 60°C - 70°C</b>		-	-	-	-	Yes	Yes	
<b>Extra Hygiene 70°C (Prewash Button + Hygiene 60°C)</b>		-	-	-	-	Yes	-	
<b>Eco 5.4 lt / Save+ 5.4 lt</b>		-	-	-	-	-	-	
<b>User Interface</b>								
<b>DISPLAY TYPE (delay start, remaining time)</b>		-	-	LED One digit	LED One digit	LED Hidden display	LED Hidden display	
<b>Display Color</b>	Default Option	- -	- -	Red -	Red -	Red -	Red -	
<b>Prewash button</b>		-	-	-	-	Yes	-	
<b>Programme selection button</b>		Yes	Yes	Yes	Yes	Yes	Yes	
<b>Delay timer option</b>	3hr,6hr,9hr	-	Yes	Yes	Yes	-	-	
	1-2-3-...-19hr	-	-	-	-	Yes	Yes	
	1-2-3-...-24hr	-	-	-	-	-	-	
<b>Eco Wash - Half load option</b>	1 mode	-	-	Yes	-	-	-	
	3 modes	-	-	-	-	Yes	Yes	
<b>Tablet option</b>		-	-	Yes	-	Yes	Yes	
<b>Extra Rinse option</b>		-	-	-	-	-	-	
<b>Extra Silent option (Silent Wash)</b>		-	-	-	-	Yes	Yes	
<b>Extra Fast option</b>		-	-	-	-	Yes	-	
<b>Energy Save option</b>		-	-	-	-	-	Yes	
<b>Rinse-aid indicator</b>		Yes	Yes	Yes	Yes	Yes	Yes	
<b>Salt indicator</b>		Yes	Yes	Yes	Yes	Yes	Yes	
<b>Washing cycle indicators</b>		-	-	-	-	-	-	
<b>End of cycle indicator</b>		Yes	Yes	Yes	Yes	Yes	Yes	
<b>Buzzer</b>		Yes	Yes	Yes	Yes	Yes	Yes	
<b>Baskets &amp; Accessories</b>								
<b>3rd basket [EasyTray, EcoTray or Comfort Tray]</b>	12 PS	-	-	-	-	-	-	
	13 PS	(o)	(o)	(o)	(o)	(o)	(o)	
	14 PS	-	-	-	-	-	-	
	15 PS	Yes	Yes	Yes	Yes	Yes	Yes	
<b>Upper basket type [mesh type / peg type]</b>		(o)	(o)	(o)	(o)	(o)	(o)	
<b>Adjustable upper basket [empty/ loaded 2 level / loaded 3 level*]</b>		(o)	(o)	(o)	(o)	(o)	(o)	
<b>Number of mug shelves</b>		2 (std) / 4 (o)	2 (std) / 4 (o)	2 (std) / 4 (o)	2 (std) / 4 (o)	2 (std) / 4 (o)	2 (std) / 4 (o)	
<b>Adjustable mug shelves</b>		Yes (peg type) / (o) (mesh type)	Yes (peg type) / (o) (mesh type)	Yes (peg type) / (o) (mesh type)	Yes (peg type) / (o) (mesh type)	Yes (peg type) / (o) (mesh type)	Yes (peg type) / (o) (mesh type)	
<b>Mug shelves with soft touch rubber (only with peg type basket)</b>		(o)	(o)	(o)	(o)	(o)	(o)	
<b>Foldable racks on upper basket (only with peg type basket)</b>		fixed (std) / 2 or 4 or 6 (o)	fixed (std) / 2 or 4 or 6 (o)	fixed (std) / 2 or 4 or 6 (o)	fixed (std) / 2 or 4 or 6 (o)	fixed (std) / 2 or 4 or 6 (o)	fixed (std) / 2 or 4 or 6 (o)	
<b>Foldable racks on lower basket</b>		(o)	(o)	(o)	(o)	(o)	(o)	
<b>Upper basket handle type [No / Wire / Plastic / Metal]</b>		(o)	(o)	(o)	(o)	(o)	(o)	

60cm Models INTEGRATED		D45	D51	D52	D53	D55	D56*
<b>General Characteristics</b>							
<b>Number of place settings (PS)(1)</b>	12 PS (2 baskets)	-	Default	Default	Default	-	Default
	13 PS (2 baskets)	-	(o)	(o)	(o)	-	(o)
	13 PS (2 baskets + 3rd rack)	-	(o) with Aquazone	(o)	(o)	-	(o)
	14 PS (2 baskets + 3rd rack)	Default	-	-	-	Default	-
	15 PS (2 baskets + 3rd rack)	-	(o) with Aquazone and Turbo fan	(o) with Turbo fan	(o)	-	(o)
<b>Number of programmes</b>		9+	6	8+	8+	9+	9+
<b>Temperatures (°C)</b>		Auto-30-40-50-60-65-70	30-40-50-60-65	Auto-30-40-50-60-65-70	Auto-30-40-50-60-65-70	Auto-30-40-50-60-65-70	Auto-30-40-50-60-65-70
<b>Control type</b>	Default	Button Control	Touch Control	Touch Control	Touch Control	Touch Control	Touch Control
	Option	-	-	-	-	-	-
<b>Hidden heating element</b>		Yes	Yes	Yes	Yes	Yes	Yes
<b>Filter type</b>	Metal	Default	Default	Default	Default	Default	Default
	Plastic	-	(o)	(o)	-	-	-
<b>Tub material</b>		Stainless Steel	Stainless Steel	Stainless Steel	Stainless Steel	Stainless Steel	Stainless Steel
<b>Turbidity sensor (Smart Wash)</b>		Yes	(o)	Yes	Yes	Yes	Yes
<b>Drying system</b>	Mini Active	-	Default	Default	-	-	-
	Super Active	-	(o)	(o)	-	-	-
	Turbo	Default	(o)	(o)	Default	Default	Default
	Electrical Diverter system	Yes	-	Yes	Yes	Yes	Yes
<b>Overflow &amp; leakage protection</b>		Yes	Yes	Yes	Yes	Yes	Yes
<b>Heater protection</b>		Yes	Yes	Yes	Yes	Yes	Yes
<b>Circulation pump</b>	Asynchronous	-	Yes	Yes	-	-	-
	BLDC	Yes	-	-	Yes	Yes	Yes
<b>Auto Door</b>		Yes	-	-	Yes	Yes	-
<b>Water Box</b>		Yes	-	-	-	Yes	-
<b>Triple &amp; Direct Wash</b>		-	-	(o)	(o)	-	-
<b>Aquazone</b>		-	(o)	-	-	-	-
<b>New Indoor Design</b>		(o)	(o)	(o)	(o)	(o)	(o)
<b>Sliding Door</b>		(o)	(o)	(o)	(o)	(o)	(o)
<b>Ion Tech</b>		(o)	(o)	(o)	(o)	(o)	(o)
<b>InfoLED</b>	1,0	(o)	(o)	(o)	(o)	(o)	(o)
	2,0 (Floor Indicator)	(o)	(o)	(o)	(o)	(o)	(o)
<b>Interior light</b>	one spot	(o)	-	(o)	(o)	(o)	(o)
	four spot	(o)	-	(o)	(o)	(o)	(o)
<b>Available Aesthetics</b>	Freestanding	-	-	-	-	-	-
	Semi-Integrated	-	-	-	-	-	-
	Fully Integrated	Astrum, Rhea, Rhea (Inox Cladding, Inox Half Cladding, Inox add-on)*	Freya, Freya (Inox look)	Freya, Freya (Inox look)	Freya, Freya (Inox look)	Freya, Freya (Inox look)	Freya, Freya (Inox look)
<b>Programmes</b>							
<b>Mini 14' (Jet Wash)</b>		Yes	Yes	Yes	Yes	Yes	Yes
<b>Quick 30' 40°C</b>		Yes	Yes	Yes	Yes	Yes	Yes
<b>Eco (Standard Programme)</b>		Yes	Yes	Yes	Yes	Yes	Yes
<b>Super 50' 65°C (Quick Clean)</b>		Yes	Yes	Yes	Yes	Yes	Yes
<b>Super 55' 60°C</b>		-	-	-	-	-	-
<b>Dual Pro Wash 60°C</b>		Yes	-	-	Yes	Yes	Yes
<b>Hygiene 60°C</b>		-	-	-	-	-	-
<b>Hygiene 70°C</b>		Yes	Yes	Yes	Yes	Yes	Yes
<b>Intensive 65°C</b>		-	Yes	-	-	-	-
<b>Auto*</b>		-	(o)	-	-	-	-
<b>Auto Delicate 30°C - 50°C</b>		Yes	-	Yes	Yes	Yes	Yes
<b>Auto Normal 50°C - 60°C / Auto Flex 50°C - 60°C</b>		-	-	Yes	-	-	Yes
<b>Auto Intensive 60°C - 70°C</b>		Yes (50°C - 70°C)	-	Yes	Yes (50°C-70°C)	Yes (50°C - 70°C)	Yes
<b>Extra Hygiene 70°C (Prewash Button + Hygiene 60°C)</b>		-	-	-	-	-	-
<b>Eco 5.4 lt / Save+ 5.4 lt</b>		Yes	-	-	-	Yes	-
<b>User Interface</b>							
<b>DISPLAY TYPE (delay start, remaining time)</b>		LED Hidden display	LED Hidden display	LED Hidden display	LED Hidden display	LED Hidden display	LED Hidden display
<b>Display Color</b>	Default	Red	Blue	Blue	Blue	Blue	Blue
	Option	-	White	White	White	White	White
<b>Programme selection button</b>		Yes	Yes	Yes	Yes	Yes	Yes
<b>Delay timer option</b>	3hr,6hr,9hr	-	-	-	-	-	-
	1-2-3-...-19hr	Yes	Yes	Yes	Yes	Yes	Yes
	1-2-3-...-24hr	-	-	-	-	-	-
<b>Eco Wash - Half load option</b>	1 mode	-	Yes	-	-	-	-
	3 modes	Yes	-	Yes	Yes	Yes	Yes
<b>Tablet option</b>		Yes	Yes	Yes	Yes	Yes	Yes
<b>Extra Rinse option</b>		-	-	Yes	-	-	-
<b>Extra Silent option (Silent Wash)</b>		Yes	-	-	Yes	Yes	Yes
<b>Extra Fast option</b>		-	-	-	Yes	Yes	Yes
<b>Energy Save option</b>		Yes	-	-	Yes	Yes	-
<b>Rinse-aid indicator</b>		Yes	Yes	Yes	Yes	Yes	Yes
<b>Salt indicator</b>		Yes	Yes	Yes	Yes	Yes	Yes
<b>Washing cycle indicators</b>		-	-	-	-	-	-
<b>End of cycle indicator</b>		Yes	-	-	-	-	-
<b>Buzzer</b>		Yes	Yes	Yes	Yes	Yes	Yes
<b>Baskets &amp; Accessories</b>							
<b>3rd basket [EasyTray, EcoTray or Comfort Tray]</b>	12 PS	-	-	-	-	-	-
	13 PS	-	(o)	(o)	(o)	-	(o)
	14 PS	Yes	-	-	-	Yes	-
	15 PS	-	Yes	Yes	Yes	-	Yes
<b>Upper basket type [mesh type / peg type]</b>		Peg	(o)	(o)	(o)	Peg	(o)
<b>Adjustable upper basket [empty/ loaded 2 level / loaded 3 level*]</b>		(o)	(o)	(o)	(o)	(o)	(o)
<b>Number of mug shelves</b>		4	2 (std) / 4 (o)	2 (std) / 4 (o)	2 (std) / 4 (o)	4	2 (std) / 4 (o)
<b>Adjustable mug shelves</b>		Yes	Yes (peg type) / (o) (mesh type)	Yes (peg type) / (o) (mesh type)	Yes (peg type) / (o) (mesh type)	Yes	Yes (peg type) / (o) (mesh type)
<b>Mug shelves with soft touch rubber (only with peg type basket)</b>		(o)	(o)	(o)	(o)	(o)	(o)
<b>Foldable racks on upper basket (only with peg type basket)</b>		4 or 6 (o)	fixed (std) / 2 or 4 or 6 (o)	fixed (std) / 2 or 4 or 6 (o)	fixed (std) / 2 or 4 or 6 (o)	4 or 6 (o)	fixed (std) / 2 or 4 or 6 (o)
<b>Foldable racks on lower basket</b>		Yes	(o)	(o)	(o)	Yes	(o)
<b>Upper basket handle type [No / Wire / Plastic / Metal]</b>		-	(o)	(o)	(o)	-	(o)
<b>Lower basket handle type [No / Wire / Plastic / Metal]</b>		(o)	(o)	(o)	(o)	(o)	(o)

60cm Models INTEGRATED		D13	D21	Z21	D22	D41	D46*	D43*
<b>Baskets &amp; Accessories</b>								
Lower basket handle type [No / Wire / Plastic / Metal]		(o)	(o)	(o)	(o)	(o)	(o)	(o)
Removable cutlery basket (Single piece)		(o)(12/13ps) / No(15ps)	(o)(12/13ps) / No(15ps)	(o)(12/13ps) / No(15ps)	(o)(12/13ps) / No(15ps)	(o)(12/13ps) / No(15ps)	(o)(12/13ps) / No(15ps)	(o)(12/13ps) / No(15ps)
Removable cutlery basket (Universal)		No(12/13ps) / (o)(15ps)	No(12/13ps) / (o)(15ps)	No(12/13ps) / (o)(15ps)	No(12/13ps) / (o)(15ps)	No(12/13ps) / (o)(15ps)	No(12/13ps) / (o)(15ps)	No(12/13ps) / (o)(15ps)
Removable cutlery basket (Modular) (2)		(o)	(o)	(o)	(o)	(o)	(o)	(o)
Removable cutlery basket (Sliding) (3)		(o)(12/13ps) / No(15ps)	(o)(12/13ps) / No(15ps)	(o)(12/13ps) / No(15ps)	(o)(12/13ps) / No(15ps)	(o)(12/13ps) / No(15ps)	(o)(12/13ps) / No(15ps)	(o)(12/13ps) / No(15ps)
Multi functional kit (Extra mug shelves + higher rear part on lower basket)		(o)	(o)	(o)	(o)	(o)	(o)	(o)
Bottle holder on lower basket		(o)	(o)	(o)	(o)	(o)	(o)	(o)
Wine stem support & Spoon rack on upper basket (2)		(o)	(o)	(o)	(o)	(o)	(o)	(o)
Wine glass holder on lower basket		(o) with 4 foldable racks	(o) with 4 foldable racks	(o) with 4 foldable racks	(o) with 4 foldable racks	(o) with 4 foldable racks	(o) with 4 foldable racks	(o) with 4 foldable racks
Top nozzle	fixed type with 2 baskets	(o) with Aquazone	(o) with Aquazone	(o) with Aquazone	(o) with Aquazone	(o) with Aquazone	(o) with Aquazone	(o) with Aquazone
	rotating type	Default with 3rd basket	Default with 3rd basket	Default with 3rd basket	Default with 3rd basket	Default with 3rd basket	Default with 3rd basket	Default with 3rd basket
AquaStop external hose		(o)	(o)	(o)	(o)	(o)	(o)	(o)
Antibacterial filter		(o)	(o)	(o)	(o)	(o)	(o)	(o)
Anti-siphon system (Column mount option)		(o)	(o)	(o)	(o)	(o)	(o)	(o)
<b>Technical Data (4)</b>								
Sound level (dB(A) re 1 pW)	12 PS	57 / 54 / 52 / 49 / 47 / 45	57 / 54 / 52 / 49 / 47 / 45	57 / 54 / 52 / 49 / 47 / 45	57 / 54 / 52 / 49 / 47 / 45	57 / 54 / 52 / 49 / 47 / 45	49 / 47 / 45 / 44 / 42 / 41	46 / 44
	13 PS	57 / 54 / 52 / 49 / 47 / 45	57 / 54 / 52 / 49 / 47 / 45	57 / 54 / 52 / 49 / 47 / 45	57 / 54 / 52 / 49 / 47 / 45	57 / 54 / 52 / 49 / 47 / 45	49 / 47 / 45 / 44 / 42 / 41	46 / 44
	14 PS	-	-	-	-	-	-	-
	15 PS	49 / 47 / 45	49 / 47 / 45	49 / 47 / 45	49 / 47 / 45	49 / 47 / 45	49 / 47 / 45 / 44 / 42 / 41 / 39	44 / 42
Energy efficiency class		A++	A++	A++	A++	A++	A+++	A+++
Energy efficiency index	12 PS	55,8	55,8	55,8	55,8	55,8	49,7	49,7
	13 PS	55,6	55,6	55,6	55,6	55,6	49,9	49,9
	14 PS	-	-	-	-	-	-	-
	15 PS	55,9	55,9	55,9	55,9	55,3	49,9	49,9
Cleaning efficiency class		A	A	A	A	A	A	A
Cleaning efficiency index		1,13	1,13	1,13	1,13	1,13	1,13	1,13
Drying efficiency class		A	A	A	A	A	A	A
Drying efficiency index		1,09	1,09	1,09	1,09	1,09	1,09	1,09
Standard programme water consumption (lt / cycle)	Default	12,0	12,0	12,0	12,0	9,0	9,0	9,0
	with Aquazone	9,0	9,0	9,0	9,0	-	-	-
Annual water consumption (lt / year)	Default	3360	3360	3360	3360	2520	2520	2520
	with Aquazone	2520	2520	2520	2520	-	-	-
Duration of the standard programme (min)	Default	187	187	187	187	162	239	239
	with Aquazone	221	221	221	221	-	-	-
Standard programme energy consumption (kWh / cycle)	12 PS	0,900	0,900	0,900	0,900	0,899	0,800	0,800
	13 PS	0,910	0,910	0,910	0,910	0,910	0,815	0,815
	14 PS	-	-	-	-	-	-	-
	15 PS	0,943	0,943	0,943	0,943	0,932	0,840	0,840
Annual energy consumption (kWh / year)	12 PS	258	258	258	258	258	230	230
	13 PS	261	261	261	261	261	234	234
	14 PS	-	-	-	-	-	-	-
	15 PS	270	270	270	270	267	241	241
Off mode power consumption (W)		0,50	0,50	0,50	0,50	0,50	0,50	0,50
Left-on mode power consumption (W)		1,00	1,00	1,00	1,00	1,00	1,00	1,00
Network standby mode power consumption (W)		N/A	N/A	N/A	N/A	N/A	N/A	N/A
Duration of left-on mode (min)		N/A	N/A	N/A	N/A	N/A	N/A	N/A
Power rating (W) / Heating element (W)		1900 / 1800	1900 / 1800	1900 / 1800	1900 / 1800	1900 / 1800	1900 / 1800	1900 / 1800
Plug Type		EU / UK / Swiss / Italy / Israel / AU/NZ / China / Argentina / S.Africa	EU / UK / Swiss / Italy / Israel / AU/NZ / China / Argentina / S.Africa	EU / UK / Swiss / Italy / Israel / AU/NZ / China / Argentina / S.Africa	EU / UK / Swiss / Italy / Israel / AU/NZ / China / Argentina / S.Africa	EU / UK / Swiss / Italy / Israel / AU/NZ / China / Argentina / S.Africa	EU / UK / Swiss / Italy / Israel / AU/NZ / China / Argentina / S.Africa	EU / UK / Swiss / Italy / Israel / AU/NZ / China / Argentina / S.Africa
Power cord length (cm)		165	165	165	165	165	165	165
Water inlet hose length (cm)	Default	147	147	147	147	147	147	147
	with AquaStop ext. hose	170	170	170	170	170	170	170
Water outlet hose length (cm)		200	200	200	200	200	200	200
Voltage (V) / Frequency (Hz) / Fuse Rating (A)		220-240 / 50 / 10	220-240 / 50 / 10	220-240 / 50 / 10	220-240 / 50 / 10	220-240 / 50 / 10	220-240 / 50 / 10	220-240 / 50 / 10
Water pressure range (bar)		0,3 - 10	0,3 - 10	0,3 - 10	0,3 - 10	0,3 - 10	0,3 - 10	0,3 - 10
<b>Dimensions</b>								
Height (cm)	Freestanding	-	-	-	-	-	-	-
	Semi-Integrated	-	-	-	-	-	-	-
	Fully Integrated	82,0	82,0	82,0	82,0	82,0	82,0	82,0
Width (cm)		59,8	59,8	59,8	59,8	59,8	59,8	59,8
Depth (cm)	Freestanding	-	-	-	-	-	-	-
	Semi-Integrated	-	-	-	-	-	-	-
	Fully Integrated	55,0	55,0	55,0	55,0	55,0	55,0	55,0
Height adjustment (+cm)	Freestanding	-	-	-	-	-	-	-
	Semi-Integrated	-	-	-	-	-	-	-
	Fully Integrated	5	5	5	5	5	5	5
Decorative panel height (max) (cm) Fully-Integrated		71,7	71,7	71,7	71,7	71,7	71,7	71,7
Plinth height (min) (cm) Fully-Integrated		8	8	8	8	8	8	8
Plinth depth (cm) Fully-Integrated		3 - 8	3 - 8	3 - 8	3 - 8	3 - 8	3 - 8	3 - 8
Packed dimensions (Width x Depth x Height) (cm)	Freestanding	-	-	-	-	-	-	-
	Semi-Integrated	-	-	-	-	-	-	-
	Fully Integrated	64.4 x 66.1 x 85.1	64.4 x 66.1 x 85.1	64.4 x 66.1 x 85.1	64.4 x 66.1 x 85.1	64.4 x 66.1 x 85.1	64.4 x 66.1 x 85.1	64.4 x 66.1 x 85.1
Stacking quantity (pcs)	Freestanding	-	-	-	-	-	-	-
	Semi-Integrated	-	-	-	-	-	-	-
	Fully Integrated	6	6	6	6	6	6	6
Gross/Net weight (kg)(5)	Freestanding	-	-	-	-	-	-	-
	Semi-Integrated	-	-	-	-	-	-	-
	Fully Integrated	40 / 38	40 / 38	40 / 38	40 / 38	40 / 38	40 / 38	40 / 38
Container loading (40"HC/ 40" / 20")		162 / 108 / 54	162 / 108 / 54	162 / 108 / 54	162 / 108 / 54	162 / 108 / 54	162 / 108 / 54	162 / 108 / 54
<b>Sliding Door Dimensions</b>								
Sliding range (cm)		4 or 8	4 or 8	4 or 8	4 or 8	4 or 8	4 or 8	4 or 8
Decorative panel height (max) (cm)		75.7 or 79.7	75.7 or 79.7	75.7 or 79.7	75.7 or 79.7	75.7 or 79.7	75.7 or 79.7	75.7 or 79.7
Plinth height (min) (cm)		2 or 6	2 or 6	2 or 6	2 or 6	2 or 6	2 or 6	2 or 6
Plinth depth (cm)		0 - 8	0 - 8	0 - 8	0 - 8	0 - 8	0 - 8	0 - 8

60cm Models INTEGRATED		D45	D51	D52	D53	D55	D56*
<b>Baskets &amp; Accessories</b>							
<b>Removable cutlery basket (Single piece)</b>		-	(o)(12/13ps) / No(15ps)	(o)(12/13ps) / No(15ps)	(o)(12/13ps) / No(15ps)	-	(o)(12/13ps) / No(15ps)
<b>Removable cutlery basket (Universal)</b>		(o)	No(12/13ps) / (o)(15ps)	No(12/13ps) / (o)(15ps)	No(12/13ps) / (o)(15ps)	(o)	No(12/13ps) / (o)(15ps)
<b>Removable cutlery basket (Modular) (2)</b>		(o)	(o)	(o)	(o)	(o)	(o)
<b>Removable cutlery basket (Sliding) (3)</b>		-	(o)(12/13ps) / No(15ps)	(o)(12/13ps) / No(15ps)	(o)(12/13ps) / No(15ps)	-	(o)(12/13ps) / No(15ps)
<b>Multi functional kit (Extra mug shelves + higher rear part on lower basket)</b>		(o)	(o)	(o)	(o)	(o)	(o)
<b>Bottle holder on lower basket</b>		(o)	(o)	(o)	(o)	(o)	(o)
<b>Wine stem support &amp; Spoon rack on upper basket (2)</b>		-	(o)	(o)	(o)	-	(o)
<b>Wine glass holder on lower basket</b>		(o) with 4 foldable racks	(o) with 4 foldable racks	(o) with 4 foldable racks	(o) with 4 foldable racks	(o) with 4 foldable racks	(o) with 4 foldable racks
<b>Top nozzle</b>	fixed type with 2 baskets	-	(o) with Aquazone	(o)	(o)	-	(o)
	rotating type	Default	Default with 3rd basket	Default with 3rd basket	Default with 3rd basket	Default	Default with 3rd basket
<b>Aquastop external hose</b>		(o)	(o)	(o)	(o)	(o)	(o)
<b>Antibacterial filter</b>		(o)	(o)	(o)	(o)	(o)	(o)
<b>Anti-siphon system (Column mount option)</b>		(o)	(o)	(o)	(o)	(o)	(o)
<b>Technical Data (4)</b>							
<b>Sound level (dB(A) re 1 pW)</b>	12 PS	-	57 / 54 / 52 / 49 / 47 / 45	57 / 54 / 52 / 49 / 47 / 45	46 / 44	-	49 / 47 / 45 / 44 / 42 / 41
	13 PS	-	57 / 54 / 52 / 49 / 47 / 45	57 / 54 / 52 / 49 / 47 / 45	46 / 44	-	49 / 47 / 45 / 44 / 42 / 41
	14 PS	44	-	-	-	44	-
	15 PS	-	49 / 47 / 45	49 / 47 / 45	44 / 42	-	49 / 47 / 45 / 44 / 42 / 41 / 39
<b>Energy efficiency class</b>		A+++ -20%	A++	A++	A+++	A+++ -20%	A+++
<b>Energy efficiency index</b>	12 PS	-	55,8	55,8	49,8	-	49,7
	13 PS	-	55,6	55,6	49,9	-	49,9
	14 PS	39,7	-	-	-	39,7	-
	15 PS	-	55,9	55,3	49,5	-	49,9
<b>Cleaning efficiency class</b>		A	A	A	A	A	A
<b>Cleaning efficiency index</b>		1,13	1,13	1,13	1,13	1,13	1,13
<b>Drying efficiency class</b>		A	A	A	A	A	A
<b>Drying efficiency index</b>		1,09	1,09	1,09	1,09	1,09	1,09
<b>Standard programme water consumption (lt / cycle)</b>	Default	9,0	12,0	9,0	9,0	9,0	9,0
	with Aquazone	-	9,0	-	-	-	-
<b>Annual water consumption (lt / year)</b>	Default	2520	3360	2520	2520	2520	2520
	with Aquazone	-	2520	-	-	-	-
<b>Duration of the standard programme (min)</b>	Default	228	187	171	195 (239 for lower dB(A))	228	239
	with Aquazone	-	221	-	-	-	-
<b>Standard programme energy consumption (kWh / cycle)</b>	12 PS	-	0,900	0,900	0,800	-	0,800
	13 PS	-	0,910	0,910	0,814	-	0,815
	14 PS	0,654	-	-	-	0,654	-
	15 PS	-	0,943	0,932	0,832	-	0,840
<b>Annual energy consumption (kWh / year)</b>	12 PS	-	258	258	230	-	230
	13 PS	-	261	261	234	-	234
	14 PS	189	-	-	-	189	-
	15 PS	-	270	267	239	-	241
<b>Off mode power consumption (W)</b>		0,50	0,50	0,50	0,50	0,50	0,50
<b>Left-on mode power consumption (W)</b>		1,00	1,00	1,00	1,00	1,00	1,00
<b>Network standby mode power consumption (W)</b>		N/A	N/A	N/A	N/A	N/A	N/A
<b>Duration of left-on mode (min)</b>		N/A	N/A	N/A	N/A	N/A	N/A
<b>Power rating (W) / Heating element (W)</b>		1900 / 1800	1900 / 1800	1900 / 1800	1900 / 1800	1900 / 1800	1900 / 1800
<b>Plug Type</b>		EU / UK / Swiss / Italy / Israel / AU/NZ / China / Argentina / S.Africa	EU / UK / Swiss / Italy / Israel / AU/NZ / China / Argentina / S.Africa	EU / UK / Swiss / Italy / Israel / AU/NZ / China / Argentina / S.Africa	EU / UK / Swiss / Italy / Israel / AU/NZ / China / Argentina / S.Africa	EU / UK / Swiss / Italy / Israel / AU/NZ / China / Argentina / S.Africa	EU / UK / Swiss / Italy / Israel / AU/NZ / China / Argentina / S.Africa
<b>Power cord length (cm)</b>		165	165	165	165	165	165
<b>Water inlet hose length (cm)</b>	Default	147	147	147	147	147	147
	with Aquastop ext. hose	170	170	170	170	170	170
<b>Water outlet hose length (cm)</b>		200	200	200	200	200	200
<b>Voltage (V) / Frequency (Hz) / Fuse Rating (A)</b>		220-240 / 50 / 10	220-240 / 50 / 10	220-240 / 50 / 10	220-240 / 50 / 10	220-240 / 50 / 10	220-240 / 50 / 10
<b>Water pressure range (bar)</b>		0,3 - 10	0,3 - 10	0,3 - 10	0,3 - 10	0,3 - 10	0,3 - 10
<b>Dimensions</b>							
<b>Height (cm)</b>	Freestanding	-	-	-	-	-	-
	Semi-Integrated	-	-	-	-	-	-
	Fully Integrated	82,0	82,0	82,0	82,0	82,0	82,0
<b>Width (cm)</b>	Freestanding	59,8	59,8	59,8	59,8	59,8	59,8
	Semi-Integrated	-	-	-	-	-	-
	Fully Integrated	55,0	55,0	55,0	55,0	55,0	55,0
<b>Depth (cm)</b>	Freestanding	-	-	-	-	-	-
	Semi-Integrated	-	-	-	-	-	-
	Fully Integrated	55,0	55,0	55,0	55,0	55,0	55,0
<b>Height adjustment (+cm)</b>	Freestanding	-	-	-	-	-	-
	Semi-Integrated	-	-	-	-	-	-
	Fully Integrated	5	5	5	5	5	5
<b>Decorative panel height (max) (cm) Fully-Integrated</b>		71,7	71,7	71,7	71,7	71,7	71,7
<b>Plinth height (min) (cm) Fully-Integrated</b>		8	8	8	8	8	8
<b>Plinth depth (cm) Fully-Integrated</b>		3 - 8	3 - 8	3 - 8	3 - 8	3 - 8	3 - 8
<b>Packed dimensions (Width x Depth x Height) (cm)</b>	Freestanding	-	-	-	-	-	-
	Semi-Integrated	-	-	-	-	-	-
	Fully Integrated	64.4 x 66.1 x 85.1	64.4 x 66.1 x 85.1	64.4 x 66.1 x 85.1	64.4 x 66.1 x 85.1	64.4 x 66.1 x 85.1	64.4 x 66.1 x 85.1
<b>Stacking quantity (pcs)</b>	Freestanding	-	-	-	-	-	-
	Semi-Integrated	-	-	-	-	-	-
	Fully Integrated	6	6	6	6	6	6
<b>Gross/Net weight (kg)(5)</b>	Freestanding	-	-	-	-	-	-
	Semi-Integrated	-	-	-	-	-	-
	Fully Integrated	40 / 38	40 / 38	40 / 38	40 / 38	40 / 38	40 / 38
<b>Container loading (40"HC/ 40" / 20")</b>		162 / 108 / 54	162 / 108 / 54	162 / 108 / 54	162 / 108 / 54	162 / 108 / 54	162 / 108 / 54
<b>Sliding Door Dimensions</b>							
<b>Sliding range (cm)</b>		4 or 8	4 or 8	4 or 8	4 or 8	4 or 8	4 or 8
<b>Decorative panel height (max) (cm)</b>		75.7 or 79.7	75.7 or 79.7	75.7 or 79.7	75.7 or 79.7	75.7 or 79.7	75.7 or 79.7
<b>Plinth height (min) (cm)</b>		2 or 6	2 or 6	2 or 6	2 or 6	2 or 6	2 or 6
<b>Plinth depth (cm)</b>		0 - 8	0 - 8	0 - 8	0 - 8	0 - 8	0 - 8

(a) : Optional (\*) : See roadmap for availability

(\*\*) : Auto programme can be chosen instead of Intensive programme (with turbidity sensor).

(1) : Turbo Fan feature & 3rd basket (& Aquazone for w/o diverter models) are default for 15 PS models. For w/o diverter models; 3rd basket can be selected only with Aquazone

(2) : Modular cutlery basket for 12/13 PS must be selected with wine stem support & spoon rack. Also wine stem support & spoon rack can be selected only for mesh type upper basket option.

(3) : Can be selected for lower basket with fixed type or with 4 foldable wire.

(4) : Based on the tests performed with Eco programme in accordance with European Household Dishwasher Performance Standards

(5) : Gross/Net Weights are shown as reference in the table. It should be calculated based on the final product features created from this general spec table.



Z Series (Top control) 60 cm Models		ZA5	ZB7	ZA5 BLDC*	ZB7 BLDC*
<b>General Characteristics</b>					
Number of place settings (PS)		Standard	Standard	Standard	Standard
Number of programmes		6	8	6	8
Control type	Default	Button Control	Button Control	Button Control	Button Control
	Option	Touch Control (1)	Touch Control (1)	Touch Control (1)	Touch Control (1)
Hidden heating element		Yes	Yes	Yes	Yes
Filter type	Metal	Default	Default	Default	Default
	Plastic	(o)	(o)	(o)	(o)
Tub material		Stainless Steel	Stainless Steel	Stainless Steel	Stainless Steel
Tub Type [Tall Tub/ Normal Tub]		(o)	(o)	(o)	(o)
Turbidity sensor (Smart Wash)		Yes	Yes	Yes	Yes
Drying system	Mini Active	Default	Default	Default	Default
	Super Active	(o)	(o)	(o)	(o)
	Turbo	(o)	(o)	(o)	(o)
Electrical Diverter system		-	Yes	-	Yes
Water Regeneration system		(o)	(o)	(o)	(o)
Overflow & leakage protection		Yes	Yes	Yes	Yes
Heater protection		Yes	Yes	Yes	Yes
Circulation pump	Asynchronous	Asynchronous	Asynchronous	-	-
	BLDC	-	-	BLDC	BLDC
Auto Door		-	-	-	-
Water Box		-	-	-	-
Direct Wash		-	-	-	-
Wi-fi		-	-	-	-
New Indoor Design		Yes	Yes	Yes	Yes
Sliding Door		-	-	-	-
Ion Tech		-	-	-	-
Uvon Tech		-	-	-	-
InfoLED	1,0	-	-	-	-
	2.0 (Floor Indicator)	-	-	-	-
Interior light	one spot	-	-	-	-
	four spot	-	-	-	-
Available Aesthetics	Front Control	-	-	-	-
	Top Control	Anjer	Anjer	Anjer	Anjer
	Integrated	Rhea, Astrum	Rhea, Astrum	Rhea, Astrum	Rhea, Astrum
Appliance Color Options for Anjer Aesthetic		Black, White, Inox	Black, White, Inox	Black, White, Inox	Black, White, Inox
<b>Programmes</b>					
P1. Regular		Yes	Yes	Yes	Yes
P2. Intensive		Yes	Yes	Yes	Yes
P3. Super		Yes	Yes	Yes	Yes
P4. Auto		Yes	Yes	Yes	Yes
P5. Rinse		Yes	Yes	Yes	Yes
P6. Delicate		Yes	Yes	Yes	Yes
P7. Daily		-	Yes	-	Yes
P8. Intensive Plus		-	Yes	-	Yes
<b>User Interface</b>					
Start/Pause button		Yes	Yes	Yes	Yes
DISPLAY (delay start, remaining time)		Yes: LED	Yes: LED	Yes: LED	Yes: LED
Display Color	Default	Red	Red	Red	Red
	Option	-	-	-	-
Prewash button		-	-	-	-
Programme selection button		Yes	Yes	Yes	Yes
Delay timer option	3hr,6hr,9hr	-	-	-	-
	1-2-3-...-19hr	Yes (1-2-3-...-19hr)	Yes (1-2-3-...-19hr)	Yes (1-2-3-...-19hr)	Yes (1-2-3-...-19hr)
	1-2-3-...-24hr	-	-	-	-
Eco Wash - Half load option	1 mode	Yes	-	Yes	-
	3 modes	-	Yes	-	Yes
Hi-Temp option		Yes	Yes	Yes	Yes
Sanitize option		Yes	Yes	Yes	Yes
Extra Rinse option		Yes	Yes	-	-
Extra Drying option		Yes	Yes	-	-
Extra Silent		-	-	Yes	Yes
Extra Fast		-	-	Yes	Yes
Rinse-aid indicator		Yes	Yes	Yes	Yes
Salt indicator or Power on indicator		Yes	Yes	Yes	Yes
Washing cycle indicators		-	-	-	-
End of cycle indicator		Yes	Yes	Yes	Yes
Child Lock		-	-	-	-
Buzzer		Yes	Yes	Yes	Yes

Z Series (Top control) 60 cm Models		ZA5	ZB7	ZA5 BLDC*	ZB7 BLDC*
<b>Baskets &amp; Accessories</b>					
3rd basket [EasyTray, EcoTray or Flex Tray]		-	(o)	-	(o)
Upper basket type		Peg Type	Peg Type	Peg Type	Peg Type
Adjustable upper basket [empty/ loaded 2 level / loaded 3 level]		(o)	(o)	(o)	(o)
Number of mug shelves		2 (std) / 4 (o)	2 (std) / 4 (o)	2 (std) / 4 (o)	2 (std) / 4 (o)
Adjustable mug shelves		Yes	Yes	Yes	Yes
Mug shelves with soft touch rubber		(o)	(o)	(o)	(o)
Foldable racks on upper basket		fixed (std) / 2 or 4 or 6 (o)	fixed (std) / 2 or 4 or 6 (o)	fixed (std) / 2 or 4 or 6 (o)	fixed (std) / 2 or 4 or 6 (o)
Foldable racks on lower basket		(o)	(o)	(o)	(o)
Upper basket handle type [No / Wire / Plastic / Metal]		-	-	-	-
Lower basket handle type [No / Wire / Plastic / Metal]		-	-	-	-
Removable cutlery basket		Yes	Yes	Yes	Yes
Multi functional kit (Extra mug shelves + higher rear part on lower basket)		(o)	(o)	(o)	(o)
Bottle holder on lower basket		(o)	(o)	(o)	(o)
Wine stem support & Spoon rack on upper basket		-	-	-	-
Wine glass holder on lower basket		(o)	(o)	(o)	(o)
Top nozzle	fixed type with 2 baskets	-	(o)	-	(o)
	rotating type	-	Default with 3rd basket	-	Default with 3rd basket
AquaStop external hose		-	-	-	-
Antibacterial filter		-	-	-	-
Anti-siphon system		Yes	Yes	Yes	Yes
<b>Technical Data</b>					
Noise Level (dB(A))		51 / 53 / 55 / 57	51 / 53 / 55 / 57	44 / 45 / 47 / 49	44 / 45 / 47 / 49
Energy Star		Yes	Yes	Yes	Yes
Water consumption (gal)		≤ 3,5	≤ 3,5	≤ 3,5	≤ 3,5
Annual energy consumption (kWh / year)		≤ 270	≤ 270	≤ 270	≤ 270
Duration of the standard programme (min)		122-145	122-145	122-145	122-145
Power rating (W) / Heating element (W)		1400 / 1100	1400 / 1100	1400 / 1100	1400 / 1100
Plug Type		USA	USA	USA	USA
Power cord length (cm)		116	116	116	116
Water inlet hose length (cm)		-	-	-	-
Water outlet hose length (cm)		76 3/4" (1950 mm)	76 3/4" (1950 mm)	76 3/4" (1950 mm)	76 3/4" (1950 mm)
Voltage (V) / Frequency (Hz) / Fuse Rating (A)		120V / 60 / 12	120V / 60 / 12	120V / 60 / 12	120V / 60 / 12
Water pressure range (bar)		0.3 - 10	0.3 - 10	0.3 - 10	0.3 - 10
<b>Dimensions</b>					
Height (mm)	Tall Tub	33 7/8" (861 mm)	33 7/8" (861 mm)	33 7/8" (861 mm)	33 7/8" (861 mm)
	Normal Tub	32 9/32" (820 mm)	32 9/32" (820 mm)	32 9/32" (820 mm)	32 9/32" (820 mm)
Width (mm)		23 9/16" (598 mm)	23 9/16" (598 mm)	23 9/16" (598 mm)	23 9/16" (598 mm)
Depth (mm)		22 1/2" (570 mm)	22 1/2" (570 mm)	22 1/2" (570 mm)	22 1/2" (570 mm)
Height adjustment (+cm)		5	5	5	5
Adjustable Plinth for undertable usage (mm)		80,0	80,0	80,0	80,0
<b>Cut-Out Dimensions</b>					
Width (inch / mm) - Min		24" (610 mm)	24" (610 mm)	24" (610 mm)	24" (610 mm)
Height (inch / mm) - Min	Tall Tub	34 " (864 mm)	34 " (864 mm)	34 " (864 mm)	34 " (864 mm)
	Normal Tub	32 43/68" (830 mm)	32 43/68" (830 mm)	32 43/68" (830 mm)	32 43/68" (830 mm)
Height (inch / mm) - Max	Tall Tub	36 1/4 " (920 mm)	36 1/4 " (920 mm)	36 1/4 " (920 mm)	36 1/4 " (920 mm)
	Normal Tub	34 41/64" (880 mm)	34 41/64" (880 mm)	34 41/64" (880 mm)	34 41/64" (880 mm)
Depth (inch / mm) - Min		24" (610 mm)	24" (610 mm)	24" (610 mm)	24" (610 mm)

Notes

(o) : Optional

(\*) : See roadmap for availability

(†) : Touch Control is only available with Freya Aesthetic.

\* Version Naming:

- Character Y : Front Control system  
Z : Top Control system
- Character 1 : without Electrical diverter motor  
2 : with Electrical diverter moto  
A : without Electrical diverter motor ,with display board  
B : with Electrical diverter motor, with display board
- Character 1 : Standard Version (2 Programs)  
2 : +1 program cycle  
3 : +2 program cycle  
4 : +3 program cycle  
5 : +4 program cycle  
6 : +5 program cycle  
7 : +6 program cycle

A1 SERIES 45cm Models BUILT-IN DISHWASHERS		A12 45cm	A1B 45cm	A13 45cm	A1C 45cm	A14 45cm	A1D 45cm	A15 45cm	A1E 45cm
<b>General Characteristics</b>									
<b>Number of place settings (PS)</b>	10 PS (2 baskets)	Default	Default	Default	Default	Default	Default	Default	Default
	10 PS (2 baskets + 3rd rack)	-	-	-	-	-	-	-	-
<b>Number of programmes</b>		3	3	4	4	5	5	6	6
<b>Temperatures (°C)</b>		50-65	50-65	50-65	50-65	40-50-65-70	40-50-65-70	40-50-65-70	40-50-65-70
<b>Control type</b>	Default	Button Control	Button Control	Button Control	Button Control	Button Control	Button Control	Button Control	Button Control
	Option	-	-	-	-	-	-	-	-
<b>Hidden heating element</b>		Yes	Yes	Yes	Yes	Yes	Yes	Yes	Yes
<b>Filter type</b>	Metal	Default	Default	Default	Default	Default	Default	Default	Default
	Plastic	-	-	-	-	-	-	-	-
<b>Tub material</b>		Stainless Steel	Stainless Steel	Stainless Steel	Stainless Steel	Stainless Steel	Stainless Steel	Stainless Steel	Stainless Steel
<b>Turbidity sensor (Smart Wash)</b>		-	-	-	-	-	-	-	-
<b>Drying system</b>	Mini Active	Default	Default	Default	Default	Default	Default	Default	Default
	Super Active	(o)	(o)	(o)	(o)	(o)	(o)	(o)	(o)
	Turbo	-	-	-	-	-	-	-	-
<b>Electrical Diverter system</b>		-	-	-	-	-	-	-	-
<b>Overflow &amp; leakage protection</b>		Yes	Yes	Yes	Yes	Yes	Yes	Yes	Yes
<b>Heater protection</b>		Yes	Yes	Yes	Yes	Yes	Yes	Yes	Yes
<b>Circulation pump</b>	Asynchronous	Yes	Yes	Yes	Yes	Yes	Yes	Yes	Yes
	BLDC	-	-	-	-	-	-	-	-
<b>Aquazone *</b>		(o)	(o)	(o)	(o)	(o)	(o)	(o)	(o)
<b>Available Aesthetics</b>	Freestanding	Angel	Angel	Angel	Angel	Angel	Angel	Angel	Angel
	Semi-Integrated	-	-	-	-	-	-	-	-
	Fully Integrated	-	-	-	-	-	-	-	-
<b>Appliance Color Options</b>		Black, Dark Gray, Dark Inox, Dark Silver, Inox, White	Black, Dark Gray, Dark Inox, Dark Silver, Inox, White	Black, Dark Gray, Dark Inox, Dark Silver, Inox, White	Black, Dark Gray, Dark Inox, Dark Silver, Inox, White	Black, Dark Gray, Dark Inox, Dark Silver, Inox, White	Black, Dark Gray, Dark Inox, Dark Silver, Inox, White	Black, Dark Gray, Dark Inox, Dark Silver, Inox, White	Black, Dark Gray, Dark Inox, Dark Silver, Inox, White
<b>Programmes</b>									
<b>Prewash</b>		-	-	-	-	-	-	Yes	Yes
<b>Quick 30' 40°C</b>		-	-	Yes	Yes	Yes	Yes	Yes	Yes
<b>Eco (Standard Programme)</b>		Yes	Yes	Yes	Yes	Yes	Yes	Yes	Yes
<b>Super 50' 65°C (Quick Clean)</b>		Yes	Yes	Yes	Yes	Yes	Yes	Yes	Yes
<b>Hygiene 70°C</b>		-	-	-	-	Yes	Yes	Yes	Yes
<b>Intensive 65°C</b>		Yes	Yes	Yes	Yes	Yes	Yes	Yes	Yes
<b>Auto*</b>		(o)	(o)	(o)	(o)	(o)	(o)	(o)	(o)
<b>User Interface</b>									
<b>Start/Pause button</b>		Yes	Yes	Yes	Yes	Yes	Yes	Yes	Yes
<b>DISPLAY TYPE (delay start, remaining time)</b>		-	Mini: LED	-	Mini: LED	-	Mini: LED	-	Mini: LED
<b>Display Color</b>	Default	-	Red	-	Red	-	Red	-	Red
	Option	-	White	-	White	-	White	-	White
<b>Prewash button</b>		-	-	-	-	-	-	-	-
<b>Programme selection button</b>		Yes	Yes	Yes	Yes	Yes	Yes	Yes	Yes
<b>User Interface</b>									
<b>Delay timer option</b>	3hr,6hr,9hr	Yes	-	Yes	-	Yes	-	Yes	-
	1-2-3-...-19hr	-	-	-	-	-	-	-	-
	1-2-3-...-24hr	-	Yes	-	Yes	-	Yes	-	Yes
<b>Eco Wash - Half load option</b>	1 mode	Yes	Yes	Yes	Yes	Yes	Yes	Yes	Yes
	3 modes	-	-	-	-	-	-	-	-
<b>Tablet option</b>		Yes	Yes	Yes	Yes	Yes	Yes	Yes	Yes
<b>Rinse-aid indicator</b>		Yes	Yes	Yes	Yes	Yes	Yes	Yes	Yes
<b>Salt indicator</b>		Yes	Yes	Yes	Yes	Yes	Yes	Yes	Yes
<b>Washing cycle indicators</b>		Yes	Yes	Yes	Yes	Yes	Yes	Yes	Yes
<b>End of cycle indicator</b>		Yes	Yes	Yes	Yes	Yes	Yes	Yes	Yes
<b>Child Lock</b>		Yes	Yes	Yes	Yes	Yes	Yes	Yes	Yes
<b>Buzzer</b>		(o)	(o)	(o)	(o)	(o)	(o)	(o)	(o)

A1 SERIES 45cm Models BUILT-IN DISHWASHERS		A12 45cm	A1B 45cm	A13 45cm	A1C 45cm	A14 45cm	A1D 45cm	A15 45cm	A1E 45cm
<b>Baskets &amp; Accessories</b>									
Upper basket type		Peg	Peg	Peg	Peg	Peg	Peg	Peg	Peg
Adjustable upper basket [empty/ loaded 2 level / loaded 3 level*]		(o)	(o)	(o)	(o)	(o)	(o)	(o)	(o)
Number of mug shelves		4 (std)	4 (std)	4 (std)	4 (std)	4 (std)	4 (std)	4 (std)	4 (std)
Adjustable mug shelves		-	-	-	-	-	-	-	-
Mug shelves with soft touch rubber		(o)	(o)	(o)	(o)	(o)	(o)	(o)	(o)
Foldable racks on upper basket		(o)	(o)	(o)	(o)	(o)	(o)	(o)	(o)
Foldable racks on lower basket		(o)	(o)	(o)	(o)	(o)	(o)	(o)	(o)
Upper basket handle type [No / Plastic / Metal]		(o)	(o)	(o)	(o)	(o)	(o)	(o)	(o)
Lower basket handle type [No / Plastic / Metal]		(o)	(o)	(o)	(o)	(o)	(o)	(o)	(o)
Removable cutlery basket (Universal)		Yes	Yes	Yes	Yes	Yes	Yes	Yes	Yes
Wine glass holder on lower basket		(o) with foldable racks	(o) with foldable racks	(o) with foldable racks	(o) with foldable racks	(o) with foldable racks	(o) with foldable racks	(o) with foldable racks	(o) with foldable racks
Top nozzle	fixed type with 2 baskets	Default	Default	Default	Default	Default	Default	Default	Default
	rotating type	-	-	-	-	-	-	-	-
AquaStop external hose		(o)	(o)	(o)	(o)	(o)	(o)	(o)	(o)
Antibacterial filter		(o)	(o)	(o)	(o)	(o)	(o)	(o)	(o)
<b>Technical Data (2)</b>									
Sound level (dB(A) re 1 pW)	10 PS	57 / 54 / 52 / 49 / 47 / 45	57 / 54 / 52 / 49 / 47 / 45	57 / 54 / 52 / 49 / 47 / 45	57 / 54 / 52 / 49 / 47 / 45	57 / 54 / 52 / 49 / 47 / 45	57 / 54 / 52 / 49 / 47 / 45	57 / 54 / 52 / 49 / 47 / 45	57 / 54 / 52 / 49 / 47 / 45
Energy efficiency class		A++	A++	A++	A++	A++	A++	A++	A++
Energy efficiency index	10 PS	55,8	55,8	55,8	55,8	55,8	55,8	55,8	55,8
Cleaning efficiency class		A	A	A	A	A	A	A	A
Cleaning efficiency index		1,13	1,13	1,13	1,13	1,13	1,13	1,13	1,13
Drying efficiency class		A	A	A	A	A	A	A	A
Drying efficiency index		1,09	1,09	1,09	1,09	1,09	1,09	1,09	1,09
Standard programme water consumption (lt / cycle)	Default	11,0	11,0	11,0	11,0	11,0	11,0	11,0	11,0
	with Aquazone	9,0	9,0	9,0	9,0	9,0	9,0	9,0	9,0
Annual water consumption (lt / year)	Default	3080	3080	3080	3080	3080	3080	3080	3080
	with Aquazone	2520	2520	2520	2520	2520	2520	2520	2520
Duration of the standard programme (min)	Default	198	198	198	198	198	198	198	198
	with Aquazone	222	222	222	222	222	222	222	222
Standard programme energy consumption (kWh / cycle)	10 PS	0,732	0,732	0,732	0,732	0,732	0,732	0,732	0,732
Annual energy consumption (kWh / year)	10 PS	211	211	211	211	211	211	211	211
Off mode power consumption (W)		0,50	0,50	0,50	0,50	0,50	0,50	0,50	0,50
Left-on mode power consumption (W)		1,00	1,00	1,00	1,00	1,00	1,00	1,00	1,00
Network standby mode power consumption (W)		N/A	N/A	N/A	N/A	N/A	N/A	N/A	N/A
Duration of left-on mode (min)		15	15	15	15	15	15	15	15
Power rating (W) / Heating element (W)		1900 / 1800	1900 / 1800	1900 / 1800	1900 / 1800	1900 / 1800	1900 / 1800	1900 / 1800	1900 / 1800
Plug Type		EU / UK / Swiss / Italy / Israel / AU/NZ / China / Argentina / S.Africa	EU / UK / Swiss / Italy / Israel / AU/NZ / China / Argentina / S.Africa	EU / UK / Swiss / Italy / Israel / AU/NZ / China / Argentina / S.Africa	EU / UK / Swiss / Italy / Israel / AU/NZ / China / Argentina / S.Africa	EU / UK / Swiss / Italy / Israel / AU/NZ / China / Argentina / S.Africa	EU / UK / Swiss / Italy / Israel / AU/NZ / China / Argentina / S.Africa	EU / UK / Swiss / Italy / Israel / AU/NZ / China / Argentina / S.Africa	EU / UK / Swiss / Italy / Israel / AU/NZ / China / Argentina / S.Africa
Power cord length (cm)		165	165	165	165	165	165	165	165
Water inlet hose length (cm)	Default	147	147	147	147	147	147	147	147
	with AquaStop ext. hose	170	170	170	170	170	170	170	170
Water outlet hose length (cm)		200	200	200	200	200	200	200	200
Voltage (V) / Frequency (Hz) / Fuse Rating (A)		220-240 / 50 / 10	220-240 / 50 / 10	220-240 / 50 / 10	220-240 / 50 / 10	220-240 / 50 / 10	220-240 / 50 / 10	220-240 / 50 / 10	220-240 / 50 / 10
Water pressure range (bar)		0,3 - 10	0,3 - 10	0,3 - 10	0,3 - 10	0,3 - 10	0,3 - 10	0,3 - 10	0,3 - 10



A1 SERIES 45cm Models BUILT-IN DISHWASHERS		A12 45cm	A1B 45cm	A13 45cm	A1C 45cm	A14 45cm	A1D 45cm	A15 45cm	A1E 45cm
<b>Dimensions</b>									
<b>Height (cm)</b>	Freestanding	85,0	85,0	85,0	85,0	85,0	85,0	85,0	85,0
	Semi-Integrated	-	-	-	-	-	-	-	-
	Fully Integrated	-	-	-	-	-	-	-	-
<b>Width (cm)</b>		44,8	44,8	44,8	44,8	44,8	44,8	44,8	44,8
<b>Depth (cm)</b>	Freestanding	59,8	59,8	59,8	59,8	59,8	59,8	59,8	59,8
	Semi-Integrated	-	-	-	-	-	-	-	-
	Fully Integrated	-	-	-	-	-	-	-	-
<b>Height adjustment (+cm)</b>	Freestanding	2	2	2	2	2	2	2	2
	Semi-Integrated	-	-	-	-	-	-	-	-
	Fully Integrated	-	-	-	-	-	-	-	-
<b>Adjustable Plinth for undertable usage (mm) Undertable</b>		(o) (80 or/ and 130)	(o) (80 or/ and 130)	(o) (80 or/ and 130)	(o) (80 or/ and 130)	(o) (80 or/ and 130)	(o) (80 or/ and 130)	(o) (80 or/ and 130)	(o) (80 or/ and 130)
<b>Possible adjustment of the plinth Undertable (horizontal / vertical) (mm / mm)</b>		0-100 / 0-50	0-100 / 0-50	0-100 / 0-50	0-100 / 0-50	0-100 / 0-50	0-100 / 0-50	0-100 / 0-50	0-100 / 0-50
<b>Height without worktop (cm) Undertable</b>		82,0	82,0	82,0	82,0	82,0	82,0	82,0	82,0
<b>Decorative panel height (max) (cm) Semi-Integrated</b>		-	-	-	-	-	-	-	-
<b>Plinth height (min) (cm) Semi-Integrated</b>		-	-	-	-	-	-	-	-
<b>Plinth depth (cm) Semi-Integrated</b>		-	-	-	-	-	-	-	-
<b>Packed dimensions (Width x Depth x Height) (cm)</b>	Freestanding	49.4 x 66.1 x 89.1	49.4 x 66.1 x 89.1	49.4 x 66.1 x 89.1	49.4 x 66.1 x 89.1	49.4 x 66.1 x 89.1	49.4 x 66.1 x 89.1	49.4 x 66.1 x 89.1	49.4 x 66.1 x 89.1
	Semi-Integrated	-	-	-	-	-	-	-	-
	Fully Integrated	-	-	-	-	-	-	-	-
<b>Stacking quantity (pcs)</b>	Freestanding	6	6	6	6	6	6	6	6
	Semi-Integrated	-	-	-	-	-	-	-	-
	Fully Integrated	-	-	-	-	-	-	-	-
<b>Gross/Net weight (kg)(3)</b>	Freestanding	42 /40	42 /40	42 /40	42 /40	42 /40	42 /40	42 /40	42 /40
	Semi-Integrated	-	-	-	-	-	-	-	-
	Fully Integrated	-	-	-	-	-	-	-	-
<b>Container loading (40"HC/ 40"/ 20")</b>		216 or 251 /144 /72	216 or 251 /144 /72	216 or 251 /144 /72	216 or 251 /144 /72	216 or 251 /144 /72	216 or 251 /144 /72	216 or 251 /144 /72	216 or 251 /144 /72

Notes

(o) : Optional

(\*) : See roadmap for availability

(1) : Turbo Fan feature & Aquazone or Electrical Diverter system are default for 3rd basket models.

(2) : Based on the tests performed with Eco programme in accordance with European Household Dishwasher Performance Standards

(3) : Gross/Net Weights are shown as reference in the table. It should be calculated based on the final product features created from this general spect table.

A2 SERIES 45cm Models BUILT-IN DISHWASHERS		A21 45cm	A22 45cm	A23 45cm	A24 45cm
<b>General Characteristics</b>					
<b>Number of place settings (PS)</b>	10 PS (2 baskets)	Default	Default	Default	Default
	10 PS (2 baskets + 3rd rack)	(o) with Turbo fan	(o) with Turbo fan	(o) with Turbo fan	(o)
	11 PS (2 baskets + 3rd rack)	-	-	-	(o)
<b>Number of programmes</b>		6	7	8+	8+
<b>Temperatures (°C)</b>		40-50-65	40-50-60-65	40-50-60-65	Auto-30-40-50-60-65-70
<b>Control type</b>	Default	Button Control	Button Control	Button Control	Button Control
	Option	-	-	-	-
<b>Hidden heating element</b>		Yes	Yes	Yes	Yes
<b>Filter type</b>	Metal	Default	Default	Default	Default
	Plastic	-	-	-	-
<b>Tub material</b>		Stainless Steel	Stainless Steel	Stainless Steel	Stainless Steel
<b>Turbidity sensor (Smart Wash)</b>		(o)	(o)	Yes	Yes
<b>Drying system</b>	Mini Active	Default	Default	Default	-
	Super Active	(o)	(o)	(o)	-
	Turbo	(o)	(o)	(o)	Default
<b>Electrical Diverter system</b>		Yes	Yes	Yes	Yes
<b>Overflow &amp; leakage protection</b>		Yes	Yes	Yes	Yes
<b>Heater protection</b>		Yes	Yes	Yes	Yes
<b>Circulation pump</b>	Asynchronous	Yes	Yes	Yes	-
	BLDC	-	-	-	Yes
<b>Ion Tech*</b>		(o)	(o)	(o)	(o)
<b>InfoLED</b>	1,0	-	-	-	-
	2.0 (Floor Indicator)	-	-	-	-
<b>Interior light</b>	one spot	(o)	(o)	(o)	(o)
	four spot *	(o)	(o)	(o)	(o)
<b>Available Aesthetics</b>	Freestanding	Angel	Angel	Angel	Angel
	Semi-Integrated	-	-	-	-
	Fully Integrated	-	-	-	-
<b>Appliance Color Options</b>		Black, Dark Gray, Dark Inox, Dark Silver, Inox, White	Black, Dark Gray, Dark Inox, Dark Silver, Inox, White	Black, Dark Gray, Dark Inox, Dark Silver, Inox, White	Black, Dark Gray, Dark Inox, Dark Silver, Inox, White
<b>Programmes</b>					
<b>Prewash</b>		Yes	Yes	Yes	-
<b>Mini 14' (Jet Wash)</b>		-	-	-	Yes
<b>Quick 30' 40°C</b>		Yes	Yes	Yes	Yes
<b>Eco (Standard Programme)</b>		Yes	Yes	Yes	Yes
<b>Super 50' 65°C (Quick Clean)</b>		Yes	Yes	Yes	Yes
<b>Super 55' 60°C</b>		-	-	-	-
<b>Delicate 40°C</b>		Yes	Yes	-	-
<b>Daily 60°C / Hybrid Wash 60°C</b>		-	Yes	Yes	-
<b>Dual Pro Wash 60°C</b>		-	-	-	Yes
<b>Intensive 65°C</b>		Yes	Yes	-	-
<b>Auto*</b>		(o)	(o)	-	-
<b>Auto Delicate 30°C - 50°C</b>		-	-	Yes	Yes
<b>Auto Normal 50°C - 60°C / Auto Flex 50°C - 60°C</b>		-	-	Yes	Yes
<b>Auto Intensive 60°C - 70°C</b>		-	-	Yes	Yes
<b>User Interface</b>					
<b>Start/Pause button</b>		Yes	Yes	Yes	Yes
<b>DISPLAY TYPE (delay start, remaining time)</b>		Mini or Large: LED	Mini or Large: LED	Mini or Large: LED	Mini or Large: LED
<b>Display Color</b>	Default	Red	Red	Red	Red
	Option	White	White	White	White
<b>Prewash button</b>		-	-	-	-
<b>Programme selection button</b>		Yes	Yes	Yes	Yes
<b>Delay timer option</b>	3hr,6hr,9hr	-	-	-	-
	1-2-3-...-19hr	-	-	-	-
	1-2-3-...-24hr	Yes	Yes	Yes	Yes
<b>Eco Wash - Half load option</b>	1 mode	-	-	-	-
	3 modes	Yes	Yes	Yes	Yes
<b>Tablet option</b>		Yes	Yes	Yes	Yes
<b>Extra Hygiene option</b>		Yes	Yes	Yes	Yes
<b>Extra Rinse option</b>		Yes	Yes	Yes	-
<b>Extra Drying option</b>		Yes	Yes	Yes	-
<b>Rinse-aid indicator</b>		Yes	Yes	Yes	Yes

A2 SERIES 45cm Models BUILT-IN DISHWASHERS		A21 45cm	A22 45cm	A23 45cm	A24 45cm
<b>User Interface</b>					
Salt indicator		Yes	Yes	Yes	Yes
Washing cycle indicators		Yes	Yes	Yes	Yes
End of cycle indicator		Yes	Yes	Yes	Yes
Child Lock		Yes	Yes	Yes	Yes
Buzzer		(o)	(o)	(o)	Yes
<b>Baskets &amp; Accessories</b>					
3rd basket (EasyTray) (1)	10 PS	(o)	(o)	(o)	(o)
Upper basket type		Peg	Peg	Peg	Peg
Adjustable upper basket [empty/ loaded 2 level / loaded 3 level*]		(o)	(o)	(o)	(o)
Number of mug shelves		4 (with 2 baskets)/ 2 (with 3rd basket)	4 (with 2 baskets)/ 2 (with 3rd basket)	4 (with 2 baskets)/ 2 (with 3rd basket)	4 (with 2 baskets)/ 2 (with 3rd basket)
Adjustable mug shelves		-	-	-	-
Mug shelves with soft touch rubber		(o)	(o)	(o)	(o)
Foldable racks on upper basket		(o)	(o)	(o)	(o)
Foldable racks on lower basket		(o)	(o)	(o)	(o)
Upper basket handle type [No / Plastic / Metal]		(o)	(o)	(o)	(o)
Lower basket handle type [No / Plastic / Metal]		(o)	(o)	(o)	(o)
Removable cutlery basket (Universal)		(Yes) with 2 baskets/ (o) with 3rd basket	(Yes) with 2 baskets/ (o) with 3rd basket	(Yes) with 2 baskets/ (o) with 3rd basket	(Yes) with 2 baskets/ (o) with 3rd basket
Wine glass holder on lower basket		(o) with foldable racks	(o) with foldable racks	(o) with foldable racks	(o) with foldable racks
Top nozzle	fixed type with 2 baskets	Default with 2 baskets	Default with 2 baskets	Default with 2 baskets	Default with 2 baskets
	rotating type	Default with 3rd basket	Default with 3rd basket	Default with 3rd basket	Default with 3rd basket
Aquastop external hose		(o)	(o)	(o)	(o)
Antibacterial filter		(o)	(o)	(o)	(o)
<b>Technical Data (2)</b>					
Sound level (dB(A) re 1 pW)	10 PS	57 / 54 / 52 / 49 / 47 / 45	57 / 54 / 52 / 49 / 47 / 45	57 / 54 / 52 / 49 / 47 / 45	44
Energy efficiency class		A++	A++	A++	A+++
Energy efficiency index	10 PS	55,8	55,8	55,8	49,7
Cleaning efficiency class		A	A	A	A
Cleaning efficiency index		1,13	1,13	1,13	1,13
Drying efficiency class		A	A	A	A
Drying efficiency index		1,09	1,09	1,09	1,09
Standard programme water consumption (lt / cycle)	Default	9,0	9,0	9,0	9,0
	with Aquazone	-	-	-	-
Annual water consumption (lt / year)	Default	2520	2520	2520	2520
	with Aquazone	-	-	-	-
Duration of the standard programme (min)	Default	198	198	198	185
	with Aquazone	-	-	-	-
Standard programme energy consumption (kWh / cycle)	10 PS	0,732	0,732	0,732	0,650
Annual energy consumption (kWh / year)	10 PS	211	211	211	188
Off mode power consumption (W)		0,50	0,50	0,50	0,50
Left-on mode power consumption (W)		1,00	1,00	1,00	1,00
Network standby mode power consumption (W)		N/A	N/A	N/A	N/A
Duration of left-on mode (min)		15	15	15	15
Power rating (W) / Heating element (W)		1900 / 1800	1900 / 1800	1900 / 1800	1900 / 1800
Plug Type		EU / UK / Swiss / Italy / Israel / AU/ NZ / China / Argentina / S.Africa	EU / UK / Swiss / Italy / Israel / AU/ NZ / China / Argentina / S.Africa	EU / UK / Swiss / Italy / Israel / AU/ NZ / China / Argentina / S.Africa	EU / UK / Swiss / Italy / Israel / AU/ NZ / China / Argentina / S.Africa
Power cord length (cm)		165	165	165	165
Water inlet hose length (cm)	Default	147	147	147	147
	with Aquastop ext. hose	170	170	170	170
Water outlet hose length (cm)		200	200	200	200
Voltage (V) / Frequency (Hz) / Fuse Rating (A)		220-240 / 50 / 10	220-240 / 50 / 10	220-240 / 50 / 10	220-240 / 50 / 10
Water pressure range (bar)		0,3 - 10	0,3 - 10	0,3 - 10	0,3 - 10

A2 SERIES 45cm Models BUILT-IN DISHWASHERS		A21 45cm	A22 45cm	A23 45cm	A24 45cm
<b>Dimensions</b>					
<b>Height (cm)</b>	Freestanding	85,0	85,0	85,0	85,0
	Semi-Integrated	-	-	-	-
	Fully Integrated	-	-	-	-
<b>Width (cm)</b>		44,8	44,8	44,8	44,8
<b>Depth (cm)</b>	Freestanding	59,8	59,8	59,8	59,8
	Semi-Integrated	-	-	-	-
	Fully Integrated	-	-	-	-
<b>Height adjustment (+cm)</b>	Freestanding	2	2	2	2
	Semi-Integrated	-	-	-	-
	Fully Integrated	-	-	-	-
<b>Adjustable Plinth for undertable usage (mm) Undertable</b>		(o) (80 or/and 130)	(o) (80 or/and 130)	(o) (80 or/and 130)	(o) (80 or/and 130)
<b>Possible adjustment of the plinth Undertable (horizontal / vertical) (mm / mm)</b>		0-100 / 0-50	0-100 / 0-50	0-100 / 0-50	0-100 / 0-50
<b>Height without worktop (cm) Undertable</b>		82,0	82,0	82,0	82,0
<b>Packed dimensions (Width x Depth x Height) (cm)</b>	Freestanding	49.4 x 66.1 x 89.1	49.4 x 66.1 x 89.1	49.4 x 66.1 x 89.1	49.4 x 66.1 x 89.1
	Semi-Integrated	-	-	-	-
	Fully Integrated	-	-	-	-
<b>Stacking quantity (pcs)</b>	Freestanding	6	6	6	6
	Semi-Integrated	-	-	-	-
	Fully Integrated	-	-	-	-
<b>Gross/Net weight (kg)(3)</b>	Freestanding	42 /40	42 /40	42 /40	42 /40
	Semi-Integrated	-	-	-	-
	Fully Integrated	-	-	-	-
<b>Container loading (40"HC/ 40" / 20")</b>		216 or 251 /144 /72	216 or 251 /144 /72	216 or 251 /144 /72	216 or 251 /144 /72

Notes

(o) : Optional

(\*) : See roadmap for availability

(1) : Turbo Fan feature & Aquazone or Electrical Diverter system are default for 3rd basket models.

(2) : Based on the tests performed with Eco programme in accordance with European Household Dishwasher Performance Standards

(3) : Gross/Net Weights are shown as reference in the table. It should be calculated based on the final product features created from this general spect table.



A3 SERIES 45cm Models BUILT-IN DISHWASHERS		A31 45cm	A32 45cm	A33 45cm	A34 45cm
<b>General Characteristics</b>					
<b>Number of place settings (PS)</b>	10 PS (2 baskets)	Default	Default	Default	Default
	10 PS (2 baskets + 3rd rack)	(o) with Turbo fan	(o) with Turbo fan	(o)	(o)
	11 PS (2 baskets + 3rd rack)	-	-	(o)	(o)
<b>Number of programmes</b>		6+	8+	6+	8+
<b>Temperatures (°C)</b>		40-50-65	40-50-60-65	Auto-30-40-50-60-65-70	Auto-30-40-50-60-65-70
<b>Control type</b>	Default	Button Control	Button Control	Button Control	Button Control
	Option	Touch Control	Touch Control	Touch Control	Touch Control
<b>Hidden heating element</b>		Yes	Yes	Yes	Yes
<b>Filter type</b>	Metal	Default	Default	Default	Default
	Plastic	-	-	-	-
<b>Tub material</b>		Stainless Steel	Stainless Steel	Stainless Steel	Stainless Steel
<b>Turbidity sensor (Smart Wash)</b>		-	-	Yes	Yes
<b>Drying system</b>	Mini Active	Default	Default	-	-
	Super Active	(o)	(o)	-	-
	Turbo	(o)	(o)	Default	Default
<b>Electrical Diverter system</b>		Yes	Yes	Yes	Yes
<b>Overflow &amp; leakage protection</b>		Yes	Yes	Yes	Yes
<b>Heater protection</b>		Yes	Yes	Yes	Yes
<b>Circulation pump</b>	Asynchronous	Yes	Yes	-	-
	BLDC	-	-	Yes	Yes
<b>Auto Door</b>		-	-	Yes	Yes
<b>Ion Tech*</b>		(o)	(o)	(o)	(o)
<b>Interior light</b>	one spot	(o)	(o)	(o)	(o)
	four spot *	(o)	(o)	(o)	(o)
<b>Available Aesthetics</b>	Freestanding	Angel	Angel	Angel	Angel
	Semi-Integrated	-	-	-	-
	Fully Integrated	-	-	-	-
<b>Appliance Color Options</b>		Black, Dark Gray, Dark Inox, Dark Silver, Inox, White	Black, Dark Gray, Dark Inox, Dark Silver, Inox, White	Black, Dark Gray, Dark Inox, Dark Silver, Inox, White	Black, Dark Gray, Dark Inox, Dark Silver, Inox, White
<b>Programmes</b>					
<b>Prewash</b>		Yes	Yes	-	-
<b>Mini 14' (Jet Wash)</b>		Yes	Yes	Yes	Yes
<b>Quick 30' 40°C</b>		Yes	Yes	Yes	Yes
<b>Eco (Standard Programme)</b>		Yes	Yes	Yes	Yes
<b>Super 50' 65°C (Quick Clean)</b>		Yes	Yes	Yes	Yes
<b>Dual Pro Wash 60°C</b>		-	-	Yes	Yes
<b>Auto Delicate 30°C - 50°C</b>		-	Yes	-	Yes
<b>Auto Normal 50°C - 60°C / Auto Flex 50°C - 60°C</b>		-	Yes	-	Yes
<b>Auto Intensive 60°C - 70°C</b>		Yes	Yes	Yes	Yes
<b>User Interface</b>					
<b>Start/Pause button</b>		Yes	Yes	Yes	Yes
<b>DISPLAY TYPE (delay start, remaining time)</b>		Large: Icon LED	Large: Icon LED	Large: Icon LED	Large: Icon LED
<b>Display Color</b>	Default	Red	Red	Red	Red
	Option	White	White	White	White
<b>Programme selection button</b>		Yes	Yes	Yes	Yes
<b>Delay timer option</b>	3hr,6hr,9hr	-	-	-	-
	1-2-3-...-19hr	-	-	-	-
	1-2-3-...-24hr	Yes	Yes	Yes	Yes
<b>Eco Wash - Half load option</b>	1 mode	-	-	-	-
	3 modes	Yes	Yes	Yes	Yes
<b>Tablet option</b>		Yes	Yes	Yes	Yes
<b>Extra Hygiene option</b>		Yes	Yes	Yes	Yes
<b>Extra Rinse option</b>		Yes	Yes	-	-
<b>Extra Drying option</b>		Yes	Yes	-	-
<b>Extra Silent option (Silent Wash)</b>		-	-	Yes	Yes
<b>Extra Fast option</b>		-	-	Yes	Yes
<b>Energy Save option</b>		-	-	Yes	Yes
<b>Rinse-aid indicator</b>		Yes	Yes	Yes	Yes
<b>Salt indicator</b>		Yes	Yes	Yes	Yes

A3 SERIES 45cm Models BUILT-IN DISHWASHERS		A31 45cm	A32 45cm	A33 45cm	A34 45cm
<b>User Interface</b>					
Washing cycle indicators		Yes	Yes	Yes	Yes
End of cycle indicator		Yes	Yes	Yes	Yes
Child Lock		Yes	Yes	Yes	Yes
Buzzer		Yes (Touch Control) / (o) Button Control	Yes (Touch Control) / (o) Button Control	Yes	Yes
<b>Baskets &amp; Accessories</b>					
3rd basket (EasyTray) (1)	10 PS	(o)	(o)	(o)	(o)
Upper basket type		Peg	Peg	Peg	Peg
Adjustable upper basket [empty/ loaded 2 level / loaded 3 level*]		(o)	(o)	(o)	(o)
Number of mug shelves		4 (with 2 baskets)/ 2 (with 3rd basket)	4 (with 2 baskets)/ 2 (with 3rd basket)	4 (with 2 baskets)/ 2 (with 3rd basket)	4 (with 2 baskets)/ 2 (with 3rd basket)
Adjustable mug shelves		-	-	-	-
Mug shelves with soft touch rubber		(o)	(o)	(o)	(o)
Foldable racks on upper basket		(o)	(o)	(o)	(o)
Foldable racks on lower basket		(o)	(o)	(o)	(o)
Upper basket handle type [No / Plastic / Metal]		(o)	(o)	(o)	(o)
Lower basket handle type [No / Plastic / Metal]		(o)	(o)	(o)	(o)
Removable cutlery basket (Single piece)		-	-	-	-
Removable cutlery basket (Universal)		(Yes) with 2 baskets/ (o) with 3rd basket	(Yes) with 2 baskets/ (o) with 3rd basket	(Yes) with 2 baskets/ (o) with 3rd basket	(Yes) with 2 baskets/ (o) with 3rd basket
Wine glass holder on lower basket		(o) with foldable racks	(o) with foldable racks	(o) with foldable racks	(o) with foldable racks
Top nozzle	fixed type with 2 baskets	Default with 2 baskets	Default with 2 baskets	Default with 2 baskets	Default with 2 baskets
	rotating type	Default with 3rd basket	Default with 3rd basket	Default with 3rd basket	Default with 3rd basket
AquaStop external hose		(o)	(o)	(o)	(o)
Antibacterial filter		(o)	(o)	(o)	(o)
Anti-siphon system		-	-	-	-
<b>Technical Data (2)</b>					
Sound level (dB(A) re 1 pW)	10 PS	57 / 54 / 52 / 49 / 47 / 45	57 / 54 / 52 / 49 / 47 / 45	44	44
Energy efficiency class		A++	A++	A+++	A+++
Energy efficiency index	10 PS	55,8	55,8	49,7	49,7
Cleaning efficiency class		A	A	A	A
Cleaning efficiency index		1,13	1,13	1,13	1,13
Drying efficiency class		A	A	A	A
Drying efficiency index		1,09	1,09	1,09	1,09
Standard programme water consumption (lt / cycle)	Default	9,0	9,0	9,0	9,0
	with Aquazone	-	-	-	-
Annual water consumption (lt / year)	Default	2520	2520	2520	2520
	with Aquazone	-	-	-	-
Duration of the standard programme (min)	Default	198	198	185	185
	with Aquazone	-	-	-	-
Standard programme energy consumption (kWh / cycle)		10 PS	0,732	0,732	0,650
Annual energy consumption (kWh/ year)		10 PS	211	211	188
Off mode power consumption (W)		0,50	0,50	0,50	0,50
Left-on mode power consumption (W)		1,00	1,00	1,00	1,00
Network standby mode power consumption (W)		N/A	N/A	N/A	N/A
Duration of left-on mode (min)		15	15	15	15
Power rating (W) / Heating element (W)		1900 / 1800	1900 / 1800	1900 / 1800	1900 / 1800
Plug Type		EU / UK / Swiss / Italy / Israel / AU/ NZ / China / Argentina / S.Africa	EU / UK / Swiss / Italy / Israel / AU/ NZ / China / Argentina / S.Africa	EU / UK / Swiss / Italy / Israel / AU/ NZ / China / Argentina / S.Africa	EU / UK / Swiss / Italy / Israel / AU/ NZ / China / Argentina / S.Africa
Power cord length (cm)		165	165	165	165
Water inlet hose length (cm)	Default	147	147	147	147
	with AquaStop ext. hose	170	170	170	170
Water outlet hose length (cm)		200	200	200	200
Voltage (V) / Frequency (Hz) / Fuse Rating (A)		220-240 / 50 / 10	220-240 / 50 / 10	220-240 / 50 / 10	220-240 / 50 / 10
Water pressure range (bar)		0,3 - 10	0,3 - 10	0,3 - 10	0,3 - 10

A3 SERIES 45cm Models BUILT-IN DISHWASHERS		A31 45cm	A32 45cm	A33 45cm	A34 45cm
<b>Dimensions</b>					
<b>Height (cm)</b>	Freestanding	85,0	85,0	85,0	85,0
	Semi-Integrated	-	-	-	-
	Fully Integrated	-	-	-	-
<b>Width (cm)</b>		44,8	44,8	44,8	44,8
<b>Depth (cm)</b>	Freestanding	59,8	59,8	59,8	59,8
	Semi-Integrated	-	-	-	-
	Fully Integrated	-	-	-	-
<b>Height adjustment (+cm)</b>	Freestanding	2	2	2	2
	Semi-Integrated	-	-	-	-
	Fully Integrated	-	-	-	-
<b>Adjustable Plinth for undertable usage (mm) Undertable</b>		(o) (80 or/and 130)	(o) (80 or/and 130)	(o) (80 or/and 130)	(o) (80 or/and 130)
<b>Possible adjustment of the plinth Undertable (horizontal / vertical) (mm / mm)</b>		0-100 / 0-50	0-100 / 0-50	0-100 / 0-50	0-100 / 0-50
<b>Height without worktop (cm) Undertable</b>		82,0	82,0	82,0	82,0
<b>Plinth depth (cm) Semi-Integrated</b>		-	-	-	-
<b>Packed dimensions (Width x Depth x Height) (cm)</b>	Freestanding	49,4 x 66,1 x 89,1	49,4 x 66,1 x 89,1	49,4 x 66,1 x 89,1	49,4 x 66,1 x 89,1
	Semi-Integrated	-	-	-	-
	Fully Integrated	-	-	-	-
<b>Stacking quantity (pcs)</b>	Freestanding	6	6	6	6
	Semi-Integrated	-	-	-	-
	Fully Integrated	-	-	-	-
<b>Gross/Net weight (kg)(3)</b>	Freestanding	42 /40	42 /40	42 /40	42 /40
	Semi-Integrated	-	-	-	-
	Fully Integrated	-	-	-	-
<b>Container loading (40"HC/ 40"/ 20")</b>		216 or 251 /144 /72	216 or 251 /144 /72	216 or 251 /144 /72	216 or 251 /144 /72

Notes

(o) : Optional

(\*) : See roadmap for availability

(1) : Turbo Fan feature & Aquazone or Electrical Diverter system are default for 3rd basket models.

(2) : Based on the tests performed with Eco programme in accordance with European Household Dishwasher Performance Standards

(3) : Gross/Net Weights are shown as reference in the table. It should be calculated based on the final product features created from this general spec table.

A4 SERIES 45cm Models BUILT-IN or SEMI-INTEGRATED		A41 45cm	A42 45cm	A43 45cm	A44 45cm
<b>General Characteristics</b>					
<b>Number of place settings (PS)</b>	10 PS (2 baskets)	Default	Default	Default	Default
	10 PS (2 baskets + 3rd rack)	(o)	(o)	(o)	(o)
	11 PS (2 baskets + 3rd rack)	-	-	(o)	(o)
<b>Number of programmes</b>		6+	7+	10+	10+
<b>Temperatures (°C)</b>		Auto-30-40-50-60-65-70	Auto-30-40-50-60-65-70	Auto-30-40-50-60-65-70	Auto-30-40-50-60-65-70
<b>Control type</b>	Default	Touch Control	Touch Control	Touch Control	Touch Control
	Option	-	-	-	-
<b>Hidden heating element</b>		Yes	Yes	Yes	Yes
<b>Filter type</b>	Metal	Default	Default	Default	Default
	Plastic	-	-	-	-
<b>Tub material</b>		Stainless Steel	Stainless Steel	Stainless Steel	Stainless Steel
<b>Turbidity sensor (Smart Wash)</b>		Yes	Yes	Yes	Yes
<b>Drying system</b>	Mini Active	-	-	-	-
	Super Active	-	-	-	-
	Turbo	Default	Default	Default	Default
<b>Electrical Diverter system</b>		Yes	Yes	Yes	Yes
<b>Overflow &amp; leakage protection</b>		Yes	Yes	Yes	Yes
<b>Heater protection</b>		Yes	Yes	Yes	Yes
<b>Circulation pump</b>	Asynchronous	-	-	-	-
	BLDC	Yes	Yes	Yes	Yes
<b>Auto Door</b>		-	-	Yes	Yes
<b>Ion Tech*</b>		(o)	(o)	(o)	(o)
<b>InfoLED</b>	1,0	-	-	-	-
	2,0 (Floor Indicator)	-	-	-	-
<b>Interior light</b>	one spot	(o)	(o)	(o)	(o)
	four spot *	(o)	(o)	(o)	(o)
<b>Available Aesthetics</b>	Freestanding	Angel	Angel	Angel	Angel
	Semi-Integrated	-	-	-	-
	Fully Integrated	-	-	-	-
<b>Appliance Color Options</b>		Black, Dark Gray, Dark Inox, Dark Silver, Inox, White	Black, Dark Gray, Dark Inox, Dark Silver, Inox, White	Black, Dark Gray, Dark Inox, Dark Silver, Inox, White	Black, Dark Gray, Dark Inox, Dark Silver, Inox, White
<b>Programmes</b>					
<b>Prewash</b>		Yes	Yes	Yes	Yes
<b>Mini 14' (Jet Wash)</b>		-	Yes	Yes	Yes
<b>Quick 30' 40°C</b>		Yes	Yes	Yes	Yes
<b>Eco (Standard Programme)</b>		Yes	Yes	Yes	Yes
<b>Super 50' 65°C (Quick Clean)</b>		Yes	Yes	Yes	Yes
<b>Daily 60°C / Hybrid Wash 60°C</b>		-	-	Yes	Yes
<b>Dual Pro Wash 60°C</b>		Yes	Yes	Yes	Yes
<b>Auto Delicate 30°C - 50°C</b>		-	-	Yes	Yes
<b>Auto Normal 50°C - 60°C / Auto Flex 50°C - 60°C</b>		-	-	Yes	Yes
<b>Auto Intensive 60°C - 70°C</b>		Yes	Yes	Yes	Yes
<b>User Interface</b>					
<b>Start/Pause button</b>		Yes	Yes	Yes	Yes
<b>DISPLAY TYPE (delay start, remaining time)</b>		Large: Full Touch + Icon LED	Large: Full Touch + Icon LED	Large: Full Touch + Icon LED	Large: Full Touch + Icon LED
<b>Display Color</b>	Default	White	White	White	White
	Option	-	-	-	-
<b>Programme selection button</b>		Yes	Yes	Yes	Yes
<b>Delay timer option</b>	3hr,6hr,9hr	-	-	-	-
	1-2-3-...-19hr	-	-	-	-
	1-2-3-...-24hr	Yes	Yes	Yes	Yes
<b>Eco Wash - Half load option</b>	1 mode	-	-	-	-
	3 modes	Yes	Yes	Yes	Yes
<b>Tablet option</b>		Yes	Yes	Yes	Yes
<b>Extra Hygiene option</b>		Yes	Yes	Yes	Yes
<b>Extra Rinse option</b>		-	-	-	-
<b>Extra Drying option</b>		-	Yes	Yes	Yes
<b>Extra Silent option (Silent Wash)</b>		-	Yes	Yes	Yes
<b>Extra Fast option</b>		Yes	Yes	Yes	Yes
<b>Energy Save option</b>		-	-	-	Yes
<b>Rinse-aid indicator</b>		Yes	Yes	Yes	Yes



A4 SERIES 45cm Models BUILT-IN or SEMI-INTEGRATED		A41 45cm	A42 45cm	A43 45cm	A44 45cm
<b>User Interface</b>					
Salt indicator		Yes	Yes	Yes	Yes
Washing cycle indicators		Yes	Yes	Yes	Yes
End of cycle indicator		Yes	Yes	Yes	Yes
Child Lock		Yes	Yes	Yes	Yes
Buzzer		Yes	Yes	Yes	Yes
<b>Baskets &amp; Accessories</b>					
3rd basket (EasyTray) (1)	10 PS	(o)	(o)	(o)	(o)
Upper basket type		Peg	Peg	Peg	Peg
Adjustable upper basket [empty/ loaded 2 level / loaded 3 level*]		(o)	(o)	(o)	(o)
Number of mug shelves		4 (with 2 baskets)/ 2 (with 3rd basket)	4 (with 2 baskets)/ 2 (with 3rd basket)	4 (with 2 baskets)/ 2 (with 3rd basket)	4 (with 2 baskets)/ 2 (with 3rd basket)
Adjustable mug shelves		-	-	-	-
Mug shelves with soft touch rubber		(o)	(o)	(o)	(o)
Foldable racks on upper basket		(o)	(o)	(o)	(o)
Foldable racks on lower basket		(o)	(o)	(o)	(o)
Upper basket handle type [No / Plastic / Metal]		(o)	(o)	(o)	(o)
Lower basket handle type [No / Plastic / Metal]		(o)	(o)	(o)	(o)
Removable cutlery basket (Single piece)		-	-	-	-
Removable cutlery basket (Universal)		(Yes) with 2 baskets/ (o) with 3rd basket	(Yes) with 2 baskets/ (o) with 3rd basket	(Yes) with 2 baskets/ (o) with 3rd basket	(Yes) with 2 baskets/ (o) with 3rd basket
Wine glass holder on lower basket		(o) with foldable racks	(o) with foldable racks	(o) with foldable racks	(o) with foldable racks
Top nozzle	fixed type with 2 baskets	Default with 2 baskets	Default with 2 baskets	Default with 2 baskets	Default with 2 baskets
	rotating type	Default with 3rd basket	Default with 3rd basket	Default with 3rd basket	Default with 3rd basket
Aquastop external hose		(o)	(o)	(o)	(o)
Antibacterial filter		(o)	(o)	(o)	(o)
<b>Technical Data (2)</b>					
Sound level (dB(A) re 1 pW)	10 PS	44	44	44	44
Energy efficiency class		A++	A++	A+++	A+++
Energy efficiency index	10 PS	55,8	55,8	49,7	49,7
Cleaning efficiency class		A	A	A	A
Cleaning efficiency index		1,13	1,13	1,13	1,13
Drying efficiency class		A	A	A	A
Drying efficiency index		1,09	1,09	1,09	1,09
Standard programme water consumption (lt / cycle)	Default	9,0	9,0	9,0	9,0
	with Aquazone	-	-	-	-
Annual water consumption (lt / year)	Default	2520	2520	2520	2520
	with Aquazone				
Duration of the standard programme (min)	Default	TBD	TBD	185	185
	with Aquazone	-	-	-	-
Standard programme energy consumption (kWh / cycle)	10 PS	0,732	0,732	0,650	0,650
Annual energy consumption (kWh/ year)	10 PS	211	211	188	188
Off mode power consumption (W)		0,50	0,50	0,50	0,50
Left-on mode power consumption (W)		1,00	1,00	1,00	1,00
Network standby mode power consumption (W)		N/A	N/A	N/A	N/A
Duration of left-on mode (min)		15	15	15	15
Power rating (W) / Heating element (W)		1900 / 1800	1900 / 1800	1900 / 1800	1900 / 1800
Plug Type		EU / UK / Swiss / Italy / Israel / AU / NZ / China / Argentina / S.Africa	EU / UK / Swiss / Italy / Israel / AU / NZ / China / Argentina / S.Africa	EU / UK / Swiss / Italy / Israel / AU / NZ / China / Argentina / S.Africa	EU / UK / Swiss / Italy / Israel / AU / NZ / China / Argentina / S.Africa
Power cord length (cm)		165	165	165	165
Water inlet hose length (cm)	Default	147	147	147	147
	with Aquastop ext. hose	170	170	170	170
Water outlet hose length (cm)		200	200	200	200
Voltage (V) / Frequency (Hz) / Fuse Rating (A)		220-240 / 50 / 10	220-240 / 50 / 10	220-240 / 50 / 10	220-240 / 50 / 10
Water pressure range (bar)		0,3 - 10	0,3 - 10	0,3 - 10	0,3 - 10

A4 SERIES 45cm Models BUILT-IN or SEMI-INTEGRATED		A41 45cm	A42 45cm	A43 45cm	A44 45cm
<b>Dimensions</b>					
<b>Height (cm)</b>	Freestanding	85,0	85,0	85,0	85,0
	Semi-Integrated	-	-	-	-
	Fully Integrated	-	-	-	-
<b>Width (cm)</b>		44,8	44,8	44,8	44,8
<b>Depth (cm)</b>	Freestanding	59,8	59,8	59,8	59,8
	Semi-Integrated	-	-	-	-
	Fully Integrated	-	-	-	-
<b>Height adjustment (+cm)</b>	Freestanding	2	2	2	2
	Semi-Integrated	-	-	-	-
	Fully Integrated	-	-	-	-
<b>Adjustable Plinth for undertable usage (mm) Undertable</b>		(o) (80 or/and 130)	(o) (80 or/and 130)	(o) (80 or/and 130)	(o) (80 or/and 130)
<b>Possible adjustment of the plinth Undertable (horizontal / vertical) (mm / mm)</b>		0-100 / 0-50	0-100 / 0-50	0-100 / 0-50	0-100 / 0-50
<b>Height without worktop (cm) Undertable</b>		82,0	82,0	82,0	82,0
<b>Packed dimensions (Width x Depth x Height) (cm)</b>	Freestanding	49.4 x 66.1 x 89.1	49.4 x 66.1 x 89.1	49.4 x 66.1 x 89.1	49.4 x 66.1 x 89.1
	Semi-Integrated	-	-	-	-
	Fully Integrated	-	-	-	-
<b>Stacking quantity (pcs)</b>	Freestanding	6	6	6	6
	Semi-Integrated	-	-	-	-
	Fully Integrated	-	-	-	-
<b>Gross/Net weight (kg)(3)</b>	Freestanding	42 /40	42 /40	42 /40	42 /40
	Semi-Integrated	-	-	-	-
	Fully Integrated	-	-	-	-
<b>Container loading (40"HC/ 40" / 20")</b>		216 or 251 /144 /72	216 or 251 /144 /72	216 or 251 /144 /72	216 or 251 /144 /72

Notes

(o) : Optional

(\*) : See roadmap for availability

(1) : Turbo Fan feature & Aquazone or Electrical Diverter system are default for 3rd basket models.

(2) : Based on the tests performed with Eco programme in accordance with European Household Dishwasher Performance Standards

(3) : Gross/Net Weights are shown as reference in the table. It should be calculated based on the final product features created from this general spect table.

X SERIES 45cm Models BUILT-IN DISHWASHERS		X11 45cm	X1A 45cm	X12 45cm	X1B 45cm	X13 45cm	X1C 45cm	X14 45cm	X1D 45cm	X15 45cm	X1E 45cm	X16 45cm	X1F 45cm
<b>General Characteristics</b>													
<b>Number of place settings (PS)</b>	10 PS (2 baskets)	Default	Default	Default	Default	Default	Default	Default	Default	Default	Default	Default	Default
	10 PS (2 baskets + 3rd rack)	-	-	-	-	-	-	-	-	-	-	-	-
<b>Number of programmes</b>		2	2	3	3	4	4	5	5	6	6	7	7
<b>Temperatures (°C)</b>		50-65	50-65	50-65	50-65	50-65	50-65	40-50-65-70	40-50-65-70	40-50-65-70	40-50-65-70	40-50-65-70	40-50-65-70
<b>Control type</b>	Default	Knob Control	Knob Control	Knob Control	Knob Control	Knob Control	Knob Control	Knob Control	Knob Control	Knob Control	Knob Control	Knob Control	Knob Control
	Option	-	-	-	-	-	-	-	-	-	-	-	-
<b>Hidden heating element</b>		Yes	Yes	Yes	Yes	Yes	Yes	Yes	Yes	Yes	Yes	Yes	Yes
<b>Filter type</b>	Metal	Default	Default	Default	Default	Default	Default	Default	Default	Default	Default	Default	Default
	Plastic	-	-	-	-	-	-	-	-	-	-	-	-
<b>Tub material</b>		Stainless Steel	Stainless Steel	Stainless Steel	Stainless Steel	Stainless Steel	Stainless Steel	Stainless Steel	Stainless Steel	Stainless Steel	Stainless Steel	Stainless Steel	Stainless Steel
<b>Turbidity sensor (Smart Wash)</b>		-	-	-	-	-	-	-	-	-	-	-	-
<b>Drying system</b>	Mini Active	Default	Default	Default	Default	Default	Default	Default	Default	Default	Default	Default	Default
	Super Active	(o)	(o)	(o)	(o)	(o)	(o)	(o)	(o)	(o)	(o)	(o)	(o)
	Turbo	-	-	-	-	-	-	-	-	-	-	-	-
<b>Electrical Diverter system</b>		-	-	-	-	-	-	-	-	-	-	-	-
<b>Overflow &amp; leakage protection</b>		Yes	Yes	Yes	Yes	Yes	Yes	Yes	Yes	Yes	Yes	Yes	Yes
<b>Heater protection</b>		Yes	Yes	Yes	Yes	Yes	Yes	Yes	Yes	Yes	Yes	Yes	Yes
<b>Circulation pump</b>	Asynchronous	Yes	Yes	Yes	Yes	Yes	Yes	Yes	Yes	Yes	Yes	Yes	Yes
	BLDC	-	-	-	-	-	-	-	-	-	-	-	-
<b>Aquazone</b>		(o)	(o)	(o)	(o)	(o)	(o)	(o)	(o)	(o)	(o)	(o)	(o)
<b>Available Aesthetics</b>	Freestanding	Iris C, Kliky, Lydia	Iris C, Kliky, Lydia	Iris C, Kliky, Lydia	Iris C, Kliky, Lydia	Iris C, Kliky, Lydia	Iris C, Kliky, Lydia	Iris C, Kliky, Lydia	Iris C, Kliky, Lydia	Iris C, Kliky, Lydia	Iris C, Kliky, Lydia	Iris C, Kliky, Lydia	Iris C, Kliky, Lydia
	Semi-Integrated	Kliky, Orchis	Kliky, Orchis	Kliky, Orchis	Kliky, Orchis	Kliky, Orchis	Kliky, Orchis	Kliky, Orchis	Kliky, Orchis	Kliky, Orchis	Kliky, Orchis	Kliky, Orchis	Kliky, Orchis
	Fully Integrated	-	-	-	-	-	-	-	-	-	-	-	-
<b>Appliance Color Options</b>		Black, Dark Gray, Dark Inox, Dark Silver, Inox, White	Black, Dark Gray, Dark Inox, Dark Silver, Inox, White	Black, Dark Gray, Dark Inox, Dark Silver, Inox, White	Black, Dark Gray, Dark Inox, Dark Silver, Inox, White	Black, Dark Gray, Dark Inox, Dark Silver, Inox, White	Black, Dark Gray, Dark Inox, Dark Silver, Inox, White	Black, Dark Gray, Dark Inox, Dark Silver, Inox, White	Black, Dark Gray, Dark Inox, Dark Silver, Inox, White	Black, Dark Gray, Dark Inox, Dark Silver, Inox, White	Black, Dark Gray, Dark Inox, Dark Silver, Inox, White	Black, Dark Gray, Dark Inox, Dark Silver, Inox, White	Black, Dark Gray, Dark Inox, Dark Silver, Inox, White
<b>Programmes</b>													
<b>Prewash</b>		-	-	-	-	Yes	Yes	-	-	Yes	Yes	Yes	Yes
<b>Quick 30' 40°C</b>		-	-	-	-	-	-	Yes	Yes	Yes	Yes	Yes	Yes
<b>Eco (Standard Programme)</b>		Yes	Yes	Yes	Yes	Yes	Yes	Yes	Yes	Yes	Yes	Yes	Yes
<b>Super 50' 65°C (Quick Clean)</b>		-	-	Yes	Yes	Yes	Yes	Yes	Yes	Yes	Yes	Yes	Yes
<b>Super 55' 60°C</b>		-	-	-	-	-	-	-	-	-	-	-	-
<b>Delicate 40°C</b>		-	-	-	-	-	-	-	-	-	-	Yes	Yes
<b>Hygiene 70°C</b>		-	-	-	-	-	-	Yes	Yes	Yes	Yes	Yes	Yes
<b>Intensive 65°C</b>		Yes	Yes	Yes	Yes	Yes	Yes	Yes	Yes	Yes	Yes	Yes	Yes
<b>User Interface</b>													
<b>Start/Pause button</b>		Yes	Yes	Yes	Yes	Yes	Yes	Yes	Yes	Yes	Yes	Yes	Yes
<b>DISPLAY TYPE (delay start, remaining time)</b>		-	LED	-	LED	-	LED	-	LED	-	LED	-	LED
<b>Display Color</b>	Default	-	Red	-	Red	-	Red	-	Red	-	Red	-	Red
	Option	-	-	-	-	-	-	-	-	-	-	-	-
<b>Prewash button</b>		-	-	-	-	-	-	-	-	-	-	-	-
<b>Programme selection button</b>		Knob	Knob	Knob	Knob	Knob	Knob	Knob	Knob	Knob	Knob	Knob	Knob
<b>Delay timer option</b>	3hr,6hr,9hr	Yes	-	Yes	-	Yes	-	Yes	-	Yes	-	Yes	-
	1-2-3-...-19hr	-	Yes	-	Yes	-	Yes	-	Yes	-	Yes	-	Yes
	1-2-3-...-24hr	-	-	-	-	-	-	-	-	-	-	-	-
<b>Eco Wash - Half load option</b>		1 mode	Yes	Yes	Yes	Yes	Yes	Yes	Yes	Yes	Yes	Yes	Yes
<b>Rinse-aid indicator</b>		Yes	Yes	Yes	Yes	Yes	Yes	Yes	Yes	Yes	Yes	Yes	Yes
<b>Salt indicator</b>		Yes	Yes	Yes	Yes	Yes	Yes	Yes	Yes	Yes	Yes	Yes	Yes
<b>Washing cycle indicators</b>		Yes	Yes	Yes	Yes	Yes	Yes	Yes	Yes	Yes	Yes	Yes	Yes
<b>End of cycle indicator</b>		Yes	Yes	Yes	Yes	Yes	Yes	Yes	Yes	Yes	Yes	Yes	Yes
<b>Child Lock</b>		-	Yes	-	Yes	-	Yes	-	Yes	-	Yes	-	Yes
<b>Buzzer</b>		-	-	-	-	-	-	-	-	-	-	-	-

X SERIES 45cm Models BUILT-IN DISHWASHERS		X11 45cm	X1A 45cm	X12 45cm	X1B 45cm	X13 45cm	X1C 45cm	X14 45cm	X1D 45cm	X15 45cm	X1E 45cm	X16 45cm	X1F 45cm
<b>Baskets &amp; Accessories</b>													
Upper basket type		Peg	Peg	Peg	Peg	Peg	Peg	Peg	Peg	Peg	Peg	Peg	Peg
Adjustable upper basket [empty/ loaded 2 level / loaded 3 level*]		(o)	(o)	(o)	(o)	(o)	(o)	(o)	(o)	(o)	(o)	(o)	(o)
Number of mug shelves		4 (std)	4 (std)	4 (std)	4 (std)	4 (std)	4 (std)	4 (std)	4 (std)	4 (std)	4 (std)	4 (std)	4 (std)
Adjustable mug shelves		-	-	-	-	-	-	-	-	-	-	-	-
Mug shelves with soft touch rubber		(o)	(o)	(o)	(o)	(o)	(o)	(o)	(o)	(o)	(o)	(o)	(o)
Foldable racks on upper basket		(o)	(o)	(o)	(o)	(o)	(o)	(o)	(o)	(o)	(o)	(o)	(o)
Foldable racks on lower basket		(o)	(o)	(o)	(o)	(o)	(o)	(o)	(o)	(o)	(o)	(o)	(o)
Upper basket handle type [No / Plastic / Metal]		(o)	(o)	(o)	(o)	(o)	(o)	(o)	(o)	(o)	(o)	(o)	(o)
Lower basket handle type [No / Plastic / Metal]		(o)	(o)	(o)	(o)	(o)	(o)	(o)	(o)	(o)	(o)	(o)	(o)
Removable cutlery basket (Single piece)		-	-	-	-	-	-	-	-	-	-	-	-
Removable cutlery basket (Universal)		Yes	Yes	Yes	Yes	Yes	Yes	Yes	Yes	Yes	Yes	Yes	Yes
Wine glass holder on lower basket		(o) with foldable racks	(o) with foldable racks	(o) with foldable racks	(o) with foldable racks	(o) with foldable racks	(o) with foldable racks	(o) with foldable racks	(o) with foldable racks	(o) with foldable racks	(o) with foldable racks	(o) with foldable racks	(o) with foldable racks
Top nozzle	fixed type with 2 baskets	Default	Default	Default	Default	Default	Default	Default	Default	Default	Default	Default	Default
	rotating type	-	-	-	-	-	-	-	-	-	-	-	-
Aquastop external hose		(o)	(o)	(o)	(o)	(o)	(o)	(o)	(o)	(o)	(o)	(o)	(o)
Antibacterial filter		(o)	(o)	(o)	(o)	(o)	(o)	(o)	(o)	(o)	(o)	(o)	(o)
<b>Technical Data (2)</b>													
Sound level (dB(A) re 1 pW)	10 PS	57 / 54 / 52 / 49 / 47 / 45	57 / 54 / 52 / 49 / 47 / 45	57 / 54 / 52 / 49 / 47 / 45	57 / 54 / 52 / 49 / 47 / 45	57 / 54 / 52 / 49 / 47 / 45	57 / 54 / 52 / 49 / 47 / 45	57 / 54 / 52 / 49 / 47 / 45	57 / 54 / 52 / 49 / 47 / 45	57 / 54 / 52 / 49 / 47 / 45	57 / 54 / 52 / 49 / 47 / 45	57 / 54 / 52 / 49 / 47 / 45	57 / 54 / 52 / 49 / 47 / 45
Energy efficiency class		A++	A++	A++	A++	A++	A++	A++	A++	A++	A++	A++	A++
Energy efficiency index	10 PS	55,8	55,8	55,8	55,8	55,8	55,8	55,8	55,8	55,8	55,8	55,8	55,8
Cleaning efficiency class		A	A	A	A	A	A	A	A	A	A	A	A
Cleaning efficiency index		1,13	1,13	1,13	1,13	1,13	1,13	1,13	1,13	1,13	1,13	1,13	1,13
Drying efficiency class		A	A	A	A	A	A	A	A	A	A	A	A
Drying efficiency index		1,09	1,09	1,09	1,09	1,09	1,09	1,09	1,09	1,09	1,09	1,09	1,09
Standard programme water consumption (lt / cycle)	Default	11,0	11,0	11,0	11,0	11,0	11,0	11,0	11,0	11,0	11,0	11,0	11,0
	with Aquazone	9,0	9,0	9,0	9,0	9,0	9,0	9,0	9,0	9,0	9,0	9,0	9,0
Annual water consumption (lt / year)	Default	3080	3080	3080	3080	3080	3080	3080	3080	3080	3080	3080	3080
	with Aquazone	2520	2520	2520	2520	2520	2520	2520	2520	2520	2520	2520	2520
Duration of the standard programme (min)	Default	198	198	198	198	198	198	198	198	198	198	198	198
	with Aquazone	222	222	222	222	222	222	222	222	222	222	222	222
Standard programme energy consumption (kWh / cycle)	10 PS	0,732	0,732	0,732	0,732	0,732	0,732	0,732	0,732	0,732	0,732	0,732	0,732
Annual energy consumption (kWh / year)	10 PS	211	211	211	211	211	211	211	211	211	211	211	211
Off mode power consumption (W)		0,50	0,50	0,50	0,50	0,50	0,50	0,50	0,50	0,50	0,50	0,50	0,50
Left-on mode power consumption (W)		1,00	1,00	1,00	1,00	1,00	1,00	1,00	1,00	1,00	1,00	1,00	1,00
Network standby mode power consumption (W)		N/A	N/A	N/A	N/A	N/A	N/A	N/A	N/A	N/A	N/A	N/A	N/A
Duration of left-on mode (min)		N/A	N/A	N/A	N/A	N/A	N/A	N/A	N/A	N/A	N/A	N/A	N/A
Power rating (W) / Heating element (W)		1900 / 1800	1900 / 1800	1900 / 1800	1900 / 1800	1900 / 1800	1900 / 1800	1900 / 1800	1900 / 1800	1900 / 1800	1900 / 1800	1900 / 1800	1900 / 1800
Plug Type		EU / UK / Swiss / Italy / Israel / AU/NZ / China / Argentina / S.Africa	EU / UK / Swiss / Italy / Israel / AU/NZ / China / Argentina / S.Africa	EU / UK / Swiss / Italy / Israel / AU/NZ / China / Argentina / S.Africa	EU / UK / Swiss / Italy / Israel / AU/NZ / China / Argentina / S.Africa	EU / UK / Swiss / Italy / Israel / AU/NZ / China / Argentina / S.Africa	EU / UK / Swiss / Italy / Israel / AU/NZ / China / Argentina / S.Africa	EU / UK / Swiss / Italy / Israel / AU/NZ / China / Argentina / S.Africa	EU / UK / Swiss / Italy / Israel / AU/NZ / China / Argentina / S.Africa	EU / UK / Swiss / Italy / Israel / AU/NZ / China / Argentina / S.Africa	EU / UK / Swiss / Italy / Israel / AU/NZ / China / Argentina / S.Africa	EU / UK / Swiss / Italy / Israel / AU/NZ / China / Argentina / S.Africa	EU / UK / Swiss / Italy / Israel / AU/NZ / China / Argentina / S.Africa
Power cord length (cm)		165	165	165	165	165	165	165	165	165	165	165	165
Water inlet hose length (cm)	Default	147	147	147	147	147	147	147	147	147	147	147	147
	with AquaStop ext. hose	170	170	170	170	170	170	170	170	170	170	170	170
Water outlet hose length (cm)		200	200	200	200	200	200	200	200	200	200	200	200
Voltage (V) / Frequency (Hz) / Fuse Rating (A)		220-240 / 50 / 10	220-240 / 50 / 10	220-240 / 50 / 10	220-240 / 50 / 10	220-240 / 50 / 10	220-240 / 50 / 10	220-240 / 50 / 10	220-240 / 50 / 10	220-240 / 50 / 10	220-240 / 50 / 10	220-240 / 50 / 10	220-240 / 50 / 10
Water pressure range (bar)		0,3 - 10	0,3 - 10	0,3 - 10	0,3 - 10	0,3 - 10	0,3 - 10	0,3 - 10	0,3 - 10	0,3 - 10	0,3 - 10	0,3 - 10	0,3 - 10



X SERIES 45cm Models BUILT-IN DISHWASHERS		X11 45cm	X1A 45cm	X12 45cm	X1B 45cm	X13 45cm	X1C 45cm	X14 45cm	X1D 45cm	X15 45cm	X1E 45cm	X16 45cm	X1F 45cm
<b>Dimensions</b>													
<b>Height (cm)</b>	Freestanding	85,0	85,0	85,0	85,0	85,0	85,0	85,0	85,0	85,0	85,0	85,0	85,0
	Semi-Integrated	82,0	82,0	82,0	82,0	82,0	82,0	82,0	82,0	82,0	82,0	82,0	82,0
	Fully Integrated	-	-	-	-	-	-	-	-	-	-	-	-
<b>Width (cm)</b>		44,8	44,8	44,8	44,8	44,8	44,8	44,8	44,8	44,8	44,8	44,8	44,8
<b>Depth (cm)</b>	Freestanding	59,8	59,8	59,8	59,8	59,8	59,8	59,8	59,8	59,8	59,8	59,8	59,8
	Semi-Integrated	57,0	57,0	57,0	57,0	57,0	57,0	57,0	57,0	57,0	57,0	57,0	57,0
	Fully Integrated	-	-	-	-	-	-	-	-	-	-	-	-
<b>Height adjustment (+cm)</b>	Freestanding	2	2	2	2	2	2	2	2	2	2	2	2
	Semi-Integrated	5	5	5	5	5	5	5	5	5	5	5	5
	Fully Integrated	-	-	-	-	-	-	-	-	-	-	-	-
<b>Adjustable Plinth for undertable usage (mm) Undertable</b>		(o) (80 or/ and 130)	(o) (80 or/ and 130)	(o) (80 or/ and 130)	(o) (80 or/ and 130)	(o) (80 or/ and 130)	(o) (80 or/ and 130)	(o) (80 or/ and 130)	(o) (80 or/ and 130)	(o) (80 or/ and 130)	(o) (80 or/ and 130)	(o) (80 or/ and 130)	(o) (80 or/ and 130)
<b>Possible adjustment of the plinth Undertable (horizontal / vertical) (mm / mm)</b>		0-100 / 0-50	0-100 / 0-50	0-100 / 0-50	0-100 / 0-50	0-100 / 0-50	0-100 / 0-50	0-100 / 0-50	0-100 / 0-50	0-100 / 0-50	0-100 / 0-50	0-100 / 0-50	0-100 / 0-50
<b>Height without worktop (cm) Undertable</b>		82,0	82,0	82,0	82,0	82,0	82,0	82,0	82,0	82,0	82,0	82,0	82,0
<b>Decorative panel height (max) (cm) Semi-Integrated</b>		59,7	59,7	59,7	59,7	59,7	59,7	59,7	59,7	59,7	59,7	59,7	59,7
<b>Plinth height (min) (cm) Semi-Integrated</b>		8	8	8	8	8	8	8	8	8	8	8	8
<b>Plinth depth (cm) Semi-Integrated</b>		3 - 8	3 - 8	3 - 8	3 - 8	3 - 8	3 - 8	3 - 8	3 - 8	3 - 8	3 - 8	3 - 8	3 - 8
<b>Packed dimensions (Width x Depth x Height) (cm)</b>	Freestanding	49,4 x 66,1 x 89,1	49,4 x 66,1 x 89,1	49,4 x 66,1 x 89,1	49,4 x 66,1 x 89,1	49,4 x 66,1 x 89,1	49,4 x 66,1 x 89,1	49,4 x 66,1 x 89,1	49,4 x 66,1 x 89,1	49,4 x 66,1 x 89,1	49,4 x 66,1 x 89,1	49,4 x 66,1 x 89,1	49,4 x 66,1 x 89,1
	Semi-Integrated	49,4 x 66,1 x 86,1	49,4 x 66,1 x 86,1	49,4 x 66,1 x 86,1	49,4 x 66,1 x 86,1	49,4 x 66,1 x 86,1	49,4 x 66,1 x 86,1	49,4 x 66,1 x 86,1	49,4 x 66,1 x 86,1	49,4 x 66,1 x 86,1	49,4 x 66,1 x 86,1	49,4 x 66,1 x 86,1	49,4 x 66,1 x 86,1
	Fully Integrated	-	-	-	-	-	-	-	-	-	-	-	-
<b>Stacking quantity (pcs)</b>	Freestanding	6	6	6	6	6	6	6	6	6	6	6	6
	Semi-Integrated	6	6	6	6	6	6	6	6	6	6	6	6
	Fully Integrated	-	-	-	-	-	-	-	-	-	-	-	-
<b>Gross/Net weight (kg)(3)</b>	Freestanding	42 /40	42 /40	42 /40	42 /40	42 /40	42 /40	42 /40	42 /40	42 /40	42 /40	42 /40	42 /40
	Semi-Integrated	34 /32	34 /32	34 /32	34 /32	34 /32	34 /32	34 /32	34 /32	34 /32	34 /32	34 /32	34 /32
	Fully Integrated	-	-	-	-	-	-	-	-	-	-	-	-
<b>Container loading (40"HC/ 40"/ 20")</b>		216 or 251 /144 /72	216 or 251 /144 /72	216 or 251 /144 /72	216 or 251 /144 /72	216 or 251 /144 /72	216 or 251 /144 /72	216 or 251 /144 /72	216 or 251 /144 /72	216 or 251 /144 /72	216 or 251 /144 /72	216 or 251 /144 /72	216 or 251 /144 /72

Notes

(o) : Optional

(\*) : See roadmap for availability

(1) : Turbo Fan feature & Aquazone or Electrical Diverter system are default for 3rd basket models.

(2) : Based on the tests performed with Eco programme in accordance with European Household Dishwasher Performance Standards

(3) : Gross/Net Weights are shown as reference in the table. It should be calculated based on the final product features created from this general spec table.

Y SERIES 45cm Models BUILT-IN DISHWASHERS		Y11 45cm	Y1A 45cm	Y12 45cm	Y1B 45cm	Y13 45cm	Y1C 45cm	Y14 45cm
<b>General Characteristics</b>								
Number of place settings (PS)	10 PS (2 baskets)	Default	Default	Default	Default	Default	Default	Default
	10 PS (2 baskets + 3rd rack)	(o) with Aquazone and Turbo fan						
	11 PS (2 baskets + 3rd rack)	-	-	-	-	-	-	-
Number of programmes		2	2	3	3	4	4	5
Temperatures (°C)		50-65	50-65	50-65	50-65	40-50-65	40-50-65	40-50-65
Control type	Default	Button Control	Button Control	Button Control	Button Control	Button Control	Button Control	Button Control
	Option	-	-	-	-	-	-	-
Hidden heating element		Yes	Yes	Yes	Yes	Yes	Yes	Yes
Filter type	Metal	Default	Default	Default	Default	Default	Default	Default
	Plastic	-	-	-	-	-	-	-
Tub material		Stainless Steel						
Turbidity sensor (Smart Wash)		(o)	(o)	(o)	(o)	(o)	(o)	(o)
Drying system	Mini Active	Default	Default	Default	Default	Default	Default	Default
	Super Active	(o)	(o)	(o)	(o)	(o)	(o)	(o)
	Turbo	(o)	(o)	(o)	(o)	(o)	(o)	(o)
Electrical Diverter system		-	-	-	-	-	-	-
Overflow & leakage protection		Yes	Yes	Yes	Yes	Yes	Yes	Yes
Heater protection		Yes	Yes	Yes	Yes	Yes	Yes	Yes
Circulation pump	Asynchronous	Yes	Yes	Yes	Yes	Yes	Yes	Yes
	BLDC	-	-	-	-	-	-	-
Auto Door		-	-	-	-	-	-	-
Aquazone		(o)	(o)	(o)	(o)	(o)	(o)	(o)
Ion Tech*		(o)	(o)	(o)	(o)	(o)	(o)	(o)
Interior light	one spot	(o)	(o)	(o)	(o)	(o)	(o)	(o)
	four spot *	(o)	(o)	(o)	(o)	(o)	(o)	(o)
Available Aesthetics	Freestanding	Camelia Y, Flora Y, Iris Y, Kliky Y, Lydia Y, Tigris Y						
	Semi-Integrated	Camelia Y, Kliky Y, Lydia Y, Silva Y, Silva Y (Inox add-on)						
	Fully Integrated	-	-	-	-	-	-	-
Appliance Color Options		Black, Dark Gray, Dark Inox, Dark Silver, Inox, White						
<b>Programmes</b>								
Prewash		-	-	-	-	-	-	-
Mini 14' (Jet Wash)		-	-	-	-	-	-	-
Quick 30' 40°C		-	-	-	-	Yes	Yes	Yes
Eco (Standard Programme)		Yes	Yes	Yes	Yes	Yes	Yes	Yes
Super 50' 65°C (Quick Clean)		-	-	Yes	Yes	Yes	Yes	Yes
Super 55' 60°C		-	-	-	-	-	-	-
Delicate 40°C		-	-	-	-	-	-	Yes
Normal 55°C / Flexi Wash 55°C		-	-	-	-	-	-	-
Daily 60°C / Hybrid Wash 60°C		-	-	-	-	-	-	-
Dual Pro Wash 60°C		-	-	-	-	-	-	-
Hygiene 70°C		-	-	-	-	-	-	-
Intensive 65°C		Yes	Yes	Yes	Yes	Yes	Yes	Yes
Auto**		(o)	(o)	(o)	(o)	(o)	(o)	(o)
Auto Delicate 30°C - 50°C		-	-	-	-	-	-	-
Auto Normal 50°C - 60°C / Auto Flex 50°C - 60°C		-	-	-	-	-	-	-
Auto Intensive 60°C - 70°C		-	-	-	-	-	-	-
Steam Wash		-	-	-	-	-	-	-
<b>User Interface</b>								
Start/Pause button		Yes	Yes	Yes	Yes	Yes	Yes	Yes
DISPLAY TYPE (delay start, remaining time)		-	LED	-	LED	-	LED	-
Display Color	Default	-	Red	-	Red	-	Red	-
	Option	-	-	-	-	-	-	-
Prewash button		-	-	-	-	-	-	-
Programme selection button		Yes	Yes	Yes	Yes	Yes	Yes	Yes
Delay timer option	3hr,6hr,9hr	Yes	-	Yes	-	Yes	-	Yes
	1-2-3-...-19hr	-	Yes	-	Yes	-	Yes	-
	1-2-3-...-24hr	-	-	-	-	-	-	-
Eco Wash - Half load option	1 mode	Yes	Yes	Yes	Yes	Yes	Yes	Yes
	3 modes	-	-	-	-	-	-	-
Tablet option		-	Yes	-	Yes	-	Yes	-
Extra Hygiene option		-	Yes	-	Yes	-	Yes	-
Extra Rinse option		-	Yes	-	Yes	-	Yes	-
Extra Drying option		-	Yes	-	Yes	-	Yes	-
Extra Silent option (Silent Wash)		-	-	-	-	-	-	-
Extra Fast option		-	-	-	-	-	-	-
Energy Save option		-	-	-	-	-	-	-
Rinse-aid indicator		Yes	Yes	Yes	Yes	Yes	Yes	Yes
Salt indicator		Yes	Yes	Yes	Yes	Yes	Yes	Yes
Washing cycle indicators		Yes	Yes	Yes	Yes	Yes	Yes	Yes
End of cycle indicator		Yes	Yes	Yes	Yes	Yes	Yes	Yes
Child Lock		-	Yes	-	Yes	-	Yes	-
Buzzer		-	-	-	-	-	-	-
<b>Baskets &amp; Accessories</b>								
3rd basket (EasyTray) (1)	10 PS	(o)	(o)	(o)	(o)	(o)	(o)	(o)
Upper basket type		Peg	Peg	Peg	Peg	Peg	Peg	Peg
Adjustable upper basket [empty/ loaded 2 level / loaded 3 level*]		(o)	(o)	(o)	(o)	(o)	(o)	(o)
Number of mug shelves		4 (with 2 baskets)/, 2 (with 3rd basket)						
Mug shelves with soft touch rubber		(o)	(o)	(o)	(o)	(o)	(o)	(o)
Foldable racks on upper basket		(o)	(o)	(o)	(o)	(o)	(o)	(o)
Foldable racks on lower basket		(o)	(o)	(o)	(o)	(o)	(o)	(o)
Upper basket handle type [No / Plastic / Metal]		(o)	(o)	(o)	(o)	(o)	(o)	(o)
Lower basket handle type [No / Plastic / Metal]		(o)	(o)	(o)	(o)	(o)	(o)	(o)

Y SERIES 45cm Models BUILT-IN DISHWASHERS		Y1D 45cm	Y15 45cm	Y1E 45cm	Y1F 45cm	Y21 45cm	Y22 45cm	Y23 45cm	Y24 45cm	Y25 45cm
<b>General Characteristics</b>										
<b>Number of place settings (PS)</b>	10 PS (2 baskets)	Default	Default	Default	Default	Default	Default	Default	Default	Default
	10 PS (2 baskets + 3rd rack)	(o) with Aquazone and Turbo fan					(o) with Turbo fan			(o)
	11 PS (2 baskets + 3rd rack)	-	-	-	-	-	-	-	-	(o)
<b>Number of programmes</b>		5	6	6	7	6	7	8	9+	9+
<b>Temperatures (°C)</b>		40-50-65	40-50-65	40-50-65	40-50-60-65	40-50-65	40-50-60-65	40-50-60-65	Auto-30-40-50-60-65-70	Auto-30-40-50-60-65-70
<b>Control type</b>	Default	Button Control	Button Control	Button Control	Button Control	Button Control	Button Control	Button Control	Button Control	Button Control
	Option	-	-	-	-	-	-	-	-	-
<b>Hidden heating element</b>		Yes	Yes	Yes	Yes	Yes	Yes	Yes	Yes	Yes
<b>Filter type</b>	Metal	Default	Default	Default	Default	Default	Default	Default	Default	Default
	Plastic	-	-	-	-	-	-	-	-	-
<b>Tub material</b>										
<b>Turbidity sensor (Smart Wash)</b>		(o)	(o)	(o)	(o)	-	-	-	Yes	Yes
<b>Drying system</b>	Mini Active	Default	Default	Default	Default	Default	Default	Default	Default	-
	Super Active	(o)	(o)	(o)	(o)	(o)	(o)	(o)	(o)	-
	Turbo	(o)	(o)	(o)	(o)	(o)	(o)	(o)	(o)	Default
<b>Electrical Diverter system</b>		-	-	-	-	Yes	Yes	Yes	Yes	Yes
<b>Overflow &amp; leakage protection</b>		Yes	Yes	Yes	Yes	Yes	Yes	Yes	Yes	Yes
<b>Heater protection</b>		Yes	Yes	Yes	Yes	Yes	Yes	Yes	Yes	Yes
<b>Circulation pump</b>	Asynchronous	Yes	Yes	Yes	Yes	Yes	Yes	Yes	Yes	-
	BLDC	-	-	-	-	-	-	-	-	Yes
<b>Auto Door</b>		-	-	-	-	-	-	-	-	Yes
<b>Aquazone</b>		(o)	(o)	(o)	(o)	-	-	-	-	-
<b>Ion Tech*</b>		(o)	(o)	(o)	(o)	(o)	(o)	(o)	(o)	(o)
<b>Interior light</b>	one spot	(o)	(o)	(o)	(o)	(o)	(o)	(o)	(o)	(o)
	four spot *	(o)	(o)	(o)	(o)	(o)	(o)	(o)	(o)	(o)
<b>Available Aesthetics</b>	Freestanding	Camelia Y, Flora Y, Iris Y, Klikiya Y, Lydia Y, Tigris Y								Camelia Y, Flora Y
	Semi-Integrated	Camelia Y, Klikiya Y, Lydia Y, Silva Y, Silva Y (Inox add-on)								Camelia Y, Silva Y, Silva Y (Inox add-on)
	Fully Integrated	-	-	-	-	-	-	-	-	-
<b>Appliance Color Options</b>		Black, Dark Gray, Dark Inox, Dark Silver, Inox, White								
<b>Programmes</b>										
<b>Prewash</b>		-	Yes	Yes	Yes	Yes	Yes	Yes	Yes	Yes
<b>Mini 14' (Jet Wash)</b>		-	-	-	-	-	-	-	-	Yes
<b>Quick 30' 40°C</b>		Yes	Yes	Yes	Yes	Yes	Yes	Yes	Yes	Yes
<b>Eco (Standard Programme)</b>		Yes	Yes	Yes	Yes	Yes	Yes	Yes	Yes	Yes
<b>Super 50' 65°C (Quick Clean)</b>		Yes	Yes	Yes	Yes	Yes	Yes	Yes	Yes	Yes
<b>Super 55' 60°C</b>		-	-	-	-	-	-	-	-	-
<b>Delicate 40°C</b>		Yes	Yes	Yes	Yes	Yes	Yes	Yes	-	-
<b>Normal 55°C / Flexi Wash 55°C</b>		-	-	-	-	-	-	Yes	-	-
<b>Daily 60°C / Hybrid Wash 60°C</b>		-	-	-	Yes	-	Yes	Yes	Yes	-
<b>Dual Pro Wash 60°C</b>		-	-	-	-	-	-	-	-	Yes
<b>Hygiene 70°C</b>		-	-	-	-	-	-	-	-	Yes
<b>Intensive 65°C</b>		Yes	Yes	Yes	Yes	Yes	Yes	Yes	-	-
<b>Auto**</b>		(o)	(o)	(o)	(o)	(o)	-	-	-	-
<b>Auto Delicate 30°C - 50°C</b>		-	-	-	-	-	-	-	Yes	-
<b>Auto Normal 50°C - 60°C / Auto Flex 50°C - 60°C</b>		-	-	-	-	-	-	-	Yes	-
<b>Auto Intensive 60°C - 70°C</b>		-	-	-	-	-	-	-	Yes	Yes
<b>Steam Wash</b>		-	-	-	-	-	-	-	Yes	Yes
<b>User Interface</b>										
<b>Start/Pause button</b>		Yes	Yes	Yes	Yes	Yes	Yes	Yes	Yes	Yes
<b>DISPLAY TYPE (delay start, remaining time)</b>		LED	-	LED	LED	LED	LED	LED	LED	LED
<b>Display Color</b>	Default	Red	-	Red	Red	Red	Red	Red	Red	Red
	Option	-	-	-	-	-	-	-	-	-
<b>Prewash button</b>		-	-	-	-	-	-	-	-	-
<b>Programme selection button</b>		Yes	Yes	Yes	Yes	Yes	Yes	Yes	Yes	Yes
<b>Delay timer option</b>	3hr,6hr,9hr	-	Yes	-	-	-	-	-	-	-
	1-2-3-...-19hr	Yes	-	Yes	Yes	Yes	Yes	Yes	Yes	Yes
	1-2-3-...-24hr	-	-	-	-	-	-	-	-	-
<b>Eco Wash - Half load option</b>	1 mode	Yes	Yes	Yes	Yes	-	-	-	-	-
	3 modes	-	-	-	-	Yes	Yes	Yes	Yes	Yes
<b>Tablet option</b>		Yes	-	Yes	Yes	Yes	Yes	Yes	Yes	Yes
<b>Extra Hygiene option</b>		Yes	-	Yes	Yes	Yes	Yes	Yes	Yes	-
<b>Extra Rinse option</b>		Yes	-	Yes	Yes	Yes	Yes	Yes	Yes	-
<b>Extra Drying option</b>		Yes	-	Yes	Yes	Yes	Yes	Yes	Yes	-
<b>Extra Silent option (Silent Wash)</b>		-	-	-	-	-	-	-	-	Yes
<b>Extra Fast option</b>		-	-	-	-	-	-	-	-	Yes
<b>Energy Save option</b>		-	-	-	-	-	-	-	-	Yes
<b>Rinse-aid indicator</b>		Yes	Yes	Yes	Yes	Yes	Yes	Yes	Yes	Yes
<b>Salt indicator</b>		Yes	Yes	Yes	Yes	Yes	Yes	Yes	Yes	Yes
<b>Washing cycle indicators</b>		Yes	Yes	Yes	Yes	Yes	Yes	Yes	Yes	Yes
<b>End of cycle indicator</b>		Yes	Yes	Yes	Yes	Yes	Yes	Yes	Yes	Yes
<b>Child Lock</b>		Yes	-	Yes	Yes	Yes	Yes	Yes	Yes	Yes
<b>Buzzer</b>		-	-	-	-	-	-	-	-	Yes
<b>Baskets &amp; Accessories</b>										
<b>3rd basket (EasyTray) (1)</b>	10 PS	(o)	(o)	(o)	(o)	(o)	(o)	(o)	(o)	(o)
<b>Upper basket type</b>		Peg	Peg	Peg	Peg	Peg	Peg	Peg	Peg	Peg
<b>Adjustable upper basket [empty/ loaded 2 level / loaded 3 level*]</b>		(o)	(o)	(o)	(o)	(o)	(o)	(o)	(o)	(o)
<b>Mug shelves with soft touch rubber</b>		(o)	(o)	(o)	(o)	(o)	(o)	(o)	(o)	(o)
<b>Foldable racks on upper basket</b>		(o)	(o)	(o)	(o)	(o)	(o)	(o)	(o)	(o)

Y SERIES 45cm Models BUILT-IN DISHWASHERS		Y11 45cm	Y1A 45cm	Y12 45cm	Y1B 45cm	Y13 45cm	Y1C 45cm	Y14 45cm
<b>Baskets &amp; Accessories</b>								
<b>Removable cutlery basket (Single piece)</b>		-	-	-	-	-	-	-
<b>Removable cutlery basket (Universal)</b>		Yes	Yes	Yes	Yes	Yes	Yes	Yes
<b>Wine glass holder on lower basket</b>		(o) with foldable racks	(o) with foldable racks	(o) with foldable racks	(o) with foldable racks	(o) with foldable racks	(o) with foldable racks	(o) with foldable racks
<b>Top nozzle</b>	fixed type with 2 baskets	Default with 2 baskets	Default with 2 baskets	Default with 2 baskets	Default with 2 baskets	Default with 2 baskets	Default with 2 baskets	Default with 2 baskets
	rotating type	Default with 3rd basket	Default with 3rd basket	Default with 3rd basket	Default with 3rd basket	Default with 3rd basket	Default with 3rd basket	Default with 3rd basket
<b>Aquastop external hose</b>		(o)	(o)	(o)	(o)	(o)	(o)	(o)
<b>Antibacterial filter</b>		(o)	(o)	(o)	(o)	(o)	(o)	(o)
<b>Anti-siphon system</b>		-	-	-	-	-	-	-
<b>Technical Data (2)</b>								
<b>Sound level (dB(A) re 1 pW)</b>	10 PS	57 / 54 / 52 / 49 / 47 / 45	57 / 54 / 52 / 49 / 47 / 45	57 / 54 / 52 / 49 / 47 / 45	57 / 54 / 52 / 49 / 47 / 45	57 / 54 / 52 / 49 / 47 / 45	57 / 54 / 52 / 49 / 47 / 45	57 / 54 / 52 / 49 / 47 / 45
<b>Energy efficiency class</b>		A++	A++	A++	A++	A++	A++	A++
<b>Energy efficiency index</b>	10 PS	55,8	55,8	55,8	55,8	55,8	55,8	55,8
<b>Cleaning efficiency class</b>		A	A	A	A	A	A	A
<b>Cleaning efficiency index</b>		1,13	1,13	1,13	1,13	1,13	1,13	1,13
<b>Drying efficiency class</b>		A	A	A	A	A	A	A
<b>Drying efficiency index</b>		1,09	1,09	1,09	1,09	1,09	1,09	1,09
<b>Standard programme water consumption (lt / cycle)</b>	Default	11	11	11	11,0	11,0	11,0	11,0
	with Aquazone	9	9	9	9,0	9,0	9,0	9,0
<b>Annual water consumption (lt / year)</b>	Default	3080	3080	3080	3080	3080	3080	3080
	with Aquazone	2520	2520	2520	2520	2520	2520	2520
<b>Duration of the standard programme (min)</b>	Default	198	198	198	198	198	198	198
	with Aquazone	222	222	222	222	222	222	222
<b>Standard programme energy consumption (kWh / cycle)</b>	10 PS	0,732	0,732	0,732	0,732	0,732	0,732	0,732
<b>Annual energy consumption (kWh/ year)</b>	10 PS	211	211	211	211	211	211	211
<b>Off mode power consumption (W)</b>		0,50	0,50	0,50	0,50	0,50	0,50	0,50
<b>Left-on mode power consumption (W)</b>		1,00	1,00	1,00	1,00	1,00	1,00	1,00
<b>Network standby mode power consumption (W)</b>		N/A	N/A	N/A	N/A	N/A	N/A	N/A
<b>Duration of left-on mode (min)</b>		N/A	N/A	N/A	N/A	N/A	N/A	N/A
<b>Power rating (W) / Heating element (W)</b>		1900 / 1800	1900 / 1800	1900 / 1800	1900 / 1800	1900 / 1800	1900 / 1800	1900 / 1800
<b>Plug Type</b>		EU / UK / Swiss / Italy / Israel / AU/NZ / China / Argentina / S.Africa						
<b>Power cord length (cm)</b>		165	165	165	165	165	165	165
<b>Water inlet hose length (cm)</b>	Default	147	147	147	147	147	147	147
	with Aquastop ext. hose	170	170	170	170	170	170	170
<b>Water outlet hose length (cm)</b>		200	200	200	200	200	200	200
<b>Voltage (V) / Frequency (Hz) / Fuse Rating (A)</b>		220-240 / 50 / 10	220-240 / 50 / 10	220-240 / 50 / 10	220-240 / 50 / 10	220-240 / 50 / 10	220-240 / 50 / 10	220-240 / 50 / 10
<b>Water pressure range (bar)</b>		0,3 - 10	0,3 - 10	0,3 - 10	0,3 - 10	0,3 - 10	0,3 - 10	0,3 - 10
<b>Dimensions</b>								
<b>Height (cm)</b>	Freestanding	85,0	85,0	85,0	85,0	85,0	85,0	85,0
	Semi-Integrated	82,0	82,0	82,0	82,0	82,0	82,0	82,0
	Fully Integrated	-	-	-	-	-	-	-
<b>Width (cm)</b>		44,8	44,8	44,8	44,8	44,8	44,8	44,8
<b>Depth (cm)</b>	Freestanding	59,8	59,8	59,8	59,8	59,8	59,8	59,8
	Semi-Integrated	57,0	57,0	57,0	57,0	57,0	57,0	57,0
	Fully Integrated	-	-	-	-	-	-	-
<b>Height adjustment (+cm)</b>	Freestanding	2	2	2	2	2	2	2
	Semi-Integrated	5	5	5	5	5	5	5
	Fully Integrated	-	-	-	-	-	-	-
<b>Adjustable Plinth for undertable usage (mm) Undertable</b>		(o) (80 or/ and 130)	(o) (80 or/ and 130)	(o) (80 or/ and 130)	(o) (80 or/ and 130)	(o) (80 or/ and 130)	(o) (80 or/ and 130)	(o) (80 or/ and 130)
<b>Possible adjustment of the plinth Undertable (horizontal / vertical) (mm / mm)</b>		0-100 / 0-50	0-100 / 0-50	0-100 / 0-50	0-100 / 0-50	0-100 / 0-50	0-100 / 0-50	0-100 / 0-50
<b>Height without worktop (cm) Undertable</b>		82,0	82,0	82,0	82,0	82,0	82,0	82,0
<b>Decorative panel height (max) (cm) Semi-Integrated</b>		59,7	59,7	59,7	59,7	59,7	59,7	59,7
<b>Plinth height (min) (cm) Semi-Integrated</b>		8	8	8	8	8	8	8
<b>Plinth depth (cm) Semi-Integrated</b>		3 - 8	3 - 8	3 - 8	3 - 8	3 - 8	3 - 8	3 - 8
<b>Packed dimensions (Width x Depth x Height) (cm)</b>	Freestanding	49.4 x 66.1 x 89.1	49.4 x 66.1 x 89.1	49.4 x 66.1 x 89.1	49.4 x 66.1 x 89.1	49.4 x 66.1 x 89.1	49.4 x 66.1 x 89.1	49.4 x 66.1 x 89.1
	Semi-Integrated	49.4 x 66.1 x 86.1	49.4 x 66.1 x 86.1	49.4 x 66.1 x 86.1	49.4 x 66.1 x 86.1	49.4 x 66.1 x 86.1	49.4 x 66.1 x 86.1	49.4 x 66.1 x 86.1
	Fully Integrated	-	-	-	-	-	-	-
<b>Stacking quantity (pcs)</b>	Freestanding	6	6	6	6	6	6	6
	Semi-Integrated	6	6	6	6	6	6	6
	Fully Integrated	-	-	-	-	-	-	-
<b>Gross/Net weight (kg)(3)</b>	Freestanding	42 /40	42 /40	42 /40	42 /40	42 /40	42 /40	42 /40
	Semi-Integrated	34 /32	34 /32	34 /32	34 /32	34 /32	34 /32	34 /32
	Fully Integrated	-	-	-	-	-	-	-
<b>Container loading (40"HC/ 40" / 20")</b>		216 or 251 /144 /72	216 or 251 /144 /72	216 or 251 /144 /72	216 or 251 /144 /72	216 or 251 /144 /72	216 or 251 /144 /72	216 or 251 /144 /72



Y SERIES 45cm Models BUILT-IN DISHWASHERS		Y1D 45cm	Y15 45cm	Y1E 45cm	Y1F 45cm	Y21 45cm	Y22 45cm	Y23 45cm	Y24 45cm	Y25 45cm
<b>Baskets &amp; Accessories</b>										
<b>Foldable racks on lower basket</b>		(o)	(o)	(o)	(o)	(o)	(o)	(o)	(o)	(o)
<b>Upper basket handle type [No / Plastic / Metal]</b>		(o)	(o)	(o)	(o)	(o)	(o)	(o)	(o)	(o)
<b>Lower basket handle type [No / Plastic / Metal]</b>		(o)	(o)	(o)	(o)	(o)	(o)	(o)	(o)	(o)
<b>Removable cutlery basket (Single piece)</b>		-	-	-	-	-	-	-	-	-
<b>Removable cutlery basket (Universal)</b>		Yes	Yes	Yes	Yes	(Yes) with 2 baskets/ (o) with 3rd basket				(Yes) with 2 baskets/ (o) with 3rd basket
<b>Wine glass holder on lower basket</b>		(o) with foldable racks	(o) with foldable racks	(o) with foldable racks	(o) with foldable racks	(o) with foldable racks	(o) with foldable racks	(o) with foldable racks	(o) with foldable racks	(o) with foldable racks
<b>Top nozzle</b>	fixed type with 2 baskets	Default with 2 baskets	Default with 2 baskets	Default with 2 baskets	Default with 2 baskets	Default with 2 baskets	Default with 2 baskets	Default with 2 baskets	Default with 2 baskets	Default with 2 baskets
	rotating type	Default with 3rd basket	Default with 3rd basket	Default with 3rd basket	Default with 3rd basket	Default with 3rd basket	Default with 3rd basket	Default with 3rd basket	Default with 3rd basket	Default with 3rd basket
<b>Aquastop external hose</b>		(o)	(o)	(o)	(o)	(o)	(o)	(o)	(o)	(o)
<b>Antibacterial filter</b>		(o)	(o)	(o)	(o)	(o)	(o)	(o)	(o)	(o)
<b>Anti-siphon system</b>		-	-	-	-	-	-	-	-	-
<b>Technical Data (2)</b>										
<b>Sound level (dB(A) re 1 pW)</b>	10 PS	57 / 54 / 52 / 49 / 47 / 45	57 / 54 / 52 / 49 / 47 / 45	57 / 54 / 52 / 49 / 47 / 45	57 / 54 / 52 / 49 / 47 / 45	57 / 54 / 52 / 49 / 47 / 45	57 / 54 / 52 / 49 / 47 / 45	57 / 54 / 52 / 49 / 47 / 45	57 / 54 / 52 / 49 / 47 / 45	44
<b>Energy efficiency class</b>		A++	A++	A++	A++	A++	A++	A++	A++	A+++
<b>Energy efficiency index</b>	10 PS	55,8	55,8	55,8	55,8	55,8	55,8	55,8	55,8	49,7
<b>Cleaning efficiency class</b>		A	A	A	A	A	A	A	A	A
<b>Cleaning efficiency index</b>		1,13	1,13	1,13	1,13	1,13	1,13	1,13	1,13	1,13
<b>Drying efficiency class</b>		A	A	A	A	A	A	A	A	A
<b>Drying efficiency index</b>		1,09	1,09	1,09	1,09	1,09	1,09	1,09	1,09	1,09
<b>Standard programme water consumption (lt / cycle)</b>	Default	11,0	11,0	11,0	11,0	9,0	9,0	9,0	9,0	9,0
	with Aquazone	9,0	9,0	9,0	9,0	-	-	-	-	-
<b>Annual water consumption (lt / year)</b>	Default	3080	3080	3080	3080	2520	2520	2520	2520	2520
	with Aquazone	2520	2520	2520	2520	-	-	-	-	-
<b>Duration of the standard programme (min)</b>	Default	198	198	198	198	198	198	198	198	185
	with Aquazone	222	222	222	222	-	-	-	-	-
<b>Standard programme energy consumption (kWh / cycle)</b>	10 PS	0,732	0,732	0,732	0,732	0,732	0,732	0,732	0,732	0,650
<b>Annual energy consumption (kWh / year)</b>	10 PS	211	211	211	211	211	211	211	211	188
<b>Off mode power consumption (W)</b>		0,50	0,50	0,50	0,50	0,50	0,50	0,50	0,50	0,50
<b>Left-on mode power consumption (W)</b>		1,00	1,00	1,00	1,00	1,00	1,00	1,00	1,00	1,00
<b>Network standby mode power consumption (W)</b>		N/A	N/A	N/A	N/A	N/A	N/A	N/A	N/A	N/A
<b>Duration of left-on mode (min)</b>		N/A	N/A	N/A	N/A	N/A	N/A	N/A	N/A	N/A
<b>Power rating (W) / Heating element (W)</b>		1900 / 1800	1900 / 1800	1900 / 1800	1900 / 1800	1900 / 1800	1900 / 1800	1900 / 1800	1900 / 1800	1900 / 1800
<b>Plug Type</b>										
<b>Power cord length (cm)</b>		165	165	165	165	165	165	165	165	165
<b>Water inlet hose length (cm)</b>	Default	147	147	147	147	147	147	147	147	147
	with Aquastop ext. hose	170	170	170	170	170	170	170	170	170
<b>Water outlet hose length (cm)</b>		200	200	200	200	200	200	200	200	200
<b>Voltage (V) / Frequency (Hz) / Fuse Rating (A)</b>		220-240 / 50 / 10	220-240 / 50 / 10	220-240 / 50 / 10	220-240 / 50 / 10	220-240 / 50 / 10	220-240 / 50 / 10	220-240 / 50 / 10	220-240 / 50 / 10	220-240 / 50 / 10
<b>Water pressure range (bar)</b>		0,3 - 10	0,3 - 10	0,3 - 10	0,3 - 10	0,3 - 10	0,3 - 10	0,3 - 10	0,3 - 10	0,3 - 10
<b>Dimensions</b>										
<b>Height (cm)</b>	Freestanding	85,0	85,0	85,0	85,0	85,0	85,0	85,0	85,0	85,0
	Semi-Integrated	82,0	82,0	82,0	82,0	82,0	82,0	82,0	82,0	82,0
	Fully Integrated	-	-	-	-	-	-	-	-	-
<b>Width (cm)</b>		44,8	44,8	44,8	44,8	44,8	44,8	44,8	44,8	44,8
<b>Depth (cm)</b>	Freestanding	59,8	59,8	59,8	59,8	59,8	59,8	59,8	59,8	59,8
	Semi-Integrated	57,0	57,0	57,0	57,0	57,0	57,0	57,0	57,0	57,0
	Fully Integrated	-	-	-	-	-	-	-	-	-
<b>Height adjustment (+cm)</b>	Freestanding	2	2	2	2	2	2	2	2	2
	Semi-Integrated	5	5	5	5	5	5	5	5	5
	Fully Integrated	-	-	-	-	-	-	-	-	-
<b>Adjustable Plinth for undertable usage (mm) Undertable</b>		(o) (80 or/ and 130)	(o) (80 or/ and 130)	(o) (80 or/ and 130)	(o) (80 or/ and 130)	(o) (80 or/ and 130)	(o) (80 or/ and 130)	(o) (80 or/ and 130)	(o) (80 or/ and 130)	(o) (80 or/ and 130)
<b>Possible adjustment of the plinth Undertable (horizontal / vertical) (mm / mm)</b>		0-100 / 0-50	0-100 / 0-50	0-100 / 0-50	0-100 / 0-50	0-100 / 0-50	0-100 / 0-50	0-100 / 0-50	0-100 / 0-50	0-100 / 0-50
<b>Height without worktop (cm) Undertable</b>		82,0	82,0	82,0	82,0	82,0	82,0	82,0	82,0	82,0
<b>Decorative panel height (max) (cm) Semi-Integrated</b>		59,7	59,7	59,7	59,7	59,7	59,7	59,7	59,7	59,7
<b>Plinth height (min) (cm) Semi-Integrated</b>		8	8	8	8	8	8	8	8	8
<b>Plinth depth (cm) Semi-Integrated</b>		3 - 8	3 - 8	3 - 8	3 - 8	3 - 8	3 - 8	3 - 8	3 - 8	3 - 8
<b>Packed dimensions (Width x Depth x Height) (cm)</b>	Freestanding	49,4 x 66,1 x 89,1	49,4 x 66,1 x 89,1	49,4 x 66,1 x 89,1	49,4 x 66,1 x 89,1	49,4 x 66,1 x 89,1	49,4 x 66,1 x 89,1	49,4 x 66,1 x 89,1	49,4 x 66,1 x 89,1	49,4 x 66,1 x 89,1
	Semi-Integrated	49,4 x 66,1 x 86,1	49,4 x 66,1 x 86,1	49,4 x 66,1 x 86,1	49,4 x 66,1 x 86,1	49,4 x 66,1 x 86,1	49,4 x 66,1 x 86,1	49,4 x 66,1 x 86,1	49,4 x 66,1 x 86,1	49,4 x 66,1 x 86,1
	Fully Integrated	-	-	-	-	-	-	-	-	-
<b>Stacking quantity (pcs)</b>	Freestanding	6	6	6	6	6	6	6	6	6
	Semi-Integrated	6	6	6	6	6	6	6	6	6
	Fully Integrated	-	-	-	-	-	-	-	-	-
<b>Gross/Net weight (kg)(3)</b>	Freestanding	42 /40	42 /40	42 /40	42 /40	42 /40	42 /40	42 /40	42 /40	42 /40
	Semi-Integrated	34 /32	34 /32	34 /32	34 /32	34 /32	34 /32	34 /32	34 /32	34 /32
	Fully Integrated	-	-	-	-	-	-	-	-	-
<b>Container loading (40"HC / 40" / 20")</b>		216 or 251 /144 /72	216 or 251 /144 /72	216 or 251 /144 /72	216 or 251 /144 /72	216 or 251 /144 /72	216 or 251 /144 /72	216 or 251 /144 /72	216 or 251 /144 /72	216 or 251 /144 /72

Notes

(o) : Optional

(\*) : See roadmap for availability

(1) : Turbo Fan feature & Aquazone or Electrical Diverter system are default for 3rd basket models.

(2) : Based on the tests performed with Eco programme in accordance with European Household Dishwasher Performance Standards

(3) : Gross/Net Weights are shown as reference in the table. It should be calculated based on the final product features created from this general spect table.

T1-2 SERIES 45cm Models BUILT-IN DISHWASHERS		T14 45cm	T15 45cm	T21 45cm	T22 45cm	T24 45cm
<b>General Characteristics</b>						
<b>Number of place settings (PS)</b>	10 PS (2 baskets)	Default	Default	Default	Default	Default
	10 PS (2 baskets + 3rd rack)	(o) with Aquazone and Turbo fan	(o) with Aquazone and Turbo fan	(o) with Turbo fan	(o)	(o)
	11 PS (2 baskets + 3rd rack)	-	-	-	-	(o)
<b>Number of programmes</b>		7	7	8+	8+	8+
<b>Temperatures (°C)</b>		40-50-65-70	40-50-65-70	Auto-30-40-50-60-65-70	Auto-30-40-50-60-65-70	Auto-30-40-50-60-65-70
<b>Control type</b>	Default	Button Control	Button Control	Button Control	Button Control	Button Control
	Option	-	-	-	-	-
<b>Hidden heating element</b>		Yes	Yes	Yes	Yes	Yes
<b>Filter type</b>	Metal	Default	Default	Default	Default	Default
	Plastic	-	-	-	-	-
<b>Tube material</b>		Stainless Steel	Stainless Steel	Stainless Steel	Stainless Steel	Stainless Steel
<b>Turbidity sensor (Smart Wash)</b>		(o)	(o)	Yes	Yes	Yes
<b>Drying system</b>	Mini Active	Default	Default	Default	-	-
	Super Active	(o)	(o)	(o)	-	-
	Turbo	(o)	(o)	(o)	Default	Default
<b>Electrical Diverter system</b>		-	-	Yes	Yes	Yes
<b>Overflow &amp; leakage protection</b>		Yes	Yes	Yes	Yes	Yes
<b>Heater protection</b>		Yes	Yes	Yes	Yes	Yes
<b>Circulation pump</b>	Asynchronous	Yes	Yes	Yes	Yes	-
	BLDC	-	-	-	-	Yes
<b>Auto Door</b>		-	-	-	-	Yes
<b>Aquazone</b>		(o)	(o)	-	-	-
<b>Ion Tech*</b>		(o)	(o)	(o)	(o)	(o)
<b>Interior light</b>	one spot	(o)	(o)	(o)	(o)	(o)
	four spot *	(o)	(o)	(o)	(o)	(o)
<b>Available Aesthetics</b>	Freestanding	Claros, Iris T, Nebula, Vento	Claros, Iris T, Nebula, Vento	Claros, Iris T, Nebula, Vento	Claros, Iris T, Nebula, Vento	Claros, Iris T, Nebula, Vento
	Semi-Integrated	Vento	Vento	Vento	Vento	Vento
	Fully Integrated	-	-	-	-	-
<b>Appliance Color Options</b>		Black, Dark Gray, Dark Inox, Dark Silver, Inox, White	Black, Dark Gray, Dark Inox, Dark Silver, Inox, White	Black, Dark Gray, Dark Inox, Dark Silver, Inox, White	Black, Dark Gray, Dark Inox, Dark Silver, Inox, White	Black, Dark Gray, Dark Inox, Dark Silver, Inox, White
<b>Programmes</b>						
<b>Prewash</b>		Yes	Yes	Yes	Yes	Yes
<b>Mini 14' (Jet Wash)</b>		-	-	-	-	-
<b>Quick 30' 40°C</b>		Yes	Yes	Yes	Yes	Yes
<b>Eco (Standard Programme)</b>		Yes	Yes	Yes	Yes	Yes
<b>Super 50' 65°C (Quick Clean)</b>		Yes	Yes	Yes	Yes	Yes
<b>Delicate 40°C</b>		Yes	Yes	-	-	-
<b>Dual Pro Wash 60°C</b>		-	-	-	-	Yes
<b>Hygiene 70°C</b>		Yes	Yes	Yes	Yes	Yes
<b>Intensive 65°C</b>		Yes	Yes	-	-	-
<b>Auto**</b>		(o)	(o)	-	-	-
<b>Auto Delicate 30°C - 50°C</b>		-	-	Yes	Yes	Yes
<b>Auto Normal 50°C - 60°C / Auto Flex 50°C - 60°C</b>		-	-	Yes	Yes	-
<b>Auto Intensive 60°C - 70°C</b>		-	-	Yes	Yes	Yes (50°C - 70°C)
<b>User Interface</b>						
<b>Start/Pause button</b>		Yes	Yes	Yes	Yes	Yes
<b>DISPLAY TYPE (delay start, remaining time)</b>		LED	-	LED	LED	LED
<b>Display Color</b>	Default	Red	-	Red	Red	Red
	Option	-	-	-	-	-
<b>Programme selection button</b>		Yes	Yes	Yes	Yes	Yes
<b>Delay timer option</b>	3hr,6hr,9hr	-	Yes	-	-	-
	1-2-3-...-19hr	-	-	-	-	-
	1-2-3-...-24hr	Yes	-	Yes	Yes	Yes
<b>Eco Wash - Half load option</b>	1 mode	Yes	-	-	-	-
	3 modes	-	-	Yes	Yes	Yes
<b>Tablet option</b>		Yes	-	Yes	Yes	-
<b>Extra Rinse option</b>		Yes	-	Yes	Yes	-
<b>Extra Drying option</b>		-	-	Yes	Yes	-
<b>Extra Silent option (Silent Wash)</b>		-	-	-	-	Yes
<b>Extra Fast option</b>		-	-	-	-	Yes
<b>Energy Save option</b>		-	-	-	-	Yes
<b>Rinse-aid indicator</b>		Yes	Yes	Yes	Yes	Yes

T1-2 SERIES 45cm Models BULIT-IN DISHWASHERS		T14 45cm	T15 45cm	T21 45cm	T22 45cm	T24 45cm
<b>User Interface</b>						
Salt indicator		Yes	Yes	Yes	Yes	Yes
Washing cycle indicators		Yes	Yes	Yes	Yes	Yes
End of cycle indicator		Yes	Yes	Yes	Yes	Yes
Child Lock		Yes	-	Yes	Yes	Yes
Buzzer		-	-	-	-	Yes
<b>Baskets &amp; Accessories</b>						
3rd basket (EasyTray) (1)	10 PS	(o)	(o)	(o)	(o)	(o)
Upper basket type		Peg	Peg	Peg	Peg	Peg
Adjustable upper basket [empty/ loaded 2 level / loaded 3 level*]		(o)	(o)	(o)	(o)	(o)
Number of mug shelves		4 (with 2 baskets)/ 2 (with 3rd basket)	4 (with 2 baskets)/ 2 (with 3rd basket)	4 (with 2 baskets)/ 2 (with 3rd basket)	4 (with 2 baskets)/ 2 (with 3rd basket)	4 (with 2 baskets)/ 2 (with 3rd basket)
Adjustable mug shelves		-	-	-	-	-
Mug shelves with soft touch rubber		(o)	(o)	(o)	(o)	(o)
Foldable racks on upper basket		(o)	(o)	(o)	(o)	(o)
Foldable racks on lower basket		(o)	(o)	(o)	(o)	(o)
Upper basket handle type [No / Plastic / Metal]		(o)	(o)	(o)	(o)	(o)
Lower basket handle type [No / Plastic / Metal]		(o)	(o)	(o)	(o)	(o)
Removable cutlery basket (Single piece)		-	-	-	-	-
Removable cutlery basket (Universal)		Yes	Yes	Yes	(Yes) with 2 baskets/ (o) with 3rd basket	(Yes) with 2 baskets/ (o) with 3rd basket
Wine glass holder on lower basket		(o) with foldable racks	(o) with foldable racks	(o) with foldable racks	(o) with foldable racks	(o) with foldable racks
Top nozzle	fixed type with 2 baskets	Default with 2 baskets	Default with 2 baskets	Default with 2 baskets	Default with 2 baskets	Default with 2 baskets
	rotating type	Default with 3rd basket	Default with 3rd basket	Default with 3rd basket	Default with 3rd basket	Default with 3rd basket
Aquastop external hose		(o)	(o)	(o)	(o)	(o)
Antibacterial filter		(o)	(o)	(o)	(o)	(o)
<b>Technical Data (2)</b>						
Sound level (dB(A) re 1 pW)	10 PS	57 / 54 / 52 / 49 / 47 / 45	57 / 54 / 52 / 49 / 47 / 45	57 / 54 / 52 / 49 / 47 / 45	52 / 49 / 47 / 45	44
Energy efficiency class		A++	A++	A++	A++	A+++
Energy efficiency index	10 PS	55,8	55,8	55,8	55,8	49,7
Cleaning efficiency class		A	A	A	A	A
Cleaning efficiency index		1,13	1,13	1,13	1,13	1,13
Drying efficiency class		A	A	A	A	A
Drying efficiency index		1,09	1,09	1,09	1,09	1,09
Standard programme water consumption (lt / cycle)	Default	11,0	11,0	9,0	9,0	9,0
	with Aquazone	9,0	9,0	-	-	-
Annual water consumption (lt / year)	Default	3080	3080	2520	2520	2520
	with Aquazone	2520	2520	-	-	-
Duration of the standard programme (min)	Default	198	198	198	198	185
	with Aquazone	222	222	-	-	-
Standard programme energy consumption (kWh / cycle)	10 PS	0,732	0,732	0,732	0,732	0,650
Annual energy consumption (kWh / year)	10 PS	211	211	211	211	188
Off mode power consumption (W)		0,50	0,50	0,50	0,50	0,50
Left-on mode power consumption (W)		1,00	1,00	1,00	1,00	1,00
Network standby mode power consumption (W)		N/A	N/A	N/A	N/A	N/A
Duration of left-on mode (min)		N/A	N/A	N/A	N/A	N/A
Power rating (W) / Heating element (W)		1900 / 1800	1900 / 1800	1900 / 1800	1900 / 1800	1900 / 1800
Plug Type		EU / UK / Swiss / Italy / Israel / AU/NZ / China / Argentina / S.Africa	EU / UK / Swiss / Italy / Israel / AU/NZ / China / Argentina / S.Africa	EU / UK / Swiss / Italy / Israel / AU/NZ / China / Argentina / S.Africa	EU / UK / Swiss / Italy / Israel / AU/NZ / China / Argentina / S.Africa	EU / UK / Swiss / Italy / Israel / AU/NZ / China / Argentina / S.Africa
Power cord length (cm)		165	165	165	165	165
Water inlet hose length (cm)	Default	147	147	147	147	147
	with Aquastop ext. hose	170	170	170	170	170
Water outlet hose length (cm)		200	200	200	200	200
Voltage (V) / Frequency (Hz) / Fuse Rating (A)		220-240 / 50 / 10	220-240 / 50 / 10	220-240 / 50 / 10	220-240 / 50 / 10	220-240 / 50 / 10
Water pressure range (bar)		0,3 - 10	0,3 - 10	0,3 - 10	0,3 - 10	0,3 - 10

T1-2 SERIES 45cm Models BUILT-IN DISHWASHERS		T14 45cm	T15 45cm	T21 45cm	T22 45cm	T24 45cm
<b>Dimensions</b>						
<b>Height (cm)</b>	Freestanding	85,0	85,0	85,0	85,0	85,0
	Semi-Integrated	82,0	82,0	82,0	82,0	82,0
	Fully Integrated	-	-	-	-	-
<b>Width (cm)</b>		44,8	44,8	44,8	44,8	44,8
<b>Depth (cm)</b>	Freestanding	59,8	59,8	59,8	59,8	59,8
	Semi-Integrated	57,0	57,0	57,0	57,0	57,0
	Fully Integrated	-	-	-	-	-
<b>Height adjustment (+cm)</b>	Freestanding	2	2	2	2	2
	Semi-Integrated	5	5	5	5	5
	Fully Integrated	-	-	-	-	-
<b>Adjustable Plinth for undertable usage (mm) Undertable</b>		(o) (80 or/and 130)	(o) (80 or/and 130)	(o) (80 or/and 130)	(o) (80 or/and 130)	(o) (80 or/and 130)
<b>Possible adjustment of the plinth Undertable (horizontal / vertical) (mm / mm)</b>		0-100 / 0-50	0-100 / 0-50	0-100 / 0-50	0-100 / 0-50	0-100 / 0-50
<b>Height without worktop (cm) Undertable</b>		82,0	82,0	82,0	82,0	82,0
<b>Decorative panel height (max) (cm) Semi-Integrated</b>		59,7	59,7	59,7	59,7	59,7
<b>Plinth height (min) (cm) Semi-Integrated</b>		8	8	8	8	8
<b>Plinth depth (cm) Semi-Integrated</b>		3 - 8	3 - 8	3 - 8	3 - 8	3 - 8
<b>Packed dimensions (Width x Depth x Height) (cm)</b>	Freestanding	49.4 x 66.1 x 89.1	49.4 x 66.1 x 89.1	49.4 x 66.1 x 89.1	49.4 x 66.1 x 89.1	49.4 x 66.1 x 89.1
	Semi-Integrated	49.4 x 66.1 x 86.1	49.4 x 66.1 x 86.1	49.4 x 66.1 x 86.1	49.4 x 66.1 x 86.1	49.4 x 66.1 x 86.1
	Fully Integrated	-	-	-	-	-
<b>Stacking quantity (pcs)</b>	Freestanding	6	6	6	6	6
	Semi-Integrated	6	6	6	6	6
	Fully Integrated	-	-	-	-	-
<b>Gross/Net weight (kg)(3)</b>	Freestanding	42 /40	42 /40	42 /40	42 /40	42 /40
	Semi-Integrated	34 /32	34 /32	34 /32	34 /32	34 /32
	Fully Integrated	-	-	-	-	-
<b>Container loading (40"HC/ 40" / 20")</b>		216 or 251 /144 /72	216 or 251 /144 /72	216 or 251 /144 /72	216 or 251 /144 /72	216 or 251 /144 /72

Notes

(o) : Optional

(\*) : See roadmap for availability

(1) : Turbo Fan feature & Aquazone or Electrical Diverter system are default for 3rd basket models.

(2) : Based on the tests performed with Eco programme in accordance with European Household Dishwasher Performance Standards

(3) : Gross/Net Weights are shown as reference in the table. It should be calculated based on the final product features created from this general spect table.



45cm Models INTEGRATED		D12 45cm	D21 45cm	Z21 45cm	D22 45cm	D32 45cm
<b>General Characteristics</b>						
Number of place settings (PS)	10 PS (2 baskets)	Default	Default	Default	Default	Default
	10 PS (2 baskets + 3rd rack)	(o) with Aquazone and Turbo fan	(o) with Aquazone and Turbo fan	(o) with Aquazone and Turbo fan	(o) with Aquazone and Turbo fan	(o) with Aquazone and Turbo fan
	11 PS (2 baskets + 3rd rack)	-	-	-	-	-
Number of programmes		3	5	5	6	8
Temperatures (°C)		50-65	40-50-65-70	40-50-65-70	40-50-65-70	40-50-60-65-70
Control type	Default	Button Control	Button Control	Button Control	Button Control	Button Control
	Option	-	-	-	-	-
Hidden heating element		Yes	Yes	Yes	Yes	Yes
Filter type	Metal	Default	Default	Default	Default	Default
	Plastic	-	-	-	-	-
Tub material		Stainless Steel	Stainless Steel	Stainless Steel	Stainless Steel	Stainless Steel
Turbidity sensor (Smart Wash)		(o)	(o)	(o)	(o)	(o)
Drying system	Mini Active	Default	Default	Default	Default	Default
	Super Active	(o)	(o)	(o)	(o)	(o)
	Turbo	(o)	(o)	(o)	(o)	(o)
Electrical Diverter system		-	-	-	-	-
Overflow & leakage protection		Yes	Yes	Yes	Yes	Yes
Heater protection		Yes	Yes	Yes	Yes	Yes
Circulation pump	Asynchronous	Yes	Yes	Yes	Yes	Yes
	BLDC	-	-	-	-	-
Aquazone		(o)	(o)	(o)	(o)	(o)
Sliding Door		(o)	(o)	(o)	(o)	(o)
Ion Tech*		(o)	(o)	(o)	(o)	(o)
InfoLED	1,0	-	-	-	-	(o)
	2.0 (Floor Indicator)	-	-	-	-	-
Interior light	one spot	-	-	-	-	-
	four spot *	-	-	-	-	-
Available Aesthetics	Freestanding	-	-	-	-	-
	Semi-Integrated	-	-	-	-	-
	Fully Integrated	Alinda, Spero	Alinda, Spero	Alinda, Spero	Alinda, Spero	Alinda, Spero
<b>Programmes</b>						
Prewash		Yes	Yes	Yes	Yes	Yes
Mini 14' (Jet Wash)		-	-	-	-	-
Quick 30' 40°C		-	Yes	Yes	Yes	Yes
Eco (Standard Programme)		Yes	Yes	Yes	Yes	Yes
Super 50' 65°C (Quick Clean)		-	Yes	Yes	Yes	Yes
Hygiene 70°C		-	-	-	Yes	Yes
Intensive 65°C		Yes	Yes	Yes	Yes	Yes
Auto**		(o)	(o)	(o)	(o)	(o)
Auto Delicate 30°C - 50°C		-	-	-	-	-
Auto Normal 50°C - 60°C / Auto Flex 50°C - 60°C		-	-	-	-	-
Auto Intensive 60°C - 70°C		-	-	-	-	-
DISPLAY TYPE (delay start, remaining time)		-	LED One digit	LED One digit	LED One digit	LED Hidden display
Display Color	Default	-	Red	Red	Red	Red
	Option	-	-	-	-	-
Programme selection button		Yes	Yes	Yes	Yes	Yes
Delay timer option	3hr,6hr,9hr	-	Yes	Yes	Yes	-
	1-2-3-...-19hr	-	-	-	-	Yes
	1-2-3-...-24hr	-	-	-	-	-
Eco Wash - Half load option	1 mode	-	Yes	Yes	Yes	Yes
	3 modes	-	-	-	-	-
Tablet option		-	-	Yes	-	Yes
Extra Rinse option		-	-	-	-	-
Extra Silent option (Silent Wash)		-	-	-	-	-
Extra Fast option		-	-	-	-	-
Energy Save option		-	-	-	-	-
Rinse-aid indicator		Yes	Yes	Yes	Yes	Yes
Salt indicator		Yes	Yes	Yes	Yes	Yes
End of cycle indicator		Yes	Yes	Yes	Yes	Yes
Buzzer		Yes	Yes	Yes	Yes	Yes
<b>Baskets &amp; Accessories</b>						
3rd basket (EasyTray) (1)		10 PS	(o)	(o)	(o)	(o)
Upper basket type		Peg	Peg	Peg	Peg	Peg
Adjustable upper basket [empty/ loaded 2 level / loaded 3 level*]		(o)	(o)	(o)	(o)	(o)
Number of mug shelves		4 (with 2 baskets)/ 2 (with 3rd basket)	4 (with 2 baskets)/ 2 (with 3rd basket)	4 (with 2 baskets)/ 2 (with 3rd basket)	4 (with 2 baskets)/ 2 (with 3rd basket)	4 (with 2 baskets)/ 2 (with 3rd basket)
Mug shelves with soft touch rubber		(o)	(o)	(o)	(o)	(o)
Foldable racks on upper basket		(o)	(o)	(o)	(o)	(o)
Foldable racks on lower basket		(o)	(o)	(o)	(o)	(o)

45cm Models INTEGRATED		D42 45cm	D41 45cm	D51 45cm	D52 45cm	D53 45cm
<b>General Characteristics</b>						
Number of place settings (PS)	10 PS (2 baskets)	Default	Default	Default	Default	Default
	10 PS (2 baskets + 3rd rack)	(o) with Turbo fan	(o)	(o) with Aquazone and Turbo fan	(o) with Turbo fan	(o)
	11 PS (2 baskets + 3rd rack)	-	-	-	-	(o)
Number of programmes		8+	8+	6	8+	8+
Temperatures (°C)		Auto-30-40-50-60-65-70	Auto-30-40-50-60-65-70	30-40-50-60-65	Auto-30-40-50-60-65-70	Auto-30-40-50-60-65-70
Control type	Default	Button Control	Button Control	Touch Control	Touch Control	Touch Control
	Option	-	-	-	-	-
Hidden heating element		Yes	Yes	Yes	Yes	Yes
Filter type	Metal	Default	Default	Default	Default	Default
	Plastic	-	-	-	-	-
Tub material		Stainless Steel	Stainless Steel	Stainless Steel	Stainless Steel	Stainless Steel
Turbidity sensor (Smart Wash)		Yes	Yes	(o)	Yes	Yes
Drying system	Mini Active	Default	-	Default	Default	-
	Super Active	(o)	-	(o)	(o)	-
	Turbo	(o)	Default	(o)	(o)	Default
Electrical Diverter system		Yes	Yes	-	Yes	Yes
Overflow & leakage protection		Yes	Yes	Yes	Yes	Yes
Heater protection		Yes	Yes	Yes	Yes	Yes
Circulation pump	Asynchronous	Yes	Yes	Yes	Yes	-
	BLDC	-	-	-	-	Yes
Aquazone		-	-	(o)	-	-
Sliding Door		(o)	(o)	(o)	(o)	(o)
Ion Tech*		(o)	(o)	(o)	(o)	(o)
InfoLED	1,0	(o)	(o)	(o)	(o)	(o)
	2,0 (Floor Indicator)	-	-	-	-	-
Interior light	one spot	(o)	(o)	-	(o)	(o)
	four spot *	(o)	(o)	-	(o)	(o)
Available Aesthetics	Freestanding	-	-	-	-	-
	Semi-Integrated	-	-	-	-	-
	Fully Integrated	Alinda, Spero	Alinda, Spero	Hemen, Hemen (Inox look)	Hemen, Hemen (Inox look)	Hemen, Hemen (Inox look)
<b>Programmes</b>						
Prewash		Yes	Yes	-	-	-
Mini 14' (Jet Wash)		-	-	Yes	Yes	Yes
Quick 30' 40°C		Yes	Yes	Yes	Yes	Yes
Eco (Standard Programme)		Yes	Yes	Yes	Yes	Yes
Super 50' 65°C (Quick Clean)		Yes	Yes	Yes	Yes	Yes
Hygiene 70°C		Yes	Yes	Yes	Yes	Yes
Intensive 65°C		-	-	Yes	-	-
Auto**		-	-	(o)	-	-
Auto Delicate 30°C - 50°C		Yes	Yes	-	Yes	Yes
Auto Normal 50°C - 60°C / Auto Flex 50°C - 60°C		Yes	Yes	-	Yes	-
Auto Intensive 60°C - 70°C		Yes	Yes	-	Yes	Yes (50°C-70°C)
DISPLAY TYPE (delay start, remaining time)		LED Hidden display	LED Hidden display	LED Hidden display	LED Hidden display	LED Hidden display
Display Color	Default	Red	Red	Blue	Blue	Blue
	Option	-	-	White	White	White
Programme selection button		Yes	Yes	Yes	Yes	Yes
Delay timer option	3hr,6hr,9hr	-	-	-	-	-
	1-2-3-...-19hr	Yes	Yes	Yes	Yes	Yes
	1-2-3-...-24hr	-	-	-	-	-
Eco Wash - Half load option	1 mode	-	-	Yes	-	-
	3 modes	Yes	Yes	-	Yes	Yes
Tablet option		Yes	Yes	Yes	Yes	Yes
Extra Rinse option		-	-	-	Yes	-
Extra Silent option (Silent Wash)		-	-	-	-	Yes
Extra Fast option		-	-	-	-	Yes
Energy Save option		-	-	-	-	Yes
Rinse-aid indicator		Yes	Yes	Yes	Yes	Yes
Salt indicator		Yes	Yes	Yes	Yes	Yes
End of cycle indicator		Yes	Yes	-	-	-
Buzzer		Yes	Yes	Yes	Yes	Yes
<b>Baskets &amp; Accessories</b>						
3rd basket (EasyTray) (1)	10 PS	(o)	(o)	(o)	(o)	(o)
Upper basket type		Peg	Peg	Peg	Peg	Peg
Adjustable upper basket [empty/ loaded 2 level / loaded 3 level*]		(o)	(o)	(o)	(o)	(o)
Number of mug shelves		4 (with 2 baskets)/ 2 (with 3rd basket)	4 (with 2 baskets)/ 2 (with 3rd basket)	4 (with 2 baskets)/ 2 (with 3rd basket)	4 (with 2 baskets)/ 2 (with 3rd basket)	4 (with 2 baskets)/ 2 (with 3rd basket)
Mug shelves with soft touch rubber		(o)	(o)	(o)	(o)	(o)
Foldable racks on upper basket		(o)	(o)	(o)	(o)	(o)
Foldable racks on lower basket		(o)	(o)	(o)	(o)	(o)
Upper basket handle type [No / Plastic / Metal]		(o)	(o)	(o)	(o)	(o)

45cm Models INTEGRATED		D12 45cm	D21 45cm	Z21 45cm	D22 45cm	D32 45cm
<b>Baskets &amp; Accessories</b>						
Upper basket handle type [No / Plastic / Metal]		(o)	(o)	(o)	(o)	(o)
Lower basket handle type [No / Plastic / Metal]		(o)	(o)	(o)	(o)	(o)
Removable cutlery basket (Universal)		Yes	Yes	Yes	Yes	Yes
Wine glass holder on lower basket		(o) with foldable racks	(o) with foldable racks	(o) with foldable racks	(o) with foldable racks	(o) with foldable racks
Top nozzle	fixed type with 2 baskets	Default with 2 baskets	Default with 2 baskets	Default with 2 baskets	Default with 2 baskets	Default with 2 baskets
	rotating type	Default with 3rd basket	Default with 3rd basket	Default with 3rd basket	Default with 3rd basket	Default with 3rd basket
AquaStop external hose		(o)	(o)	(o)	(o)	(o)
Antibacterial filter		(o)	(o)	(o)	(o)	(o)
<b>Technical Data (2)</b>						
Sound level (dB(A) re 1 pW)	10 PS	57 / 54 / 52 / 49 / 47 / 45	57 / 54 / 52 / 49 / 47 / 45	57 / 54 / 52 / 49 / 47 / 45	57 / 54 / 52 / 49 / 47 / 45	57 / 54 / 52 / 49 / 47 / 45
Energy efficiency class		A++	A++	A++	A++	A++
Energy efficiency index	10 PS	55,9	55,9	55,8	55,8	55,8
Cleaning efficiency class		A	A	A	A	A
Cleaning efficiency index		1,13	1,13	1,13	1,13	1,13
Drying efficiency class		A	A	A	A	A
Drying efficiency index		1,09	1,09	1,09	1,09	1,09
Standard programme water consumption (lt / cycle)	Default	11,0	11,0	11,0	11,0	11,0
	with Aquazone	9,0	9,0	9,0	9,0	9,0
Annual water consumption (lt / year)	Default	3080	3080	3080	3080	3080
	with Aquazone	2520	2520	2520	2520	2520
Duration of the standard programme (min)	Default	198	198	198	198	198
	with Aquazone	222	222	222	222	222
Standard programme energy consumption (kWh / cycle)	10 PS	0,734	0,734	0,732	0,732	0,732
Annual energy consumption (kWh/ year)	10 PS	211	211	211	211	211
Off mode power consumption (W)		0,50	0,50	0,50	0,50	0,50
Left-on mode power consumption (W)		1,00	1,00	1,00	1,00	1,00
Network standby mode power consumption (W)		N/A	N/A	N/A	N/A	N/A
Duration of left-on mode (min)		N/A	N/A	N/A	N/A	N/A
Power rating (W) / Heating element (W)		1900 / 1800	1900 / 1800	1900 / 1800	1900 / 1800	1900 / 1800
Plug Type		EU / UK / Swiss / Italy / Israel / AU/NZ / China / Argentina / S.Africa	EU / UK / Swiss / Italy / Israel / AU/NZ / China / Argentina / S.Africa	EU / UK / Swiss / Italy / Israel / AU/NZ / China / Argentina / S.Africa	EU / UK / Swiss / Italy / Israel / AU/NZ / China / Argentina / S.Africa	EU / UK / Swiss / Italy / Israel / AU/NZ / China / Argentina / S.Africa
Power cord length (cm)		165	165	165	165	165
Water inlet hose length (cm)	Default	147	147	147	147	147
	with AquaStop ext. hose	170	170	170	170	170
Water outlet hose length (cm)		200	200	200	200	200
Voltage (V) / Frequency (Hz) / Fuse Rating (A)		220-240 / 50 / 10	220-240 / 50 / 10	220-240 / 50 / 10	220-240 / 50 / 10	220-240 / 50 / 10
Water pressure range (bar)		0,3 - 10	0,3 - 10	0,3 - 10	0,3 - 10	0,3 - 10
<b>Dimensions</b>						
Height (cm)	Freestanding	-	-	-	-	-
	Semi-Integrated	-	-	-	-	-
	Fully Integrated	82,0	82,0	82,0	82,0	82,0
Width (cm)		44,8	44,8	44,8	44,8	44,8
Depth (cm)	Freestanding	-	-	-	-	-
	Semi-Integrated	-	-	-	-	-
	Fully Integrated	55,0	55,0	55,0	55,0	55,0
Height adjustment (+cm)	Freestanding	-	-	-	-	-
	Semi-Integrated	-	-	-	-	-
	Fully Integrated	5	5	5	5	5
Decorative panel height (max) (cm) Fully-Integrated		59,7	59,7	59,7	59,7	59,7
Plinth height (min) (cm) Fully-Integrated		8	8	8	8	8
Plinth depth (cm) Fully-Integrated		3 - 8	3 - 8	3 - 8	3 - 8	3 - 8
Packed dimensions (Width x Depth x Height) (cm)	Freestanding	-	-	-	-	-
	Semi-Integrated	-	-	-	-	-
	Fully Integrated	49.4 x 66.1 x 86.1	49.4 x 66.1 x 86.1	49.4 x 66.1 x 86.1	49.4 x 66.1 x 86.1	49.4 x 66.1 x 86.1
Stacking quantity (pcs)	Freestanding	-	-	-	-	-
	Semi-Integrated	-	-	-	-	-
	Fully Integrated	6	6	6	6	6
Gross/Net weight (kg)(3)	Freestanding	-	-	-	-	-
	Semi-Integrated	-	-	-	-	-
	Fully Integrated	34 / 32	34 / 32	34 / 32	34 / 32	34 / 32
Container loading (40"HC/ 40"/ 20")		216 or 251 /144 /72	216 or 251 /144 /72	216 or 251 /144 /72	216 or 251 /144 /72	216 or 251 /144 /72
<b>Sliding Door Dimensions</b>						
Sliding range (cm)		4 or 8	4 or 8	4 or 8	4 or 8	4 or 8
Decorative panel height (max) (cm)		75.7 or 79.7	75.7 or 79.7	75.7 or 79.7	75.7 or 79.7	75.7 or 79.7
Plinth height (min) (cm)		2 or 6	2 or 6	2 or 6	2 or 6	2 or 6
Plinth depth (cm)		0 - 8	0 - 8	0 - 8	0 - 8	0 - 8

45cm Models INTEGRATED		D42 45cm	D41 45cm	D51 45cm	D52 45cm	D53 45cm
<b>Baskets &amp; Accessories</b>						
Lower basket handle type [No / Plastic / Metal]		(o)	(o)	(o)	(o)	(o)
Removable cutlery basket (Universal)		Yes	(Yes) with 2 baskets/ (o) with 3rd basket	Yes	(Yes) with 2 baskets/ (o) with 3rd basket	(Yes) with 2 baskets/ (o) with 3rd basket
Wine glass holder on lower basket		(o) with foldable racks	(o) with foldable racks	(o) with foldable racks	(o) with foldable racks	(o) with foldable racks
Top nozzle	fixed type with 2 baskets	Default with 2 baskets	Default with 2 baskets	Default with 2 baskets	Default with 2 baskets	Default with 2 baskets
	rotating type	Default with 3rd basket	Default with 3rd basket	Default with 3rd basket	Default with 3rd basket	Default with 3rd basket
AquaStop external hose		(o)	(o)	(o)	(o)	(o)
Antibacterial filter		(o)	(o)	(o)	(o)	(o)
<b>Technical Data (2)</b>						
Sound level (dB(A) re 1 pW)	10 PS	57 / 54 / 52 / 49 / 47 / 45	52 / 49 / 47 / 45	57 / 54 / 52 / 49 / 47 / 45	57 / 54 / 52 / 49 / 47 / 45	44
Energy efficiency class		A++	A++	A++	A++	A+++
Energy efficiency index	10 PS	55,8	55,8	55,8	55,8	49,7
Cleaning efficiency class		A	A	A	A	A
Cleaning efficiency index		1,13	1,13	1,13	1,13	1,13
Drying efficiency class		A	A	A	A	A
Drying efficiency index		1,09	1,09	1,09	1,09	1,09
Standard programme water consumption (lt / cycle)	Default	9,0	9,0	11,0	9,0	9,0
	with Aquazone	-	-	9,0	-	-
Annual water consumption (lt / year)	Default	2520	2520	3080	2520	2520
	with Aquazone	-	-	2520	-	-
Duration of the standard programme (min)	Default	198	198	198	198	185
	with Aquazone	-	-	222	-	-
Standard programme energy consumption (kWh / cycle)	10 PS	0,732	0,732	0,732	0,732	0,650
Annual energy consumption (kWh/ year)	10 PS	211	211	211	211	188
Off mode power consumption (W)		0,50	0,50	0,50	0,50	0,50
Left-on mode power consumption (W)		1,00	1,00	1,00	1,00	1,00
Network standby mode power consumption (W)		N/A	N/A	N/A	N/A	N/A
Duration of left-on mode (min)		N/A	N/A	N/A	N/A	N/A
Power rating (W) / Heating element (W)		1900 / 1800	1900 / 1800	1900 / 1800	1900 / 1800	1900 / 1800
Plug Type		EU / UK / Swiss / Italy / Israel / AU/NZ / China / Argentina / S.Africa	EU / UK / Swiss / Italy / Israel / AU/NZ / China / Argentina / S.Africa	EU / UK / Swiss / Italy / Israel / AU/NZ / China / Argentina / S.Africa	EU / UK / Swiss / Italy / Israel / AU/NZ / China / Argentina / S.Africa	EU / UK / Swiss / Italy / Israel / AU/NZ / China / Argentina / S.Africa
Power cord length (cm)		165	165	165	165	165
Water inlet hose length (cm)	Default	147	147	147	147	147
	with AquaStop ext. hose	170	170	170	170	170
Water outlet hose length (cm)		200	200	200	200	200
Voltage (V) / Frequency (Hz) / Fuse Rating (A)		220-240 / 50 / 10	220-240 / 50 / 10	220-240 / 50 / 10	220-240 / 50 / 10	220-240 / 50 / 10
Water pressure range (bar)		0,3 - 10	0,3 - 10	0,3 - 10	0,3 - 10	0,3 - 10
<b>Dimensions</b>						
Height (cm)	Freestanding	-	-	-	-	-
	Semi-Integrated	-	-	-	-	-
	Fully Integrated	82,0	82,0	82,0	82,0	82,0
Width (cm)		44,8	44,8	44,8	44,8	44,8
Depth (cm)	Freestanding	-	-	-	-	-
	Semi-Integrated	-	-	-	-	-
	Fully Integrated	55,0	55,0	55,0	55,0	55,0
Height adjustment (+cm)	Freestanding	-	-	-	-	-
	Semi-Integrated	-	-	-	-	-
	Fully Integrated	5	5	5	5	5
Decorative panel height (max) (cm) Fully-Integrated		59,7	59,7	59,7	59,7	59,7
Plinth height (min) (cm) Fully-Integrated		8	8	8	8	8
Plinth depth (cm) Fully-Integrated		3 - 8	3 - 8	3 - 8	3 - 8	3 - 8
Packed dimensions (Width x Depth x Height) (cm)	Freestanding	-	-	-	-	-
	Semi-Integrated	-	-	-	-	-
	Fully Integrated	49.4 x 66.1 x 86.1	49.4 x 66.1 x 86.1	49.4 x 66.1 x 86.1	49.4 x 66.1 x 86.1	49.4 x 66.1 x 86.1
Stacking quantity (pcs)	Freestanding	-	-	-	-	-
	Semi-Integrated	-	-	-	-	-
	Fully Integrated	6	6	6	6	6
Gross/Net weight (kg)(3)	Freestanding	-	-	-	-	-
	Semi-Integrated	-	-	-	-	-
	Fully Integrated	34 /32	34 /32	34 /32	34 /32	34 /32
Container loading (40"HC/ 40"/ 20")		216 or 251 /144 /72	216 or 251 /144 /72	216 or 251 /144 /72	216 or 251 /144 /72	216 or 251 /144 /72
<b>Sliding Door Dimensions</b>						
Sliding range (cm)		4 or 8	4 or 8	4 or 8	4 or 8	4 or 8
Decorative panel height (max) (cm)		75.7 or 79.7	75.7 or 79.7	75.7 or 79.7	75.7 or 79.7	75.7 or 79.7
Plinth height (min) (cm)		2 or 6	2 or 6	2 or 6	2 or 6	2 or 6
Plinth depth (cm)		0 - 8	0 - 8	0 - 8	0 - 8	0 - 8

Notes

(o) : Optional

(\*) : See roadmap for availability

(\*\*) : Auto programme can be chosen instead of Intensive programme (with turbidity sensor).

(1) : Turbo Fan feature & Aquazone or Electrical Diverter system are default for 3rd basket models.

(2) : Based on the tests performed with Eco programme in accordance with European Household Dishwasher Performance Standards

(3) : Gross/Net Weights are shown as reference in the table. It should be calculated based on the final product features created from this general spect table.



Z Series (Top control) 45 cm Models		ZA5	ZB7	ZA5 BLDC*	ZB7 BLDC*
<b>General Characteristics</b>					
<b>Number of place settings (PS)</b>		Standard	Standard	Standard	Standard
<b>Number of programmes</b>		6	8	6	8
<b>Control type</b>	Default	Button Control	Button Control	Button Control	Button Control
	Option	Touch Control (1)	Touch Control (1)	Touch Control (1)	Touch Control (1)
<b>Hidden heating element</b>		Yes	Yes	Yes	Yes
<b>Filter type</b>	Metal	Default	Default	Default	Default
	Plastic	-	-	-	-
<b>Tub material</b>		Stainless Steel	Stainless Steel	Stainless Steel	Stainless Steel
<b>Tub Type [Tall Tub/ Normal Tub]</b>		Normal Tub	Normal Tub	Normal Tub	Normal Tub
<b>Turbidity sensor (Smart Wash)</b>		Yes	Yes	Yes	Yes
<b>Drying system</b>	Mini Active	Default	Default	Default	Default
	Super Active	(o)	(o)	(o)	(o)
	Turbo	(o)	(o)	(o)	(o)
<b>Electrical Diverter system</b>		-	Yes	-	Yes
<b>Water Regeneration system</b>		(o)	(o)	(o)	(o)
<b>Overflow &amp; leakage protection</b>		Yes	Yes	Yes	Yes
<b>Heater protection</b>		Yes	Yes	Yes	Yes
<b>Circulation pump</b>	Asynchronous	Asynchronous	Asynchronous	-	-
	BLDC	-	-	BLDC	BLDC
<b>Available Aesthetics</b>	Front Control	-	-	-	-
	Top Control	-	-	-	-
	Integrated	Spero	Spero	Spero	Spero
<b>Appliance Color Options for Anjer Aesthetic</b>		Black, White, Inox	Black, White, Inox	Black, White, Inox	Black, White, Inox
<b>Programmes</b>					
<b>P1. Regular</b>		Yes	Yes	Yes	Yes
<b>P2. Intensive</b>		Yes	Yes	Yes	Yes
<b>P3. Super</b>		Yes	Yes	Yes	Yes
<b>P4. Auto</b>		Yes	Yes	Yes	Yes
<b>P5. Rinse</b>		Yes	Yes	Yes	Yes
<b>P6. Delicate</b>		Yes	Yes	Yes	Yes
<b>P7. Daily</b>		-	Yes	-	Yes
<b>P8. Intensive Plus</b>		-	Yes	-	Yes
<b>User Interface</b>					
<b>Start/Pause button</b>		Yes	Yes	Yes	Yes
<b>DISPLAY (delay start, remaining time)</b>		Yes: LED	Yes: LED	Yes: LED	Yes: LED
<b>Display Color</b>	Default	Red	Red	Red	Red
	Option	-	-	-	-
<b>Prewash button</b>		-	-	-	-
<b>Programme selection button</b>		Yes	Yes	Yes	Yes
<b>Delay timer option</b>	3hr,6hr,9hr	-	-	-	-
	1-2-3-...-19hr	Yes (1-2-3-...-19hr)	Yes (1-2-3-...-19hr)	Yes (1-2-3-...-19hr)	Yes (1-2-3-...-19hr)
	1-2-3-...-24hr	-	-	-	-
<b>Eco Wash - Half load option</b>	1 mode	Yes	-	Yes	-
	3 modes	-	Yes	-	Yes
<b>Hi-Temp option</b>		Yes	Yes	Yes	Yes
<b>Sanitize option</b>		Yes	Yes	Yes	Yes
<b>Extra Rinse option</b>		Yes	Yes	-	-
<b>Extra Drying option</b>		Yes	Yes	-	-
<b>Extra Silent</b>		-	-	Yes	Yes
<b>Extra Fast</b>		-	-	Yes	Yes
<b>Rinse-aid indicator</b>		Yes	Yes	Yes	Yes
<b>Salt indicator or Power on indicator</b>		Yes	Yes	Yes	Yes
<b>Washing cycle indicators</b>		-	-	-	-
<b>End of cycle indicator</b>		Yes	Yes	Yes	Yes
<b>Child Lock</b>		-	-	-	-
<b>Buzzer</b>		Yes	Yes	Yes	Yes

Z Series (Top control) 45 cm Models		ZA5	ZB7	ZA5 BLDC*	ZB7 BLDC*
<b>Baskets &amp; Accessories</b>					
3rd basket [EasyTray, EcoTray or Flex Tray]		-	(o)	-	(o)
Upper basket type		Peg Type	Peg Type	Peg Type	Peg Type
Adjustable upper basket [empty/ loaded 2 level / loaded 3 level]		(o)	(o)	(o)	(o)
Number of mug shelves		2 (std) / 4 (o)	2 (std) / 4 (o)	2 (std) / 4 (o)	2 (std) / 4 (o)
Adjustable mug shelves		Yes	Yes	Yes	Yes
Mug shelves with soft touch rubber		(o)	(o)	(o)	(o)
Foldable racks on upper basket		fixed (std) / 2 or 4 or 6 (o)	fixed (std) / 2 or 4 or 6 (o)	fixed (std) / 2 or 4 or 6 (o)	fixed (std) / 2 or 4 or 6 (o)
Foldable racks on lower basket		(o)	(o)	(o)	(o)
Removable cutlery basket		Yes	Yes	Yes	Yes
Multi functional kit (Extra mug shelves + higher rear part on lower basket)		(o)	(o)	(o)	(o)
Bottle holder on lower basket		(o)	(o)	(o)	(o)
Wine glass holder on lower basket		(o)	(o)	(o)	(o)
Top nozzle	fixed type with 2 baskets	Default with 2 baskets	Default with 2 baskets	Default with 2 baskets	Default with 2 baskets
	rotating type	-	Default with 3rd basket	-	Default with 3rd basket

## SPECIFICATIONS

*Hobs and Ovens*



60cm BUILT-IN OVEN SPECIFICATION SHEET		Electric	Pyrolytic	Electric Polyvalente
<b>Dimensions</b>				
Product Height	mm	595	595	595
Product Width	mm	595	595	595
Product Depth (with / without Control Panel)	mm	575 / 550	575 / 550	575 / 550
Cabinet Dimensions (Width / Height / Depth) -If control panel located inside the cabinet	mm	600 / 600 / 590	600 / 600 / 590	600 / 600 / 590
Cabinet Dimensions (Width / Height / Depth) -If control panel not located inside the cabinet	mm	min.560 max.580 / min.600 / min.555	min.560 max.580 / min.600 / min.555	min.560 max.580 / min.600 / min.555
<b>Oven Features</b>				
Oven Type		Electric	Electric (Pyrolytic)	Electric
Oven Volume (without/with fan)	lt	61 / 56 - 72 / 65	56 (old platform) 65 (new platform)	61 / 56 - 72 / 65
Cavity Dimensions (without/with fan)	mm	430 x 429 x 335 / 430 x 391 x 335 - 450 x 451 x 352 / 450 x 413x 352	430 x 391 x 335 (old platform) 450 x 404 x 352 (new platform)	430 x 429 x 335 / 430 x 391 x 335 - 450 x 451 x 352 / 450 x 413x 352
Volume Old Platform (without/with fan)	lt	64 / 58 (mold runners) - 67 / 61 (wire rack)	-	64 / 58 (mold runners) - 67 / 61 (wire rack)
Volume New Platform (without/with fan)	lt	72 / 65 (mold runners) - 76 / 69 (wire rack)	65 (mold runners) - 69 (wire rack)	72 / 65 (mold runners) - 76 / 69 (wire rack)
Cavity Dimensions Molded Old Platform (without/with fan) (Width / Height / Depth)	mm	430 x 335 x 441 / 430 x 335 x 402	-	430 x 335 x 441 / 430 x 335 x 402
Cavity Dimensions Wire Rack Old Platform (without/with fan) (Width / Height / Depth)	mm	455 x 335 x 441 / 455 x 335 x 402	-	455 x 335 x 441 / 455 x 335 x 402
Cavity Dimensions Molded New Platform (without/with fan) (Width / Height / Depth)	mm	450 x 352 x 452 / 450 x 352 x 413	450 x 352 x 403 (Type 3 Pyrolytic Oven Door) 450 x 352 x 413 (Type 5 Active Cool Oven Door) Only with fan	450 x 352 x 452 / 450 x 352 x 413
Cavity Dimensions Wire Rack New Platform (without/with fan) (Width / Height / Depth)	mm	475 x 352 x 452 / 475 x 352 x 413	475 x 352 x 403 (Type 3 Pyrolytic Oven Door) 475 x 352 x 413 (Type 5 Active Cool Oven Door) Only with fan	475 x 352 x 452 / 475 x 352 x 413
Oven Light (25W)		Standard	Standard	Standard
Pyrolytic Enamel			Standard	
Wire Side Racks		Optional	Optional	Optional
Telescopic Rails (1 or 2 racks)		Optional	Optional	Optional
Top Heating Element	W	1200	1200	1200
Bottom Heating Element	W	1100	1100	1100
Thermostat		Standard	Electronic	Standard
Grill (Thermostatic)	W	1400	1400	1400
Double Grill (Thermostatic)	W	2600	2600	2600
Fan	W	23	23	23
Fan with Ring Heating Element	W	2000	2000	2000
Automatic Boost Function		available for some control unit	available for some control unit	available for some control unit
Turnspit		Optional	Optional	Optional
Oven Functions		Up to 9	Up to 7	Up to 9
Thermostat Operation Indicator Light		Standard	Standard	Standard
Oven Operation Indicator Light		Standard	-	-
Hotplate Operation Indicator Light (in case of polyvalente oven)		-	-	Standard
Oven Door lock indicator light		-	Standard	-
Minute Minder		Optional	-	Optional
Mechanical Timer		Optional	-	Optional
Analog Timer		Optional	-	Optional
Digital Clock		Optional	-	Optional
Digital Programmer		Optional	Standard	Optional
Digital Programmer with touch interface		Optional	-	Optional
Full Touch LED Display		Optional	Optional	Optional
Knob Control LED Display and Touch Interface (Visio Touch)		Optional	Optional	-
Knob Control LED Display (Visio Display)		Optional	-	-
Smart LCD (Ready Cook)		Optional	-	-
Monochrome LCD		Optional	-	-
Baking Tray (Shallow Tray)		Optional	1	Optional
Roasting Tray (Deep Tray)		1	Optional	1
Chromed Grid with Stoper		1	1	1
Wire grid for deep tray		Optional	Optional	Optional
Grill Pan with Handle Set		Optional	Optional	Optional
Self Cleaning Period	hours	-	1, 5 / 1	-
Energy Consumption during Self Cleaning Function	kwh	-	2, 6	-
<b>Available Colours</b>				
White		Standard	Standard	Standard
Black		Optional	Optional	Optional
Stainless Steel		Optional	Optional	Optional
Terre De France		Optional	Optional	Optional
Mink		Optional	Optional	Optional
Claret Red		Optional	Optional	Optional
Cream		Optional	Optional	Optional
Rustik (Black / White / Cream)		Optional	Optional	Optional
Silver		Optional	Optional	Optional
<b>Control Panel</b>				
Metal		Standard	Standard	Standard
Glass		Optional	Optional	Optional
Various Types of Inox Add-on on Glass Control Panel		Optional	Optional	Optional
<b>Oven Door</b>				
Full outer glass and small inner glass with metal frame (4 glasses)		-	Standard	-
Full inner glass and full glass front face (4 glasses) Oven Door		-	Optional	-
Full outer glass and inner glass Oven Door		Standard	-	Optional
Full outer glass and full inner glass Oven Door		Optional	-	Optional
Cool touch Oven door		Optional	-	Optional
Mirror Oven Door Glass		Optional	-	Optional
Removable Oven Door		Standard	Standard	Standard
Various Types of Inox Add-on on Oven Door Glass		Optional	Optional	Optional
Child Lock on Oven Door		Optional	Standard (Electromechanic)	Optional
<b>Others</b>				
Total Power (Depends on Model) Maximum	kW	3, 1	2, 6	3, 1
Tangential Cooling Fan (in case of built-in oven with cooling fan)	W	11, 5	23 / 40 (double level)	11, 5
Tangential Cooling Fan Noise Level	dB(A)	49	53 (for pyrolytic function) 49 (for cooking function)	49
Voltage	V	230	230	230
Electric Cooker Energy Rating (Depends on Model)		A++ / A+ / A	A	A
Cavity Insulation		White / Yellow	White (with Aluminum foil)	White / Yellow
Pop-in / Pop-out Knob		Optional	Optional	Optional
Hob controls on Control Panel (in case of polyvalente oven)		Standard	-	Standard
Main Cable		Standard	Standard	Standard
Shrink Packed Product Dimensions (Width / Depth / Height)	mm	650 x 640 x 650	650 x 640 x 650	650 x 640 x 650
Carton Box Packaging		Optional	Optional	Optional
RoHS Compliance		Standard	Standard	Standard
CE Compliance		Standard	Standard	Standard
Net Weight (Depends on Model) Maximum	kg	35	34	35
Gross Weight (Depends on Model) Maximum	kg	37.7	36.2	37.7
Container Loading Quantity (20 Ft Container)	pcs	81	81	81
Container Loading Quantity (40 Ft Container)	pcs	162	162	162
Container Loading Quantity (40 Ft HC Container)	pcs	216	216	216



60cm BUILT-IN OVEN SPECIFICATION SHEET		Electric (75L)	Electric Polyvalente (75L)
<b>Dimensions</b>			
Product Height	mm	595	595
Product Width	mm	595	595
Product Depth (with / without Control Panel)	mm	575 / 550	575 / 550
Cabinet Dimensions (Width / Height / Depth) -If control panel located inside the cabinet	mm	600 / 600 / 590	600 / 600 / 580
Cabinet Dimensions (Width / Height / Depth) -If control panel not located inside the cabinet	mm	560 / 590 / 555	560 / 580 / 555
<b>Oven Features</b>			
Oven Type		Electric	Electric
Oven Volume (without/with fan)	lt	80 / 73(mold runners) - 85 / 78(wire rack)	80 / 73(mold runners) - 85 / 78(wire rack)
Cavity Dimensions (without/with fan)	mm	450 x 451 x 392 / 450 x 413x 392	450 x 451 x 392 / 450 x 413x 392
Oven Light (25W)		Standard	Standard
Easy to Clean Enamel		Standard	Standard
Catalytic Enamel Panels (Left, right and rear)		Optional	Optional
Wire Side Racks		Optional	Optional
Telescopic Rails (1 or 2 racks)		Optional	Optional
Top Heating Element	W	1200	1200
Bottom Heating Element	W	1100	1100
Thermostat		Standard	Standard
Grill (Thermostatic)	W	1400	1400
Double Grill (Thermostatic)	W	2600	2600
Fan	W	23	23
Fan with Ring Heating Element	W	2000	2000
Automatic Boost Function		available for some control unit	available for some control unit
Turnspit		Optional	Optional
Oven Functions		Up to 9	Up to 9
Thermostat Operation Indicator Light		Standard	Standard
Oven Operation Indicator Light		Standard	-
Hotplate Operation Indicator Light (in case of polyvalente oven)		-	Standard
Minute Minder		Optional	Optional
Mechanical Timer		Optional	Optional
Digital Clock		Optional	Optional
Digital Programmer		Optional	Optional
Digital Programmer with touch interface		Optional	Optional
Knob Control LED Display and Touch Interface (Visio Touch)		Optional	-
Knob Control LED Display (Visio Display)		Optional	-
Smart LCD (Ready Cook)		Optional	-
Monochrome LCD		Optional	-
Baking Tray (Shallow Tray)		Optional	Optional
Roasting Tray (Deep Tray)		1	1
Chromed Grid with Stoper		1	1
Wire grid for deep tray		Optional	Optional
Grill Pan with Handle Set		Optional	Optional
<b>Available Colours</b>			
White		Standard	Standard
Black		Optional	Optional
Stainless Steel		Optional	Optional
Terre De France		Optional	Optional
Mink		Optional	Optional
Claret Red		Optional	Optional
Cream		Optional	Optional
Rustik (Black / White / Cream)		Optional	Optional
Silver		Optional	Optional
<b>Control Panel</b>			
Metal		Standard	Standard
Glass		Optional	Optional
Various Types of Inox Add-on on Glass Control Panel		Optional	Optional
<b>Oven Door</b>			
Full outer glass and full inner glass Oven Door		Standard	Standard
Mirror Oven Door Glass		Optional	Optional
Removable Oven Door		Standard	Standard
Various Types of Inox Add-on on Oven Door Glass		Optional	Optional
<b>Others</b>			
Total Power (Depends on Model) Maximum	kW		
Tangential Cooling Fan (in case of built-in oven with cooling fan)	W	11, 5	11, 5
Tangential Cooling Fan Noise Level	dBA	49	49
Voltage	V	230	230
Electric Cooker Energy Rating (Depends on Model)		A+ / A	A
Cavity Insulation		White / Yellow	White / Yellow
Pop-in / Pop-out Knob		Optional	Optional
Hob controls on Control Panel (in case of combi oven)		Standard	Standard
Main Cable		Standard	Standard
Shrink Packed Product Dimensions (Width / Depth / Height)	mm	680 x 630 x 640	680 x 630 x 640
Carton Box Packaging		Optional	Optional
RoHS Compliance		Standard	Standard
CE Compliance		Standard	Standard
Net Weight (Depends on Model) Maximum	kg	36	36
Gross Weight (Depends on Model) Maximum	kg	38, 2	38, 2
Container Loading Quantity (20 ft Container)	pcs	81	81
Container Loading Quantity (40 ft Container)	pcs	162	162
Container Loading Quantity (40 ft HC Container)	pcs	216	216

BUILT-IN / TABLE-TOP HOB SPECIFICATION SHEET	BI Gas/Combined Hobs								
	60 CM	60 CM	60 CM	60 CM	60 CM	60 CM	70 CM	70 CM	
	Flat / Surface	Extenda	Classic	Model I	PlusX	Division	Model I	PlusX	
<b>Available Colours</b>									
White		Standard	Standard	Standard	Standard	Standard	-	Standard	Standard
Brown		Optional	Optional	Optional	Optional	Optional	-	Optional	Optional
Terre de France		Optional	Optional	Optional	Optional	Optional	-	Optional	Optional
Black		Optional	Optional	Optional	Optional	Optional	-	Optional	Optional
Dark Green		Optional	Optional	Optional	Optional	Optional	-	Optional	Optional
Stainless Steel		Optional	Optional	Optional	Optional	Optional	Standard	Optional	Optional
<b>Product Dimensions</b>									
Height (max., varies from model to model)	mm	40	40	40	39, 5	42	42	39, 5	42
Width	mm	580	580	580	590	580	580	680	700
Depth (max., do not include gas connection detail)	mm	510	510	510	515	515	510	515	515
<b>Cut-out Dimensions</b>									
Width	mm	560	560	560	560	560	560	560	560
Depth	mm	490	490	490	490	490	490	490	490
<b>Hob Features</b>									
Hob		Enamel / Stainless Steel	Enamel / Stainless Steel	Enamel / Stainless Steel	Enamel / Stainless Steel	Enamel / Stainless Steel	Stainless Steel	Enamel / Stainless Steel	Enamel / Stainless Steel
Rapid Gas Burner Ø10cm	W	3000	3000	3000	3000	3000	3000	3000	3000
Semi-rapid Gas Burner Ø7.5cm	W	1750	1750	1750	1750	1750	1750	1750	1750
Auxiliary Gas Burner Ø5.5cm	W	1000	1000	1000	1000	1000	1000	1000	1000
Wok (Triple Flame) Gas Burner Mono Ø14cm	W	3600	3600	3600	3600	-	-	3600	3600
Wok (Triple Flame) Gas Burner Dual Ø14cm	W	-	-	-	-	-	-	-	-
Wok (Triple Flame) Gas Burner Ø11cm	W	-	-	-	-	3200	-	-	-
Ø 145 mm Hotplate	W	-	-	1000	1000	1000	-	1000	1000
Ø 180 mm Hotplate	W	1500	1500	-	-	-	-	-	-
Ø 145 mm Rapid Hotplate	W	-	-	-	-	-	-	-	-
Ø 180 mm Rapid Hotplate	W	-	-	-	-	-	-	-	-
Ø145 mm Highlight Element	W	-	-	-	-	-	-	-	-
Ø180 mm Highlight Element	W	-	-	-	-	-	-	-	-
Ø210 mm Highlight Element	W	-	-	-	-	-	-	-	-
Ø180 mm Dual Highlight Element	W	-	-	-	-	-	-	-	-
Ø145 mm Oval Highlight Element	W	-	-	-	-	-	-	-	-
Ø210 mm Dual Highlight Element	W	-	-	-	-	-	-	-	-
Ø210 mm Triple Highlight Element	W	-	-	-	-	-	-	-	-
Ø290 mm Dual Highlight Element	W	-	-	-	-	-	-	-	-
Ø 160 mm Induction Zone(Serie 1 and Serie 2)	W	-	-	-	-	-	-	-	-
Ø 200 mm Induction Zone(Serie 1)	W	-	-	-	-	-	-	-	-
Ø 210 mm Induction Zone(Serie 2)	W	-	-	-	-	-	-	-	-
Ø 250 mm Induction Zone(Serie 1)	W	-	-	-	-	-	-	-	-
Ø 290 mm Induction Zone(Serie 2)	W	-	-	-	-	-	-	-	-
Boost Funcion		-	-	-	-	-	-	-	-
Pot Dedection		-	-	-	-	-	-	-	-
Automatic Heatup		-	-	-	-	-	-	-	-
Timer function for vitro ceramic hobs (If touch control with some hob Configuration selected)		-	-	-	-	-	-	-	-
Mode function for induction ceramic hobs (If touch control with some hob Configuration selected)		-	-	-	-	-	-	-	-
Bridge zone for induction ceramic hobs (If touch control with some hob Configuration selected)		-	-	-	-	-	-	-	-
Child Lock for vitro ceramic hobs (If touch control selected)		-	-	-	-	-	-	-	-
Mechanical Child Lock (Main Switch)		-	-	-	-	-	-	-	-
Hot Surface Indicator Light		-	-	-	-	-	-	-	-
Hotplate Operation Indicator Light		Standard	Standard	Standard	Standard	Standard	-	Standard	Standard
Side Knob Control		Standard	Standard	Standard	Standard	-	-	-	-
Front Knob Control		-	-	-	Standard	Standard	-	Standard	Standard
Double Side Front Control		-	-	-	-	-	Standard	-	-
Front Triangular Touch Control		-	-	-	-	-	-	-	-
Front Slider Touch Control		-	-	-	-	-	-	-	-
Front Touch Control		-	-	-	-	-	-	-	-
Bevelled Edges		-	-	-	-	-	-	-	-
Logo		Standard	Standard	Standard	Standard	Standard	Standard	Standard	Standard
Special Decoration on Glass		-	-	-	-	-	-	-	-
Vitroceramic Glass Artwork		-	-	-	-	-	-	-	-
Inox Frame		-	-	-	-	-	-	-	-
Stainless Steel Burner Pan		-	-	-	-	-	-	-	-
Table Top Installation (not built-in)		Optional	Optional	Optional	-	-	-	-	-
Glass Lid		-	-	-	-	-	-	-	-
Burner Safety Valves		Standard	Standard	Standard	Standard	Standard	Standard	Standard	Standard
Button Ignition		Optional	Optional	Optional	Optional	-	-	Optional	-
One-touch-Ignition through knobs		Optional	Optional	Optional	Optional	Optional	Standard	Optional	Optional
Enamel Pan Supports		Standard	Standard	Standard	Standard	Standard	-	Standard	Standard
Cast Iron Pan Supports		Optional	Optional	-	Optional	Optional	Standard	Optional	Optional
Cast Iron Burner Caps		Optional	Optional	-	Optional	Optional	Optional	Optional	Optional
Coffee Adaptor		Optional	Optional	Optional	Optional	Optional	Optional	Optional	Optional
Wok Adaptor		Optional	Optional	Optional	Optional	Optional	-	Optional	Optional
Vitroceramic Glass Cleaning Spatula		-	-	-	-	-	-	-	-
Gas Conversion Kit		Standard	Standard	Standard	Standard	Standard	Standard	Standard	Standard
<b>Others</b>									
Total Gas Power (Depends on Model) Maximum	kW	8,1	8,1	8,1	8,1	7,7	7,5	11,1	11,1
Total Electric Power (Depends on Model) Maximum	kW	1,5	1,5	1	1	1	-	1	1
Voltage	V	230V~	230V~	230V~	230V~	230V~	230V~	230V~	230V~
RoHS Compliance		Standard	Standard	Standard	Standard	Standard	Standard	Standard	Standard
CE Compliance		Standard	Standard	Standard	Standard	Standard	Standard	Standard	Standard
Carton Box Packaging		Standard	Standard	Standard	Standard	Standard	Standard	Standard	Standard
Packed Product Dimensions (WxDxH)	mm	626 x 580 x 140	x	626 x 560 x 130	641 x 576 x 161	x	x	731 x 576 x 161	x
Loading Quantity 20 ft (Wrapped Carton)	pcs	576	x	612	448	x	x	420	x
Loading Quantity 40 ft (Wrapped Carton)	pcs	1216	x	1292	1008	x	x	896	x
Loading Quantity 40 HC (Wrapped Carton)	pcs	1368	x	1444	1152	x	x	1024	x
Packed Product Dimensions (WxDxH) Box	mm	640 x 584 x 152	647 x 582 x 164	635 x 564 x 142	x	647 x 582 x 164	647 x 582 x 164	x	769 x 582 x 164
Loading Quantity 20 ft (Carton Box)	pcs	405	378	576	x	378	378	x	378
Loading Quantity 40 ft (Carton Box)	pcs	900	840	1152	x	840	840	x	840
Loading Quantity 40 HC (Carton Box)	pcs	1020	960	1296	x	960	960	x	960
Net Weight (Depends on Model) Maximum	kg	9	9,5	6,6	9,8	9,5	11	10,7	12,5
Gross Weight (Depends on Model) Maximum	kg	9,75	10,5	7,5	10,6	10,5	12	11,6	13,5

BUILT-IN / TABLE-TOP HOB SPECIFICATION SHEET		BI Gas Securit Hobs							
		60 CM Securit II	60 CM Trio	60 CM Model I	60 CM PlusX	60 CM Division	70 CM Model I	70 CM PlusX	90 CM
<b>Available Colours</b>									
White		Optional	Optional	Optional	Optional	-	Optional	Optional	Optional
Brown		Optional	Optional	Optional	Optional	-	Optional	Optional	Optional
Terre de France		Optional	Optional	Optional	Optional	-	Optional	Optional	Optional
Black		Standard	Standard	Standard	Standard	Standard	Standard	Standard	STANDARD
Dark Green		Optional	Optional	Optional	Optional	-	Optional	Optional	Optional
Stainless Steel		-	-	-	-	-	-	-	-
<b>Product Dimensions</b>									
Height (max., varies from model to model)	mm	44	44	39,5	44	44	39,5	44	47
Width	mm	594	594	590	594	594	680	700	882
Depth (max., do not include gas connection detail)	mm	523	523	515	523	523	515	520	520
<b>Cut-out Dimensions</b>									
Width	mm	560	560	560	560	560	560	560	850
Depth	mm	490	490	490	490	490	490	490	480
<b>Hob Features</b>									
Hob		Securit	Securit	Securit	Securit	Securit	Securit	Securit	Securit
Rapid Gas Burner Ø10cm	W	3000	3000	3000	3000	3000	3000	3000	3000
Semi-rapid Gas Burner Ø7.5cm	W	1750	1750	1750	1750	1750	1750	1750	1750
Auxiliary Gas Burner Ø5.5cm	W	1000	1000	1000	1000	1000	1000	1000	1000
Wok (Triple Flame) Gas Burner Mono Ø14cm	W	3600	3600	3600	3600	-	3600	3600	4500
Wok (Triple Flame) Gas Burner Dual Ø14cm	W	-	-	-	-	-	-	-	4500
Wok (Triple Flame) Gas Burner Ø11cm	W	-	-	-	-	-	-	-	-
Ø 145 mm Hotplate	W	-	-	-	1000	-	-	-	-
Ø 180 mm Hotplate	W	-	-	-	-	-	-	-	-
Ø 145 mm Rapid Hotplate	W	-	-	-	-	-	-	-	-
Ø 180 mm Rapid Hotplate	W	-	-	-	-	-	-	-	-
Ø145 mm Highlight Element	W	-	-	-	-	-	-	-	-
Ø180 mm Highlight Element	W	-	-	-	-	-	-	-	-
Ø210 mm Highlight Element	W	-	-	-	-	-	-	-	-
Ø180 mm Dual Highlight Element	W	-	-	-	-	-	-	-	-
Ø145 mm Oval Highlight Element	W	-	-	-	-	-	-	-	-
Ø210 mm Dual Highlight Element	W	-	-	-	-	-	-	-	-
Ø210 mm Triple Highlight Element	W	-	-	-	-	-	-	-	-
Ø290 mm Dual Highlight Element	W	-	-	-	-	-	-	-	-
Ø 160 mm Induction Zone(Serie 1 and Serie 2)	W	-	-	-	-	-	-	-	-
Ø 200 mm Induction Zone(Serie 1)	W	-	-	-	-	-	-	-	-
Ø 210 mm Induction Zone(Serie 2)	W	-	-	-	-	-	-	-	Standard
Ø 250 mm Induction Zone(Serie 1)	W	-	-	-	-	-	-	-	-
Ø 290 mm Induction Zone(Serie 2)	W	-	-	-	-	-	-	-	-
Boost Funcion		-	-	-	-	-	-	-	-
Pot Dedection		-	-	-	-	-	-	-	-
Automatic Heatup		-	-	-	-	-	-	-	-
Timer function for vitro ceramic hobs (If touch control with some hob Configuration selected)		-	-	-	-	-	-	-	-
Mode function for induction ceramic hobs (If touch control with some hob Configuration selected)		-	-	-	-	-	-	-	-
Bridge zone for induction ceramic hobs (If touch control with some hob Configuration selected)		-	-	-	-	-	-	-	-
Child Lock for vitro ceramic hobs (If touch control selected)		-	-	-	-	-	-	-	-
Mechanical Child Lock (Main Switch)		-	-	-	-	-	-	-	Optional
Hot Surface Indicator Light		-	-	-	-	-	-	-	-
Hotplate Operation Indicator Light		-	-	Standard	Standard	-	-	-	-
Side Knob Control		Standard	Standard	-	-	-	-	-	-
Front Knob Control		-	-	Standard	Standard	-	Standard	Standard	Standard
Double Side Front Control		-	-	-	-	Standard	-	-	-
Front Triangular Touch Control		-	-	-	-	-	-	-	-
Front Slider Touch Control		-	-	-	-	-	-	-	-
Front Touch Control		-	-	-	-	-	-	-	-
Bevelled Edges		-	-	-	-	-	-	-	Optional
Logo		Optional	Optional	Standard	Standard	Standard	Standard	Standard	Standard
Special Decoration on Glass		Optional	Optional	-	-	-	-	-	-
Vitroceraic Glass Artwork		-	-	-	-	-	-	-	-
Inox Frame		-	-	Standard	-	-	Standard	-	Optional
Stainless Steel Burner Pan		Optional	Optional	Optional	Optional	-	Optional	Optional	Optional
Table Top Installation (not built-in)		-	-	-	-	-	-	-	-
Glass Lid		-	-	-	-	-	-	-	-
Burner Safety Valves		Standard	Standard	Standard	Standard	Standard	Standard	Standard	Standard
Button Ignition		Optional	Optional	Optional	-	-	Optional	-	-
One-touch-Ignition through knobs		Optional	Optional	Optional	Optional	Standard	Optional	Optional	Standard
Enamel Pan Supports		Standard	Standard	Standard	Standard	-	Standard	Standard	-
Cast Iron Pan Supports		Optional	Optional	Optional	Optional	Standard	Optional	Optional	Standard
Cast Iron Burner Caps		Optional	Optional	Optional	Optional	Optional	Optional	Optional	Standard
Coffee Adaptor		Optional	Optional	Optional	Optional	Optional	Optional	Optional	Optional
Wok Adaptor		Optional	Optional	Optional	Optional	-	Optional	Optional	Optional
Vitroceraic Glass Cleaning Spatula		-	-	-	-	-	-	-	-
Gas Conversion Kit		Standard	Standard	Standard	Standard	Standard	Standard	Standard	Optional
<b>Others</b>									
Total Gas Power (Depends on Model) Maximum	kW	8,1	8,1	8,1	8,1	7,5	11,1	11,1	12
Total Electric Power (Depends on Model) Maximum	kW	-	-	-	1	-	-	-	-
Voltage	V	230V~	230V~	230V~	230V~	230V~	230V~	230V~	230V~
RoHS Compliance		Standard	Standard	Standard	Standard	Standard	Standard	Standard	Standard
CE Compliance		Standard	Standard	Standard	Standard	Standard	Standard	Standard	Standard
Carton Box Packaging		Standard	Standard	Standard	Standard	Standard	Standard	Standard	Standard
Packed Product Dimensions (WxDxH)	mm	622 x 580 x 140	622 x 580 x 140	641 x 576 x 161	x	x	731 x 576 x 161	x	x
Loading Quantity 20 ft (Wrapped Carton)		576 (without wok burner) 432 (with wok burner)	576	448	x	x	420	x	x
Loading Quantity 40 ft (Wrapped Carton)		1216 (without wok burner) 912 (with wok burner)	1216	1008	x	x	896	x	x
Loading Quantity 40 HC (Wrapped Carton)		1368 (without wok burner) 912 (with wok burner)	1368	1152	x	x	1024	x	x
Packed Product Dimensions (WxDxH) Box	mm	x	x	x	647 x 582 x 164	647 x 582 x 164	x	769 x 582 x 164	935 x 582 x 164
Loading Quantity 20 ft (Carton Box)	pcs	x	x	x	378	378	x	378	252
Loading Quantity 40 ft (Carton Box)	pcs	x	x	x	840	840	x	840	560
Loading Quantity 40 HC (Carton Box)	pcs	x	x	x	960	960	x	960	640
Net Weight (Depends on Model) Maximum	kg	9,5	9,5	10,7	11,5	11,5	13,7	13,8	20,5
Gross Weight (Depends on Model) Maximum	kg	10,25	10,25	11,13	12,5	12,5	14,2	14,8	21,5

BUILT-IN / TABLE-TOP HOB SPECIFICATION SHEET	BI Electric Hobs		BI Vitro Ceramic Hobs		BI Induction Ceramic Hobs		
	60 CM		60 CM	78 CM	60 CM	78 CM	90CM
	Flat / Surface		C Serie	C Serie	Vestel Induction	Vestel Induction	Vestel Induction
<b>Available Colours</b>							
White		Standard	Optional	Optional	Optional	Optional	Optional
Brown		Optional	-	-	-	-	-
Terre de France		Optional	-	-	-	-	-
Black		Optional	Standard	Standard	Standard	Standard	Standard
Dark Green		Optional	-	-	-	-	-
Stainless Steel		Optional	-	-	-	-	-
<b>Product Dimensions</b>							
Height (max., varies from model to model)	mm	40	41- 47, 5	41	56	56	56
Width	mm	580	590	780	590	590	890
Depth (max., do not include gas connection detail)	mm	510	520	520	520	520	520
<b>Cut-out Dimensions</b>							
Width	mm	560	560	750	560	750	860
Depth	mm	490	490	490	490	490	490
<b>Hob Features</b>							
Hob		Enamel / Stainless Steel	Vitro Ceramic	Vitro Ceramic	Induction Ceramic	Induction Ceramic	Induction Ceramic
Rapid Gas Burner Ø10cm	W	Enamel / Stainless Steel	Vitro Ceramic	Vitro Ceramic	Induction Ceramic	Induction Ceramic	Induction Ceramic
Semi-rapid Gas Burner Ø7.5cm	W	-	-	-	-	-	-
Auxiliary Gas Burner Ø5.5cm	W	-	-	-	-	-	-
Wok (Triple Flame) Gas Burner Mono Ø14cm	W	-	-	-	-	-	-
Wok (Triple Flame) Gas Burner Dual Ø14cm	W	-	-	-	-	-	-
Wok (Triple Flame) Gas Burner Ø11cm	W	-	-	-	-	-	-
Ø 145 mm Hotplate	W	-	-	-	-	-	-
Ø 180 mm Hotplate	W	1000	-	-	-	-	-
Ø 145 mm Rapid Hotplate	W	1500	-	-	-	-	-
Ø 180 mm Rapid Hotplate	W	1500	-	-	-	-	-
Ø145 mm Highlight Element	W	2000	-	-	-	-	-
Ø180 mm Highlight Element	W	-	1200	1200	-	-	-
Ø210 mm Highlight Element	W	-	1800	1800	-	-	-
Ø180 mm Dual Highlight Element	W	-	2300	2300	-	-	-
Ø145 mm Oval Highlight Element	W	-	1700	1700	-	-	-
Ø210 mm Dual Highlight Element	W	-	1800	1800	-	-	-
Ø210 mm Triple Highlight Element	W	-	2200	2200	-	-	-
Ø290 mm Dual Highlight Element	W	-	2300	2300	-	-	-
Ø 160 mm Induction Zone (Serie 1 and Serie 2)	W	-	-	-	-	-	-
Ø 160 mm Induction Zone (Serie 2e)	W	-	-	-	Nominal 1400 W max. Boost 2500 W	-	-
Ø 200 mm Induction Zone (Serie 1)	W	-	-	-	Nominal 2100 W max. Boost 2500 W	Nominal 2100 W max. Boost 2500 W	Nominal 2100 W max. Boost 2500 W
Ø 210 mm Induction Zone (Serie 2)	W	-	-	-	Nominal 2100 W max. Boost 2500 W	-	-
Ø 210 mm Induction Zone (Serie 2e)	W	-	-	-	Nominal 1500 W max. Boost 1700 W	-	-
Ø 250 mm Induction Zone (Serie 1)	W	-	-	-	-	-	Nominal 2800 W max. Boost 3500 W
Ø 290 mm Induction Zone (Serie 2)	W	-	-	-	Nominal 2800 W max. Boost 3500 W	-	-
Flex Induction Zone (1 zone)	W	-	-	-	Nominal 900 W max. Boost 1200 W	Nominal 900 W max. Boost 1200 W	-
Boost Function	-	-	-	-	Standard	Standard	Standard
Pot Dedection	-	-	-	-	Standard	Standard	Standard
Automatic Heatup	-	-	-	-	-	-	-
Timer function for vitro ceramic hobs (If touch control with some hob Configuration selected)	-	-	Optional	Optional	Optional	Optional	Standard
Mode function for induction ceramic hobs (If touch control with some hob Configuration selected)	-	-	-	-	Optional	Optional	-
Bridge zone for induction ceramic hobs (If touch control with some hob Configuration selected)	-	-	-	-	Optional	-	-
Child Lock for vitro ceramic hobs (If touch control selected)	-	-	Standard	Standard	Standard	Standard	Standard
Mechanical Child Lock (Main Switch)	-	-	-	-	-	-	-
Hot Surface Indicator Light	-	-	Standard	Standard	Standard	Standard	Standard
Hotplate Operation Indicator Light	-	Standard	-	-	-	-	-
Side Knob Control	-	Standard	Standard	-	-	-	-
Front Knob Control	-	-	-	-	-	-	-
Double Side Front Control	-	-	-	-	-	-	-
Front Triangular Touch Control	-	-	Optional	Standard	-	-	-
Front Slider Touch Control	-	-	Optional	Optional	Optional	Optional	-
Front Touch Control	-	-	-	-	Optional	Optional	Optional
Bevelled Edges	-	-	Optional	Optional	Optional	Optional	Optional
Logo	-	Standard	Optional	Optional	Optional	Optional	Optional
Special Decoration on Glass	-	-	Optional	Optional	Optional	Optional	Optional
Vitroceramic Glass Artwork	-	-	Slim / Arc	Slim / Arc	Slim / Plus / Line	Slim	Slim
Inox Frame	-	-	Optional	-	Optional	Optional	Optional
Stainless Steel Burner Pan	-	-	-	-	-	-	-
Table Top Installation (not built-in)	-	-	-	-	-	-	-
Glass Lid	-	-	-	-	-	-	-
Burner Safety Valves	-	-	-	-	-	-	-
Button Ignition	-	-	-	-	-	-	-
One-touch-Ignition through knobs	-	-	-	-	-	-	-
Enamel Pan Supports	-	-	-	-	-	-	-
Cast Iron Pan Supports	-	-	-	-	-	-	-
Cast Iron Burner Caps	-	-	-	-	-	-	-
Coffee Adaptor	-	-	-	-	-	-	-
Wok Adaptor	-	-	-	-	-	-	-
Vitroceramic Glass Cleaning Spatula	-	-	Optional	Optional	Optional	Optional	Optional
Gas Conversion Kit	-	-	-	-	-	-	-
<b>Others</b>							
Total Gas Power (Depends on Model) Maximum	kW	-	-	-	-	-	-
Total Electric Power (Depends on Model) Maximum	kW	6	6, 5	8, 3	7, 4	7, 4	10, 8
Voltage	V	230V~ / 400V 2N~	230V~/400V3N~	230V~ / 400V 3N~	230V~ / 400V 3N~	230V~ / 400V 3N~	230V~ / 400V 3N~
RoHS Compliance	-	Standard	Standard	Standard	Standard	Standard	Standard
CE Compliance	-	Standard	Standard	Standard	Standard	Standard	Standard
Carton Box Packaging	-	Standard	Standard	Standard	Standard	Standard	Standard
Packed Product Dimensions (WxDxH)	mm	626 x 580 x 140	620 x 578 x 133	810 x 578 x 133	626 x 581 x 142	816 x 581 x 142	926 x 581 x 142
Loading Quantity 20 ft (Wrapped Carton)	pcs	576	612	476	432	336	252
Loading Quantity 40 ft (Wrapped Carton)	pcs	1216	1292	952	960	672	560
Loading Quantity 40 HC (Wrapped Carton)	pcs	1368	1444	1064	1080	756	560
Packed Product Dimensions (WxDxH) Box	mm	640 x 584 x 152	631 x 580 x 143	x	643 x 583 x 152	x	941 x 583 x 152
Loading Quantity 20 ft (Carton Box)	pcs	405	576	x	405	x	252
Loading Quantity 40 ft (Carton Box)	pcs	900	1152	x	900	x	560
Loading Quantity 40 HC (Carton Box)	pcs	1020	1296	x	1020	x	560
Net Weight (Depends on Model) Maximum	kg	9, 5	9, 5	10, 15	11	12	16
Gross Weight (Depends on Model) Maximum	kg	10, 25	10, 25	11	12	13	17



BUILT-IN / TABLE-TOP HOB SPECIFICATION SHEET		TT Gas/ Comnined/ Gas Securit Hobs				TT Electric Hobs		
		60 CM	60 CM	60 CM	60 CM	60 CM	60 CM	60 CM
		Flat / Surface	Smoothline	New Gen.	PlusX	Flat / Surface	Smoothline	New Gen.
<b>Available Colours</b>								
White		Standard	Standard	Standard	Optional	Standard	Standard	Standard
Brown		Optional	Optional	-	Optional	Optional	Optional	-
Terre de France		Optional	Optional	-	Optional	Optional	Optional	-
Black		Optional	Optional	Optional	Standard	Optional	Optional	Optional
Dark Green		Optional	Optional	-	Optional	Optional	Optional	-
Stainless Steel		Optional	Optional	Optional	Optional	Optional	Optional	Optional
<b>Product Dimensions</b>								
Height (max., varies from model to model)	mm	95, 5 - 104, 5	95, 5 - 104, 5	95, 5 - 104, 5	104	56, 5 - 104, 5	56, 5 - 104, 5	56, 5 - 104, 5
Width	mm	585	585	580	597	585	585	585
Depth (max., do not include gas connection detail)	mm	540	540	540	526	540	540	540
<b>Cut-out Dimensions</b>								
Width	mm	-	-	-	-	-	-	-
Depth	mm	-	-	-	-	-	-	-
<b>Hob Features</b>								
Hob		Enamel / Stainless Steel	Enamel / Stainless Steel	Enamel / Stainless Steel	Securit	Enamel / Stainless Steel	Enamel / Stainless Steel	Enamel / Stainless Steel
Rapid Gas Burner Ø10cm	W	3000	3000	3000	3000	-	-	-
Semi-rapid Gas Burner Ø7.5cm	W	1750	1750	1750	1750	-	-	-
Auxiliary Gas Burner Ø5.5cm	W	1000	1000	1000	1000	-	-	-
Wok (Triple Flame) Gas Burner Mono Ø14cm	W	3600	3600	3600	3600	-	-	-
Wok (Triple Flame) Gas Burner Dual Ø14cm	W	-	-	-	-	-	-	-
Wok (Triple Flame) Gas Burner Ø11cm	W	-	-	-	-	-	-	-
Ø 145 mm Hotplate	W	-	1000	-	1000	1000	1000	1000
Ø 180 mm Hotplate	W	1500	-	1500	-	1500	1500	1500
Ø 145 mm Rapid Hotplate	W	-	1500	-	-	1500	1500	1500
Ø 180 mm Rapid Hotplate	W	2000	-	2000	-	2000	2000	2000
Ø145 mm Highlight Element	W	-	-	-	-	-	-	-
Ø180 mm Highlight Element	W	-	-	-	-	-	-	-
Ø210 mm Highlight Element	W	-	-	-	-	-	-	-
Ø180 mm Dual Highlight Element	W	-	-	-	-	-	-	-
Ø145 mm Oval Highlight Element	W	-	-	-	-	-	-	-
Ø210 mm Dual Highlight Element	W	-	-	-	-	-	-	-
Ø210 mm Triple Highlight Element	W	-	-	-	-	-	-	-
Ø290 mm Dual Highlight Element	W	-	-	-	-	-	-	-
Ø 160 mm Induction Zone(Serie 1 and Serie 2)	W	-	-	-	-	-	-	-
Ø 200 mm Induction Zone(Serie 1)	W	-	-	-	-	-	-	-
Ø 210 mm Induction Zone(Serie 2)	W	-	-	-	-	-	-	-
Ø 250 mm Induction Zone(Serie 1)	W	-	-	-	-	-	-	-
Ø 290 mm Induction Zone(Serie 2)	W	-	-	-	-	-	-	-
Boost Funcion		-	-	-	-	-	-	-
Pot Dedection		-	-	-	-	-	-	-
Automatic Heatup		-	-	-	-	-	-	-
Timer function for vitro ceramic hobs (If touch control with some hob Configuration selected)		-	-	-	-	-	-	-
Mode function for induction ceramic hobs (If touch control with some hob Configuration selected)		-	-	-	-	-	-	-
Bridge zone for induction ceramic hobs (If touch control with some hob Configuration selected)		-	-	-	-	-	-	-
Child Lock for vitro ceramic hobs (If touch control selected)		-	-	-	-	-	-	-
Mechanical Child Lock (Main Switch)		-	-	-	-	-	-	-
Hot Surface Indicator Light		-	-	-	-	-	-	-
Hotplate Operation Indicator Light		Standard	Standard	Standard	Standard	Standard	Standard	Standard
Side Knob Control		Standard	Standard	Standard	Standard	Standard	Standard	Standard
Front Knob Control		-	-	-	Standard	-	-	-
Double Side Front Control		-	-	-	-	-	-	-
Front Triangular Touch Control		-	-	-	-	-	-	-
Front Slider Touch Control		-	-	-	-	-	-	-
Front Touch Control		-	-	-	-	-	-	-
Bevelled Edges		-	-	-	-	-	-	-
Logo		Standard	Standard	Standard	Standard	Standard	Standard	Standard
Special Decoration on Glass		-	-	-	-	-	-	-
Vitroceraic Glass Artwork		-	-	-	-	-	-	-
Inox Frame		-	-	-	-	-	-	-
Stainless Steel Burner Pan		-	-	-	-	-	-	-
Table Top Installation (not built-in)		Standard	Standard	Standard	Standard	Standard	Standard	Standard
Glass Lid		Optional	Optional	Optional	-	Optional	Optional	Optional
Burner Safety Valves		Standard	Standard	Standard	Standard	-	-	-
Button Ignition		Optional	Optional	Optional	Optional	-	-	-
One-touch-Ignition through knobs		Optional	Optional	Optional	Optional	-	-	-
Enamel Pan Supports		Standard	Standard	Standard	Standard	-	-	-
Cast Iron Pan Supports		Optional	Optional	Optional	Optional	-	-	-
Cast Iron Burner Caps		Optional	Optional	Optional	Optional	-	-	-
Coffee Adaptor		Optional	Optional	Optional	Optional	-	-	-
Wok Adaptor		Optional	Optional	Optional	Optional	-	-	-
Vitroceraic Glass Cleaning Spatula		-	-	-	-	-	-	-
Gas Conversion Kit		Standard	Standard	Standard	Standard	-	-	-
<b>Others</b>								
Total Gas Power (Depends on Model) Maximum	kW	8,1	8,1	8,1	8,1	-	-	-
Total Electric Power (Depends on Model) Maximum	kW	-	-	-	1	6	6	6
Voltage	V	230V~	230V~	230V~	230V~	230 / 400V 3N~	230 / 400V 3N~	230 / 400V 3N~
RoHS Compliance		Standard	Standard	Standard	Standard	Standard	Standard	Standard
CE Compliance		Standard	Standard	Standard	Standard	Standard	Standard	Standard
Carton Box Packaging		Standard	Standard	Standard	Standard	Standard	Standard	Standard
Packed Product Dimensions (WxDxH)	mm	643 x 645 x 132	643 x 645 x 132	x	x	643 x 645 x 132	643 x 645 x 132	x
Loading Quantity 20 ft (Wrapped Carton)	pcs	408	408	x	x	408	408	x
Loading Quantity 40 ft (Wrapped Carton)	pcs	918	918	x	x	918	918	x
Loading Quantity 40 HC (Wrapped Carton)	pcs	1026	1026	x	x	1026	1026	x
Packed Product Dimensions (WxDxH) Box	mm	662 x 648 x 140 (default for glass lid option)	662 x 648 x 140 (default for glass lid option)	662 x 648 x 140	645 x 648 x 140	662 x 648 x 140 (default for glass lid option)	662 x 648 x 140 (default for glass lid option)	662 x 648 x 140
Loading Quantity 20 ft (Carton Box)	pcs	348	348	348	384	384	384	384
Loading Quantity 40 ft (Carton Box)	pcs	864	864	864	864	864	864	864
Loading Quantity 40 HC (Carton Box)	pcs	972	972	972	972	972	972	972
Net Weight (Depends on Model) Maximum	kg	13	13	14	15	13, 5	13, 5	14, 5
Gross Weight (Depends on Model) Maximum	kg	14.25	14.25	15	16	14.75	14.75	15, 5

DOMINO HOB SPECIFICATION SHEET		Domino Gas Hobs 30 CM	Domino Electric Hobs 30 CM	Domino Gas Securit Hobs 30 CM	Domino Vitro Ceramic Hobs 30 CM	Domino Induction Ceramic Hobs 30 CM
<b>Available Colours</b>						
White		-	-	Optional	Optional	Optional
Brown		-	-	-	-	-
Terre de France		-	-	-	-	-
Black		-	-	Standard	Standard	Standard
Dark Green		-	-	-	-	-
Stainless Steel		Standard	Standard	-	-	-
<b>Product Dimensions</b>						
Height (varies from model to model)	mm	42, 5	42, 5	47, 5	47, 5	56
Width	mm	290	290	290	290	290
Depth	mm	510	510	520	520	520
<b>Cut-out Dimensions</b>						
Width	mm	270	270	270	270	270
Depth	mm	490	490	490	490	490
<b>Hob Features</b>						
Hob		Stainless Steel	Stainless Steel	Securit	Vitro Ceramic	Induction Ceramic
Rapid Gas Burner Ø10cm	W	3000	-	3000	-	-
Semi-rapid Gas Burner Ø7.5cm	W	-	-	-	-	-
Auxiliary Gas Burner Ø5.5cm	W	1000	-	1000	-	-
Wok (Triple Flame) Gas Burner Ø14cm	W	3600	-	3600	-	-
Ø 145 mm Hotplate	W	-	1000	-	-	-
Ø 180 mm Hotplate	W	-	1500	-	-	-
Ø 145 mm Rapid Hotplate	W	-	-	-	-	-
Ø 180 mm Rapid Hotplate	W	-	2000	-	-	-
Ø145 mm Highlight Element	W	-	-	-	1200	-
Ø180 mm Highlight Element	W	-	-	-	1800	-
Ø210 mm Highlight Element	W	-	-	-	-	-
Ø180 mm Dual Element	W	-	-	-	1700	-
Ø145 mm Oval Element	W	-	-	-	-	-
Ø210 mm Dual Element	W	-	-	-	-	-
Ø210 mm Triple Element	W	-	-	-	-	-
Ø270 mm Triple Element	W	-	-	-	-	-
Rectangular Element	W	-	-	-	-	-
Ø 160 mm Induction Zone	W	-	-	-	-	Nominal 1400W max. Boost 1800W
Ø 200 mm Induction Zone	W	-	-	-	-	Nominal 2100W max. Boost 2500W
Oval Induction Zone				-	-	-
Boost Function				-	-	Standard
Pot Dedection		-	-	-	-	Standard
Automatic Heatup		-	-	-	-	Standard
Timer function for vitro ceramic hobs (If touch control with some hob Configuration selected)		-	-	-	-	Standard
Child Lock for vitro ceramic hobs (If touch control selected)		-	-	-	Standard	Standard
Hot Surface Indicator Light		-	-	-	Standard	Standard
Hotplate Operation Indicator Light		-	Standard	-	-	-
Side Knob Control		-	Standard	-	-	-
Front Knob Control		Standard	-	Standard	Standard	-
Front Touch Control		-	-	-	Optional	Standard
Front Slim Touch Control		-	-	-	-	-
Bevelled Edges		-	-	-	Optional	Optional
Logo		Standard	Standard	Optional	Optional	Optional
Special Decoration on Glass		-	-	Optional	Optional	Optional
Inox Frame		-	-	Optional	Optional	Optional
Stainless Steel Burner Pan		-	-	Optional	-	-
Table Top Installation (not built-in)		-	-	-	-	-
Glass Lid		-	-	-	-	-
Burner Safety Valves		Optional	-	Optional	-	-
Button Ignition		Optional	-	-	-	-
One-touch-Ignition through knobs		Optional	-	Optional	-	-
Enamel Pan Supports		Standard	-	Standard	-	-
Cast Iron Pan Supports		Optional	-	Optional	-	-
Cast Iron Burner Caps		Optional	-	Optional	-	-
Coffee Adaptor		Optional	-	Optional	-	-
Wok Adaptor		Optional	-	Optional	-	-
Vitroceramic Glass Cleaning Spatula		-	-	-	Optional	Optional
Gas Conversion Kit		Standard	-	Standard	-	-
Gas Conversion Kit		Standard	-	Standard	-	-
<b>Others</b>						
Total Power (Depends on Model) Maximum	kW	4	3, 5	4	3	3, 6
Voltage	V	230 V ~	230 V ~	230V ~	230 V~	230 V~
RoHS Compliance		Standard	Standard	Standard	Standard	Standard
CE Compliance		Standard	Standard	Standard	Standard	Standard
Carton Box Packaging		Standard	Standard	Standard	Standard	Standard
Packed Product Dimensions (WxDxH) Box	mm	x	x	330 x 578 x 140	326 x 578 x 133	332 x 581 x 142
Net Weight (Depends on Model) Maximum	kg	5, 5	4, 75	4, 7	4, 7	5, 5
Gross Weight (Depends on Model) Maximum	kg	6	5, 4	5	5	6, 2
Container Loading Quantity (20 ft Container)	pcs	1190	1190	1088	1088	864
Container Loading Quantity (40 ft Container)	pcs	2499	2499	2304	2304	1920
Container Loading Quantity (40 ft HC Container)	pcs	2793	2793	2592	2592	2160

POLY HOB SPECIFICATION SHEET		Electric Built-in Hob	Vitroceramic Built-in Hob	Induction Built-in Hob
		60cm	60cm	60cm
<b>Available Colours</b>				
White		Standard	Optional	-
Brown		Optional	-	-
Terre de France		Optional	-	-
Black		Optional	Standard	Standard
Dark Green		Optional	-	-
Stainless Steel		Optional	-	-
<b>Product Dimensions</b>				
Height	mm	39	41	53
Width	mm	580	590	590
Depth	mm	510	520	520
<b>Cut-out Dimensions</b>				
Width	mm	560	560	560
Depth	mm	490	490	490
<b>Hob Features</b>				
Hob		Enamel	Vitroceramic	Induction
Ø 145 mm Hotplate	W	1000	-	-
Ø 180 mm Hotplate	W	1500	-	-
Ø145 mm Highlight Element	W	-	1200	-
Ø180 mm Highlight Element	W	-	1800	-
Ø180 mm Dual Element	W	-	1700	-
Ø145 mm Oval Element	W	-	1800	-
Ø210 mm Highlight Element	W	-	2300	-
Ø145 mm Radiant Heating Element	W	-	1200	-
Ø180 mm Radiant Heating Element	W	-	1700	-
Ø 160 mm Induction Zone	W	-	-	Nominal 1400 W max. Boost 1800 W
Ø 200 mm Induction Zone	W	-	-	Nominal 2100 W max. Boost 2500 W
Boost Function		-	-	Standard
Pot Dedection		-	-	Standard
Timer (If touch control and some hob Configuration selected for vitroceramic hob)		-	-	Standard
Child Lock (If touch control selected for vitroceramic hob)		-	-	Standard
Hot Surface Indicator Light		-	Standard	Standard
Controls on the built-in oven panel		Standard	Standard	Standard
Controllor		7 step switch	Energy Regulator/ 7 step switch (with radiant element)	Encoder
Hotplate Operation Indicator Light		Standard	-	-
Bevelled Edges		-	Optional	Optional
Logo		Standard	Optional	Optional
Special Artwork on Glass		-	Slim	Slim
STANDARD Vitroceramic Glass Artwork		-	Slim Design Arc Design Point Design	Slim Design Arc Design Point Design
Inox Frame		-	Optional	Optional
Vitroceramic Glass Cleaning Spatula		-	Optional	Optional
<b>Others</b>				
Total Power (Depends on Model) Maximum	kW	8,1	9,6	10,5
Voltage	V	230V~	230V~	230V~
RoHS Compliance		Standard	Standard	Standard
CE Compliance		Standard	Standard	Standard
Carton Box Packaging		Standard	Standard	Standard
Packed Product Dimensions (WxDxH)	mm	628x580x137	618x578x132	624x580x142
Net Weight (Depends on Model) Maximum	kg	8,75	7	11
Gross Weight (Depends on Model) Maximum	kg	9,5	8	12

75 It Built-in Oven Energy Class Declarations			
Model Description	Oven Function Designation	Available Energy Class Declerations	Function used for Energy Declaration
Turbo Fan	(05/06/07/09/16/17/19/23/24/50/51/52/53)	A, A+	Fan + Ring
Fan assisted	(10/11/12/20/22/25/26)	A	Upper + Lower + Fan

\*: Owner of this document is Vestel Beyaz Esya A.S.(VBE) . VBE has right to make changes on these values without notification by referring this document. - 14.05.2015

65 It Built-in Oven Energy Class Declarations			
Model Description	Oven Function Designation	Available Energy Class Declerations	Function used for Energy Declaration
Turbo Fan	(05/06/07/09/16/17/19/23/24/50/51/52/53)	A, A+	Fan + Ring
Turbo Lite	(50/51)	A++	Fan + Ring
Fan assisted	(10/11/12/20/22/25/26)	A	Upper + Lower + Fan

\*: Owner of this document is Vestel Beyaz Esya A.S.(VBE) . VBE has right to make changes on these values without notification by referring this document. - 14.05.2015

60 It Built-in Oven Energy Class Declarations			
Model Description	Oven Function Designation	Available Energy Class Declerations	Function used for Energy Declaration
Static	(01/02/04/13/15)	A	Upper + Lower
Turbo Fan	(05/06/07/09/16/17/19/23/24/27/28/29/50/51/52/53)	A	Fan + Ring
Fan assisted	(10/11/12/20/22/25/26)	A	Upper + Lower + Fan

\*: Owner of this document is Vestel Beyaz Esya A.S.(VBE) . VBE has right to make changes on these values without notification by referring this document. - 14.05.2015

Electric Oven Function for Built-in Ovens						
Function ID	Identity in the Market	Heating Element, Fan, Turnspit, Grill Availability	Oven Functions	Electrical Power at 230V	Number of Functions	Limitations
01	Static oven	(Top + Bottom)	0 / Top+bottom / bottom / top	2300	3	-
02	Static oven	(Top + Bottom) + Grill + Turnspit	0 / Top+bottom / bottom / top / grill+turnspit	2300	4	-
04	Static oven	(Top + Bottom) + Grill + Turnspit	0 / Ovenlight / top+bottom / bottom / top / grill+turnspit / double grill+turnspit	2600	6	-
06	FAN+RING oven	(Fan + Ring) + Grill + Turnspit	0 / Defrost / fan+ring / grill+turnspit / grill+fan+turnspit	2000	4	-
07	Multifunction oven	(Top + Bottom + Fan + Ring) + Grill + Turnspit	0 / Defrost / fan+ring / top+bottom / top+bottom+fan / grill+turnspit / grill+fan+turnspit	2300	6	-
09	Multifunction oven	(Top + Bottom + Fan + Ring) + Grill + Turnspit	0 / Ovenlight / defrost / fan+ring / top+bottom / top+bottom+fan / pizza / grill+turnspit / double grill+turnspit / double grill+fan+turnspit	3100	9	-
10	Fan assisted oven	(Top + Bottom + Fan) + Grill + Turnspit	0 / Defrost / top+bottom / top+bottom+fan / grill+turnspit / grill+fan+turnspit	2300	5	-
12	Fan assisted oven	(Top + Bottom + Fan) + Grill + Turnspit	0 / Ovenlight / defrost / top+bottom / top+bottom+fan / bottom+fan / grill+turnspit / double grill+turnspit / double grill+fan+turnspit	2600	8	-
13	Static oven	(Top + Bottom) + Grill	0 / Top+bottom / bottom / top / grill	2300	4	-
15	Static oven	(Top + Bottom) + Grill	0 / Ovenlight / top+bottom / bottom / top / grill / double grill	2600	6	-
16	FAN+RING oven	(Fan + Ring) + Grill	0 / Defrost / fan+ring / grill / grill+fan	2000	4	-
17	Multifunction oven	(Top + Bottom + Fan + Ring) + Grill	0 / Defrost / fan+ring / top+bottom / top+bottom+fan / grill / grill+fan	2300	6	-
19	Multifunction oven	(Top + Bottom + Fan + Ring) + Grill	0 / Ovenlight / defrost / fan+ring / top+bottom / top+bottom+fan / pizza / grill / double grill / double grill+fan	3100	9	-
20	Fan assisted oven	(Top + Bottom + Fan) + Grill	0 / Defrost / top+bottom / top+bottom+fan / grill / grill+fan	2300	5	-
22	Fan assisted oven	(Top + Bottom + Fan) + Grill	0 / Ovenlight / defrost / top+bottom / top+bottom+fan / bottom+fan / grill / double grill / double grill+fan	2600	8	-
23	Multifunction oven	(Top + Bottom + Fan + Ring)	0 / Defrost / fan+ring / top+bottom / top+bottom+fan	2300	4	-
24	Multifunction oven	(Top + Bottom + Fan + Ring) + Turnspit	0 / Defrost / fan+ring+turnspit / top+bottom+turnspit / top+bottom+fan+turnspit	2300	4	-
25	Fan assisted oven	(Top + Bottom + Fan)	0 / Defrost / top+bottom / top+bottom+fan	2300	3	-
26	Fan assisted oven	(Top + Bottom + Fan) + Turnspit	0 / Defrost / top+bottom+turnspit / top+bottom+fan+turnspit	2300	3	-
27	Fan assisted oven	(Top + Bottom + Fan) + Grill	0 / Defrost / top+bottom / top+bottom+fan / grill / double grill / pyrolysis	2600	6	Available for only pyrolytic oven
28	Multifunction oven	(Top + Bottom + Fan + Ring) + Grill	0 / Defrost / fan+ring / top+bottom / top+bottom+fan / grill / double grill / double grill + fan / pyrolysis	2600	8	Available for only pyrolytic oven
29	Multifunction oven	(Top + Bottom + Fan + Ring) + Grill + Turnspit	0 / Defrost / fan+ring / top+bottom / top+bottom+fan / grill+turnspit / double grill+turnspit / double grill+fan+turnspit / pyrolysis	2600	8	Available for only pyrolytic oven
50	Multifunction oven	(Top + Bottom + Fan + Ring) + Grill + Turnspit	0 / Ovenlight / defrost / fan+ring / top+bottom / top+bottom+fan / pizza / grill + turnspit / double grill + turnspit / double grill+fan + turnspit / vap clean	3100	10	-
51	Multifunction oven	(Top + Bottom + Fan + Ring) + Grill	0 / Ovenlight / defrost / fan+ring / top+bottom / top+bottom+fan / pizza / grill / double grill / double grill+fan / vap clean	2300	10	-
52	Fan assisted oven	(Top + Bottom + Fan) + Grill	0 / Defrost / bottom / top+bottom / top+bottom+fan / grill / grill+fan	2300	6	-
53	Fan assisted oven	(Top + Bottom + Fan)	0 / Bottom / top / top+bottom / top+bottom+fan	2300	4	-
54	Fan assisted oven	(Top + Bottom + Fan + Ring) + Grill + Turnspit	0 / Defrost / bottom / top+bottom / top+bottom+fan / grill+turnspit / grill+fan+turnspit	2600	7	-
55	Fan assisted oven	(Top + Bottom + Fan) + Turnspit	0 / Bottom / top / top+bottom+turnspit / top+bottom+fan+turnspit	2300	5	-
56	Multifunction oven	(Top + Bottom + Fan + Ring) + Grill + Turnspit	0 / Ovenlight / defrost / fan+ring / top+bottom / top+bottom+fan / pizza / grill / double grill / double grill+fan / vap clean + / steam aid cooking	3100	12	-
57	Multifunction oven	(Top + Bottom + Fan + Ring) + Grill	0/Ovenlight/defrost/top+bottom/top+bottom+fan/fan+ring/pizza/3d/grill/grill+fan/double grill/double grill+fan	3100	10	Available for only monochrome control unit
59	Multifunction oven	(Top + Bottom + Fan + Ring) + Grill	0/Ovenlight/bottom/top/top+bottom/top+bottom+fan/grill/grill+fan/fan+ring/3d	2600	9	-
61	Fan assisted oven	(Top + Bottom + Fan)	0/Top/bottom/top+bottom/top+bottom+fan/bottom+fan	2300	5	-
62	Multifunction oven	(Top + Bottom + Fan + Ring) + Grill	0/Ovenlight/defrost/top/bottom/top+bottom/top+bottom+fan/fan+ring/grill+fan/double grill	2600	8	-
64	Multifunction oven	(Top + Bottom + Fan + Ring) + Grill	0/Defrost/fan+ring/bottom/top+bottom/top+bottom+fan/pizza/double grill/double grill+fan/vap clean/pyrolysis	3100	9	Available for only led slim touch control unit



**Built-in / Table Top Hobs Container Loading Quantities and Packaging Sizes**

Product Family	Size	Product Definitions	Product Code Structure	Packaging Size (WxDxH) mm	40 HC	40 ft	20 ft	
Gas / Combined	60 cm	gas/ combined hobs (Classic)	GG66Y-GK66Y Classic	626 x 560 x 130	1444	1292	612	
		gas/ combined hobs (Flat R/ Flat S/ Surface)	GG66Y-GK66Y Flat R-Flat S-Surface	626 x 580 x 140	1368	1216	576	
		gas/ combined hobs (Flat R/ Flat S/ Surface)	GG66Y-GK66Y Flat R-Flat S-Surface Box	640 x 584 x 152	960	840	378	
		gas/ combined hobs (Flat T)	GG66Y-GK66Y Flat T Box	647 x 582 x 164	1152	1008	448	
		gas on glass hobs	GS66Y21-GS66Y40	622 x 580 x 140	1368	1216	576	
		gas on glass hobs (One is triple flame)	GS66Y41	622 x 580 x 140	912	912	432	
	70 cm	gas/ gas on glass hobs (Plusx-Pure-Division-Smart Plus)	GG61O-GS61O-GS61Y-GG61D-GS62Y	647 x 582 x 164	1152	1008	448	
		75 cm	gas/ gas on glass hobs (Plusx-Smart Plus)	GG71O-GS71O-GS72O	769 x 582 x 164	960	840	392
			gas on glass hobs	GS75O	822 x 522 x 164	896	784	336
			gas on glass hobs	GS90O	935 x 582 x 164	768	672	336
Vitre Ceramic	60 cm	vitro ceramic hobs	GC66	620 x 578 x 133	1444	1292	612	
	78 cm	vitro ceramic hobs, box	GC66 Box	631 x 580 x 143	1296	1152	512	
Induction	60 cm	induction hobs	GI66	626 x 581 x 142	1368	1216	576	
		induction hobs, box	GI66 Box	643 x 583 x 152	1224	1080	480	
	90 cm	induction hobs	GI78	816 x 581 x 142	1008	896	384	
Domino	30 cm	built-in induction hobs	GI90 Box	936 x 583 x 152	748	660	315	
		gas/ electric hobs	GG30-GE30	331 x 566 x 143	2646	2304	1120	
		gas on glass hobs	GS30	330 x 578 x 140	2520	2240	1008	
		induction hobs	GI30	332 x 581 x 142	2520	2240	1008	
		induction hobs, box	GI30, Box	340 x 580 x 138	2660	2240	1024	
Table Top	60 cm	vitro ceramic hobs	GC30	326 x 578 x 133	2660	2380	1071	
		gas/ electric/ combined hobs	SG/SK/SE (60Y-66Y)	662 x 648 x 140	972	864	384	
		gas on glass hobs hobs (Plusx)	SS61O	645 x 648 x 140	972	864	384	

**Built-in Ovens Container Loading Quantities and Packaging Sizes**

Product Family	Packaging and Container Couples	Packaging Size (WxDxH) mm	Loading Quantity	
Built-In Ovens	60 cm built-in oven shrink 20ft	650x640x650	81	
	60 cm built-in oven shrink 40ft	650x640x650	162	
	60 cm built-in oven shrink 40 HC	650x640x650	216	
	60 cm built-in oven Cardboard Box with Lid (without handle cap) 20 ft	660x650x660	81	
	60 cm built-in oven Cardboard Box with Lid (without handle cap) 40 ft	660x650x660	162	
	60 cm built-in oven Cardboard Box with Lid (without handle cap) 40 hc	660x650x660	216	
	60 cm built-in oven Cardboard Box with Lid (with handle cap) 20 ft	665x655x665	81	
	60 cm built-in oven Cardboard Box with Lid (with handle cap) 40 ft	665x655x665	162	
	60 cm built-in oven Cardboard Box with Lid (with handle cap) 40 hc	665x655x665	216	
	60 cm built-in oven Cardboard Box without Lid 20 ft	660x645x650	81	
	60 cm built-in oven Cardboard Box without Lid 40 ft	660x645x650	162	
	60 cm built-in oven Cardboard Box without Lid 40 hc	660x645x650	216	
	Polyvalente Built-In Oven And Hob Set, Promotion Product	60 cm Polyvalente shrink 20ft	650x640x795	81
		60 cm Polyvalente shrink 40ft	650x640x795	162
60 cm Polyvalente shrink 40 HC		650x640x795	162	
60 cm Polyvalente box 20ft		660x650x795	81	
60 cm Polyvalente box 40ft		660x650x795	162	
60 cm Polyvalente box 40 HC		660x650x795	162	

60cm Vitroceramic Hob with Front Triangular Touch Control (FRTR)			
Hob ID	Configuration	Element Placement	Control System
1	2 x 145, 2 x 180 highlight element		Standard or slider control
2	2 x 145, 1 x 180, 1 x 180 dual highlight element		Standard
3	2 x 145, 1 x 180, 1 x 210 highlight element		Standard
6	2 x 145, 1 x 180 dual, 1 x oval highlight element		Standard or slider control
8	2 x 145, 1 x 180, 1 x 180 dual highlight element with timer		Standard or slider control
9	2 x 145, 1 x 180 dual, 1 x oval highlight element with timer		Standard or slider control
10	2 x 145, 1 x 180, 1 x 210 triple highlight element with timer		Standard
22*	1 x 145, 1x180, 1 x 210 highlight element		Standard
25	1 x 145, 1 x 180, 1 x 290 dual highlight element		Standard
26	1 x 145, 1 x 180, 1 x 290 dual highlight element with timer		Slider control

\*Available upon request

78cm Vitroceramic Hob Configurations			
Hob ID	Highlight Element Configuration	Element Placement	Control System
1	2 x 145 Highlight, 1 x oval, 1 x 180 highlight element		Standard
10	1 x 145 Highlight, 1 x 180, 1 x dual, 1 x oval highlight element with timer		Standard or slider control

\*: Available upon request with warranty of a certain amount.

60cm Vitroceramic Hob with Side Knob Control (SDKB)			
Hob ID	Configuration	Element Placement	Limitations
1	2 x 145, 2 x 180 highlight element		None
3	2 x 145, 1 x 180, 1 x 210 highlight element		None

\*Available upon request

60cm Vitroceramic Hob for Combi Built-in Oven (POLY)			
Hob ID	Configuration	Element Placement	Control System
4	2 x 145, 2 x 180 highlight element (U shape order_145-180-145-180)		None
9	2 x 145, 1 x 180 dual, 1 x oval highlight element (U shape order_145 - 180dual - 145 - oval)		None
14*	2 x 145, 1 x oval, 1 x 210 dual highlight element (U shape order_145 - 210dual - 145 - oval)		None

\*Available upon request

Induction Hob Configurations for Built-in Hobs and Polyvalente Hobs				
Hob ID	Configuration	Limitations	Element Placement	Control System
28	1 x 160mm, 1400/1800W induction element 2 x 210mm, 2100/2500W induction element	Available only for 60cm		Standard
29	1 x 160mm, 1400/1800W induction element 2 x 210mm, 2100/2500W induction element with timer	Available only for 60cm		Standard or slider control
30	1 x 160mm, 1400/1800W induction element 1 x 210mm, 2100/2500W induction element 1 x 290mm, 2800/3500W induction element	Available only for 60cm		Standard
31	1 x 160mm, 1400/1800W induction element 1 x 210mm, 2100/2500W induction element 1 x 290mm, 2800/3500W induction element with timer	Available only for 60cm		Standard or slider control
32	2 x 160mm, 1400/1800W induction element 2 x 210mm, 2100/2500W induction element	Available only for 60cm		Standard
33	2 x 160mm, 1400/1800W induction element 2 x 210mm, 2100/2500W induction element with timer	Available only for 60cm		Standard or slider control
34	2 x 160mm, 1400/1800W induction element 1 x 290mm, 2800/3500W induction element with timer	Available only for 60cm		Standard or slider control
35	3 x 160mm, 1400/1800W induction element 1 x 200mm, 2100/2500W induction element bridge zone, mode function, timer	Available only for 60cm		Standard or slider control

60cm Side Controlled Solid Hotplate and Polyvalente Built-in Electric Hob Configurations			
Hob ID	Configuration	Limitations	Element Placement
01	2 x 145, 2 x 180 hotplate	None	
02	2 x 145, 1 x 180, 1 x 180 rapid hotplate	None	
03	1 x 145, 1 x 145 rapid, 1 x 180, 1 x 180 rapid hotplate	Not available for polyvalente type hob	
*04	1 x 145, 1 x 145 rapid, 2 x 180 hotplate	Not available for polyvalente type electric hob	

60cm side controlled solid hotplate hobs are available for table top  
 \*: Available upon request with warranty of a certain amount.

60cm Pure Design Combined Hobs Configurations			
Hob ID	Configuration	Limitations	Element Placement
62	2 Gas Heaters (1 x Rapid & 1 x Semi Rapid) 2 Hilight Heaters (1X180 & 1X145)	Available for only side knob control	
67	3 Gas Heaters (1 x Semi Rapid & 1 x Auxiliary & 1 x Rapid) 1 Hilight Heater (1X180 DUAL)	Available for only side knob control	
69	2 Gas Heaters (1 x Rapid & 1 x Semi Rapid) 2 Induction Heaters with timer 1X200 (Nominal 2100W max.Boost 2500W) 1X160 (Nominal 1400W max.Boost 1800W)	Available for only side control. Touch control is standard for induction heaters, knob control is standard for gas heaters.	

60cm Side Controlled Gas Hob Configurations			
Hob ID	Configuration	Limitations	Element Placement
31	1 x Auxiliary, 1 x Semi Rapid, 1 x Rapid Burner, 1 x Hotplate	Not available for gas on glass hob	
40	1 x Auxiliary, 2 x Semi Rapid, 1 x Rapid Burner	None	
41	1 x Auxiliary, 2 x Semi Rapid, 1 x Triple Flame Burner	None	

60cm side controlled gas hobs are available for table top application

90cm Front Controlled Gas Hob Configurations			
Hob ID	Configuration	Limitations	Element Placement
51	1 x Auxiliary, 2 x Semi Rapid, 1 x Rapid, 1 x Triple Flame Burner (MONO)	None	
53	2 x Auxiliary, 2 x Semi Rapid, 1 x Rapid, 1 x Triple Flame Burner (DUAL)	None	

60cm Front Controlled Gas Hob Configurations			
Hob ID	Configuration	Limitations	Element Placement
31	1 x Auxiliary, 1 x Semi Rapid, 1 x Rapid Burner, 1 x Hotplate	Model I not available for gas on glass hob	
40	1 x Auxiliary, 2 x Semi Rapid, 1 x Rapid Burner	None	
41	1 x Auxiliary, 2 x Semi Rapid, 1 x Triple Flame Burner	None	

70cm Front Controlled Gas Hob Configurations			
Hob ID	Configuration	Limitations	Element Placement
50	1 x Auxiliary, 2 x Semi Rapid, 2 x Rapid Burner	Not available for Plus x	
51	1 x Auxiliary, 2 x Semi Rapid, 1 x Rapid, 1 x Triple Flame Burner	None	

DUO Stripe	TRIO Stripe
Glass Control Panel	Glass Control Panel
Cladding	Cladding

30cm Gas On Glass Hob Configurations		
Hob ID	Configuration	Element Placement
10	1 x Triple Flame Burner	
20	1 x Auxiliary, 1 x Rapid Burner	

30cm Induction Hob Configurations		
Hob ID	Configuration	Element Placement
25	1 x 160 mm, 1400 / B1800W induction element 1 x 200 mm, 2100 / B2500W induction element with timer	

30cm Solid Hotplate Hob Configurations		
Hob ID	Configuration	Element Placement
05	1 x 145, 1 x 180 hotplate	
*06	1x145 rapid hotplate, 1x180 rapid hotplate	
*07	1x145rapid hotplate, 1x180 hotplate	
08	1x145 hotplate, 1x180 rapid hotplate	

30cm Vitroceramic Hob Configurations		
Hob ID	Configuration	Element Placement
16	1 x 180 Highlight, 1 x 145 Highlight element	
19	1 x 180 Highlight, 1 x 145 Highlight element with timer	
20	1 x 180 Dual, 1 x 145 Highlight element with timer	

All element Configurations are applicable for both knob control and touch control unit

\*: Available upon request with warranty of a certain amount.

	I Type Add_on		U Type Add_on		O Type		Mono Stripe	
	Inox Control Panel	Glass Control Panel	Inox Control Panel	Glass Control Panel	Inox Control Panel	Glass Control Panel	Inox Control Panel	Glass Control Panel
15 mm	N/A	N/A	N/A	N/A	N/A	N/A		
							Cladding or Laser Cut	Cladding or Laser Cut
17 mm					N/A	N/A	N/A	N/A
	Laser Cut	Laser Cut	Laser Cut	Laser Cut				
50 mm								
	Cladding	Cladding	Cladding or Laser Cut	Cladding or Laser Cut	Laser Cut	Cladding or Laser Cut	Cladding or Laser Cut	Cladding or Laser Cut















DUO Stripe	TRIO Stripe	CORNER	Rustic
Glass Control Panel	Glass Control Panel	Glass Control Panel	Glass Control Panel
Laser Cut	Laser Cut	Laser Cut	Cladding

	Add-on Types for Built-in Cookers							
	I Type Add_on		U Type		O Type		Mono Stripe	
	Inox Control Panel	Glass Control Panel	Metal Control Panel	Glass Control Panel	Metal Control Panel	Glass Control Panel	Metal Control Panel	Glass Control Panel
17 mm	N/A	N/A			N/A	N/A	N/A	N/A
			Laser Cut	Laser Cut				
40 mm							N/A	N/A
	Cladding	Cladding	Cladding	Cladding	Cladding	Cladding		
50 mm	N/A	N/A	N/A	N/A	N/A	N/A		
							Cladding	Cladding



SIDE CONTROLLED HOBS		ENAMELLED PAN SUPPORTS			CAST IRON PAN SUPPORTS			
		S-type	V-type	D-type	S-type Cast Iron	W-type Cast Iron	K-type Cast Iron	Extenda Cast Iron
		0°	0°	0°	0°	45°	45°	0°
FLAT (R, S type)						N/A	N/A	N/A
FLAT (T type)						N/A	N/A	
SURFACE						N/A	N/A	N/A
SMOOTHLINE					N/A	N/A	N/A	N/A
NEW BULIT-IN						N/A	N/A	N/A
DIVISION		N/A	N/A	N/A		N/A	N/A	N/A

SIDE CONTROLLED GAS SECURIT HOBS		ENAMELLED PAN SUPPORTS			CAST IRON PAN SUPPORTS				
		Mono, Standard	Mono, Plusx	Mono, Profile	Mono Cast Iron	Mono Cast, Plusx	Line Cast Iron	Deluxe Cast Iron	S-type Cast Iron
		45°	45°	45°	45°	45°	0°	45°	0°
SECURIT II 4G		✓	✓	✓	✓	✓	N/A	N/A	N/A
SECURIT II		✓	✓	✓	✓	N/A	N/A	N/A	N/A
SECURIT II TRIO		✓	✓	✓	N/A	✓	N/A	N/A	N/A
PURE DESIGN 2GAS+2 VITRO		✓	✓	✓	✓	✓	N/A	N/A	N/A
PURE DESIGN 3GAS+1 VITRO		✓	✓	✓	✓	✓	N/A	N/A	N/A
PURE DESIGN 2GAS+2 IND		✓	✓	✓	✓	✓	N/A	N/A	N/A
DIVISION		N/A	N/A	N/A	N/A	N/A	N/A	N/A	✓

Knob Limitation Table Built-in Cookers					
		BUILT-IN	Side Controlled HOB	Front Controlled HOB	DOMINO S-I / S-II
ALFA		✓	✓	✓	✓
ANTERO		✓	✓	✓	✓
MACRO		✓	✓	✓	Not suitable for Domino range. (Alternative - Small Macro)
RIMO		✓	✓	✓	✓
TRIO		✓	✓	✓	✓
ECLIPSE		✓	✓	✓	✓
FEROUS		✓	✓	✓	✓
GAMA		✓	✓	Height of knob is not suitable for FC range	✓
JANNU		✓	✓	✓	✓
NORD		✓	✓	Height of knob is not suitable for FC range	✓
PIPO		✓	Pop in-Pop out mechanism is not available for Hob range.	Pop in-Pop out mechanism is not available for Hob range.	Pop in-Pop out mechanism is not available for Domino range.
RUSTIC		✓	✓	Height of knob is not suitable for FC range	✓
ZENITH		✓	✓	Knob with ring Not applicable to Hob range	✓
FLAT		✓	✓	✓	✓
FLAT PIPO		✓	✓	✓	✓
LINEA		✓	✓	✓	✓
PRIMUS		✓	✓	✓	✓

# INSTALLATION OF 60 CM BUILT-IN OVEN

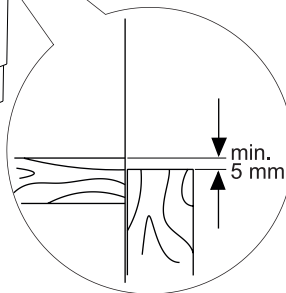
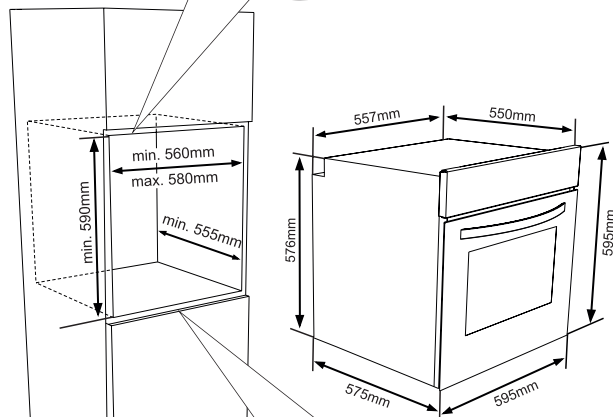
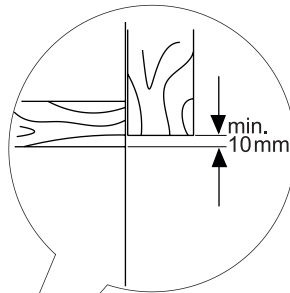
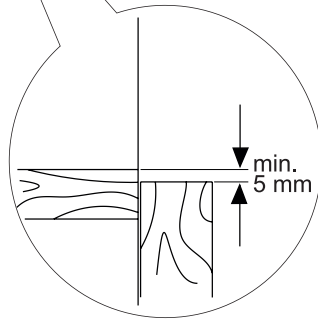
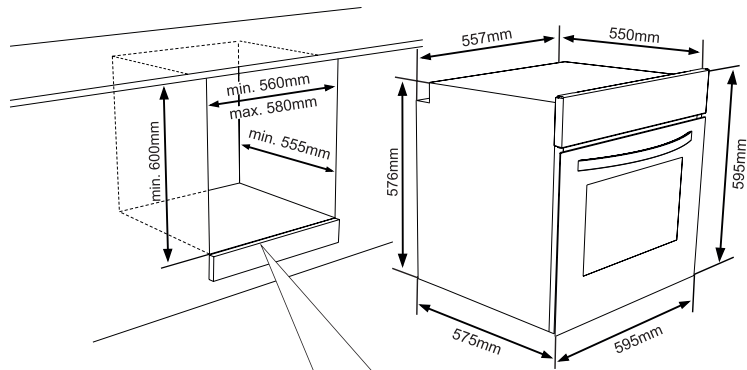

## INSTALLATION OF POLYVALENTE BUILT-IN COOKER SET

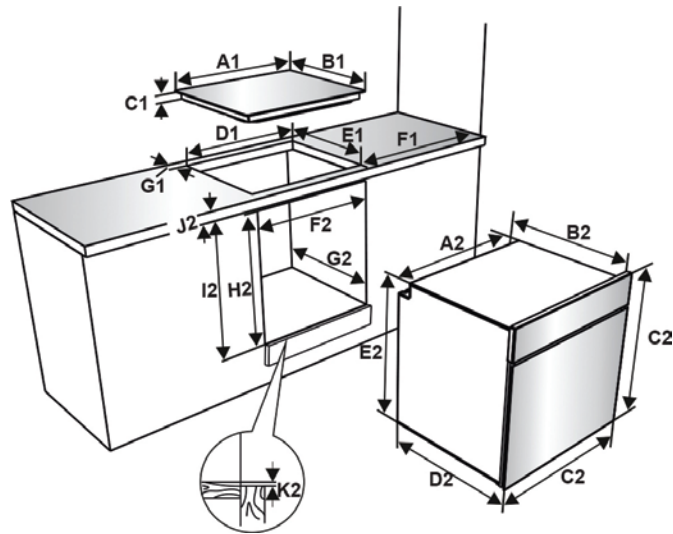

### Installation dimensions for hob

	Vitroc ceramic	Induction	Hotplate
A1 (mm)	590	590	580
B1 (mm)	520	520	510
C1 (mm)	41	56	40
D1 (mm)	560	560	560
E1 (mm)	490	490	490
F1 (mm)	min. 50	min. 50	min. 50
G1 (mm)	min. 50	min. 50	min. 50

### Installation dimensions for oven

A2 (mm)	557	G2 (mm)	min. 555
B2 (mm)	550	H2 (mm)	590
C2 (mm)	595	I2 (mm)	600
D2 (mm)	575	J2 (mm)	25
E2 (mm)	576	K2 (mm)	2
F2 (mm)	min. 560-580		



## INSTALLATION OF BUILT-IN HOB

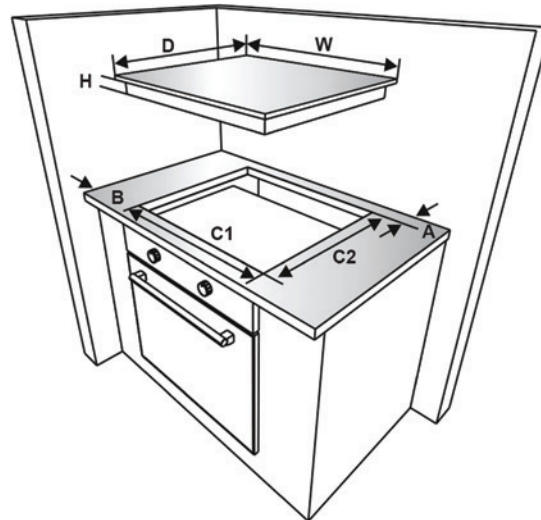

Product Types	Size	Aesthetic	W (mm)	D (mm)	H (mm)	C1 (mm)	C2 (mm)	Min A (mm)	Min B (mm)
Domino Hobs	30 cm	Gas Serie 2	510	290	42,5	270	490	50	50
	30 cm	Electric Serie 2	510	290	42,5	270	490	50	50
	30 cm	Securit Serie 1	520	290	47,5	270	490	50	50
	30 cm	Securit Serie 2	510	290	47,5	270	490	50	50
	30 cm	Vitro Ceramic Serie 1	520	290	47,5	270	490	50	50
	30 cm	Vitro Ceramic Serie 2	510	290	47,5	270	490	50	50
	30 cm	Vestel Induction Serie 1	520	290	56	270	490	50	50
	30 cm	Vestel Induction Serie 2	510	290	56	270	490	50	50
Gas on Glass Hobs	60 cm	Securit 2 / Securit 2 Trio / Division	594	523	44	560	490	50	50
	60 cm	PlusX	590	520	44	560	490	50	50
	60 cm	Pure, Gas+Vitro Ceramic/ Gas+Induction Ceramic	590	520	52	560	490	50	50
	70 cm	PlusX	700	520	44	560	490	50	50
	75 cm	Standard 75x45 2Wok	750	450	53	690	380	50	50
	90 cm	PlusX	882	520	47	850	490	50	50
Gas/ Combined/ Electric Hobs	60 cm	Flat / Surface / Extenda / Classic / Division	580	510	40	560	490	50	50
	60 cm	PlusX	580	515	42	560	490	50	50
	70 cm	PlusX	700	515	42	560	490	50	50
Vitro Ceramic Hobs	60 cm	C Serie with touch controlled	590	520	41	560	490	50	50
	60 cm	C Serie with knob controlled	590	520	47,5	560	490	50	50
	78 cm	C Serie	780	520	41	750	490	50	50
Induction Ceramic Hobs	60 cm	Vestel Induction	590	520	54	560	490	50	50
	78 cm	Vestel Induction	780	520	54	750	490	50	50
	90 cm	Vestel Induction	890	520	54	860	490	50	50
	78 cm	Vestel Induction	780	520	56	750	490	50	50
	90 cm	Vestel Induction	890	520	56	860	490	50	50
Domino Gas Hobs	30 cm	Gas Serie 2	510	290	42,5	270	490	50	100
Domino Electric Hobs	30 cm	Electric Serie 2	510	290	42,5	270	490	50	50
Domino Gas on Glass Hobs	30 cm	Securit Serie 1	520	290	47,5	270	490	50	100
	30 cm	Securit Serie 2	510	290	47,5	270	490	50	100
Domino Vitro Ceramic Hobs	30 cm	Vitro Ceramic Serie 1	520	290	47,5	270	490	50	50
	30 cm	Vitro Ceramic Serie 2	510	290	47,5	270	490	50	50
Domino Induction Ceramic Hobs	30 cm	Vestel Induction Serie 1	520	290	56	270	490	50	50
	30 cm	Vestel Induction Serie 2	510	290	56	270	490	50	50





**Vestel Trade Co.**

Organize Sanayi Bolgesi, 45030 Manisa/Turkey

**Phone:** 90 - 236 233 25 82

**Fax:** 90 - 236 233 25 84

vesteltrade@vestel.com.tr

www.vestelinternational.com

**Vestel Germany GmbH**

Parkring 6 D-85748 Garching  
bei München/Germany

**Phone:** 49 - 89 55295 - 0

**Fax:** 49 - 89 55295 - 2000

info@vestel-germany.de

www.vestel-germany.de

**Vestel UK Ltd**

Vestel House, Waterside Drive  
Langley, Berkshire SL3 6EZ

**Phone:** 44 - 3330 146 400

info@vestel-uk.com

www.vestel.co.uk

**Vestel France SASU**

17 Rue de la Couture - Parc Icade  
BP 10190 - 94563 RUNGIS Cedex/France

**Phone:** 33 - 1 46 75 00 29

**Fax:** 33 - 1 41 80 99 31

info@vestel.fr

www.vestel-france.fr

**Vestel Benelux B.V.**

Stationsplein 45, A1-194  
3013 AK Rotterdam,

The Netherlands

**Phone:** 31 - 10 235 1005

info@vestelbenelux.nl

www.vestelbenelux.nl

**Vestel Iberia, S. L.**

Paeso Doce Estrellas, 2, 3o. 28042. Madrid, Spain

**Phone:** 34 - 91 320 63 98

**Fax:** 34 - 91 320 52 58

vestel@vestel.es

www.vestel.es

**Vestel CIS Ltd.**

1-st Graivoronovsky Proezd, No.20 Building 16,  
109518, Moscow /Russia

**Phone:** 7 - 095 956 8230

**Fax:** 7 - 095 956 8233

info@vestel.ru

www.vestel.ru

**Vestel Electronics Gulf DMCC**

Unit No: ALMAS-06-C ALMAS Tower Plot  
No: JLT-PH1-A0

Jumeirah Lakes Towers Dubai Bae

info@vestel-gulf.ae

www.vestel-gulf.ae

**TOO Vestel Central Asia**

050026 Kazakhsatan/Almaty Aiteke bi 187,  
office: 215

**Phone:** 7 - 727 263 39 39

info@vestel.kz

**Vestel Poland Sp. z o.o.**

ul. Salsy 2, 02-822 Warszawa, Polska

**Phone:** 48 22 272 73 11

info@vestel-poland.com

www.vestel-poland.com

**Vestel Electronica**

Bucharest, 1st District, 2-4 Murmurului Entrance,  
014114 Bucharest/Romania

**Phone:** 40 - 31 425 42 93

**Fax:** 40 -31 425 42 95

office@vestel.ro

www.vestel.ro





# VESTEL

Organize Sanayi Bolgesi, 45030 Manisa/Turkey  
**Phone:** 90 - 236 233 25 82 **Fax:** 90 - 236 233 25 84  
vesteltrade@vestel.com.tr · www.vestelinternational.com

*Follow us on social media:*



/vestelinternational